

Elektrisch bediend
2-Weg NC
Messing magneetventiel

SIRAI L182 HN



Sirai L182 HN

Sirai L182 HN, Elektrisch bediend indirect werkend 2/2-weg messing magneetventiel NC (normaal gesloten) voorzien van hand nood bediening.

DOORLAAT

DN13,5 (3/8") tot DN24 (1")

AANSLUITING

- 2-Zijdig binnendraad volgens UNI EN 10226 (DIN ISO 7/1)

BEDRIJFSDRUK

Maximaal 20bar

TEMPERATUUR MEDIUM

Van:

- 10° tot +90°C (NBR)
- 0° tot +130°C (FPM)
- 10° tot +140°C (EPDM)

MATERIAAL

Huis: Messing
Membraan: NBR, EPDM of FPM
Inwendige delen: Messing en RVS
Kerngeleidebuis: RVS
Kortsluitring: Koper

DOORSTROMINGSRICHTING

Van P naar A.

MONTAGE

Magneetventiel kan in elke positie gemonteerd worden, voorkeur montage met de spoel verticaal naar boven gericht.

MEDIUM

Neutrale gasen en vloeistoffen. Voor toepassingen met agressieve media bestendigheidstabel raadplegen.

TECHNISCHE SPECIFICATIES

- Maximaal toelaatbare druk: 20bar
- Openigstijd: van ~300ms tot ~1500ms
- Sluittijd: van ~1000ms tot ~2000ms
- Maximale viscositeit: 5°E (~37 cStokes of mm²/s)

SIRAI L182 HN

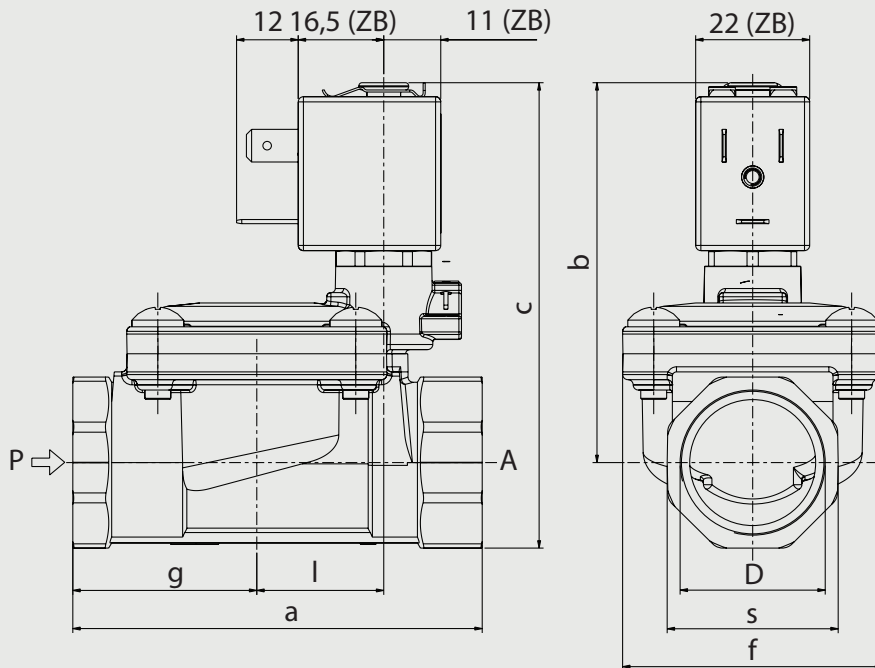

2/2 NC, NBR, 000/00

Sirai L182 2/2 weg indirectwerkend magneetventiel body elektrisch bediend 00 volt AC/DC

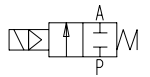

Doorlaat[mm] aansluiting[mm]		Druk (min)	Druk (max) Gas	Druk (max) Vloeistof	Kv	Spoel	Vermogen	Inbouwmaat [mm] en gewicht [kg]							Bestelcode	
DN	Rp							a	b	c	f	g	l	s		Gewicht
13,5	3/8	0,35	16	16	2,5			60	66	77	40	25,5	20	22	0,32	SL182B2CY
13,5	1/2	0,35	12	12	3,8			66	69	83	40	29	20	27	0,38	SL182B2DY
18	3/4	0,35	12	12	5			79	72,5	89	50	35,5	24,5	33	0,52	SL182B2EY
24	1	0,35	12	12	12			105	85	106	71	46	28	42	1,08	SL182B2FY

2/2 NC, NBR, 024V/DC

Sirai L182 2/2 weg indirectwerkend magneetventiel elektrisch bediend 24 volt DC

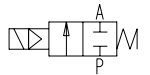

Doorlaat[mm] aansluiting[mm]		Druk (min)	Druk (max) Gas	Druk (max) Vloeistof	Kv	Spoel	Vermogen	Inbouwmaat [mm] en gewicht [kg]							Bestelcode	
DN	Rp							a	b	c	f	g	l	s		Gewicht
13,5	3/8	0,35	16	16	2,5	ZB10A	5,5W	60	66	77	40	25,5	20	22	0,32	SL182B2CYB10E2A
13,5	1/2	0,35	12	12	3,8	ZB10A	5,5W	66	69	83	40	29	20	27	0,38	SL182B2DYB10D2A
13,5	1/2	0,35	12	12	3,8	ZB10A	5,5W	66	69	83	40	29	20	27	0,38	SL182B2DYB10E2A
13,5	1/2	0,35	12	12	3,8	ZB14A	5,5W	66	69	83	40	29	20	27	0,38	SL182B2DYB14E2A
18	3/4	0,35	12	12	5	ZB10A	5,5W	79	72,5	89	50	35,5	24,5	33	0,52	SL182B2EYB10E2A
18	3/4	0,35	12	12	5	ZB12A	5,5W	79	72,5	89	50	35,5	24,5	33	0,52	SL182B2EYB12E2A
24	1	0,35	12	12	12	ZB10A	5,5W	105	85	106	71	46	28	42	1,08	SL182B2FYB10E2A

SIRAI L182 HN

2/2 NC, NBR, 024V/50-60Hz

Sirai L182 2/2 weg indirectwerkend magneetventiel elektrisch bediend 24 volt AC

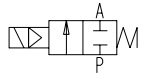

Doorlaat[mm] aansluiting[mm]		Druk (min)	Druk (max) Gas	Druk (max) Vloeistof	Kv	Spoel	Vermogen	Inbouwmaat [mm] en gewicht [kg]								Bestelcode
DN	Rp							a	b	c	f	g	l	s	Gewicht	
13,5	3/8	0,35	16	16	2,5	ZB10A	12-6VA 4W	60	66	77	40	25,5	20	22	0,32	SL182B2CYB10E7A
13,5	3/8	0,35	16	16	2,5	ZB12A	12-6VA 4W	60	66	77	40	25,5	20	22	0,32	SL182B2CYB12E7A
13,5	1/2	0,35	12	12	3,8	ZB10A	12-6VA 4W	66	69	83	40	29	20	27	0,38	SL182B2DYB10E7A
18	3/4	0,35	12	12	5	ZB10A	12-6VA 4W	79	72,5	89	50	35,5	24,5	33	0,52	SL182B2EYB10E7A
24	1	0,35	12	12	12	ZB10A	12-6VA 4W	105	85	106	71	46	28	42	1,08	SL182B2FYB10E7A

2/2 NC, NBR, 230V/50-60Hz

Sirai L182 2/2 weg indirectwerkend magneetventiel elektrisch bediend 230 volt AC

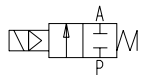

Doorlaat[mm] aansluiting[mm]		Druk (min)	Druk (max) Gas	Druk (max) Vloeistof	Kv	Spoel	Vermogen	Inbouwmaat [mm] en gewicht [kg]								Bestelcode
DN	Rp							a	b	c	f	g	l	s	Gewicht	
13,5	3/8	0,35	16	16	2,5	ZB10A	12-6VA 4W	60	66	77	40	25,5	20	22	0,32	SL182B2CYB10S7A
13,5	1/2	0,35	12	12	3,8	ZB10A	12-6VA 4W	66	69	83	40	29	20	27	0,38	SL182B2DYB10S7A
13,5	1/2	0,35	12	12	3,8	ZB12A	12-6VA 4W	66	69	83	40	29	20	27	0,38	SL182B2DYB12S7A
18	3/4	0,35	12	12	5	ZB10A	12-6VA 4W	79	72,5	89	50	35,5	24,5	33	0,52	SL182B2EYB10S7A
24	1	0,35	12	12	12	ZB10A	12-6VA 4W	105	85	106	71	46	28	42	1,08	SL182B2FYB10S7A

2/2 NC, FPM, 000/00

Sirai L182 2/2 weg indirectwerkend magneetventiel body elektrisch bediend 00 volt AC/DC

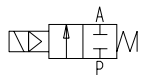

Doorlaat[mm] aansluiting[mm]		Druk (min)	Druk (max) Gas	Druk (max) Vloeistof	Kv	Spoel	Vermogen	Inbouwmaat [mm] en gewicht [kg]								Bestelcode
DN	Rp							a	b	c	f	g	l	s	Gewicht	
13,5	3/8	0,35	16	16	2,5			60	66	77	40	25,5	20	22	0,32	SL182V2CY
13,5	1/2	0,35	12	12	3,8			66	69	83	40	29	20	27	0,38	SL182V2DY
18	3/4	0,35	12	12	5			79	72,5	89	50	35,5	24,5	33	0,52	SL182V2EY
24	1	0,35	12	12	12			105	85	106	71	46	28	42	1,08	SL182V2FY

2/2 NC, FPM, 024V/DC

Sirai L182 2/2 weg indirectwerkend magneetventiel elektrisch bediend 24 volt DC

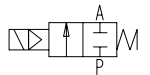

Doorlaat[mm] aansluiting[mm]		Druk (min)	Druk (max) Gas	Druk (max) Vloeistof	Kv	Spoel	Vermogen	Inbouwmaat [mm] en gewicht [kg]								Bestelcode
DN	Rp							a	b	c	f	g	l	s	Gewicht	
13,5	3/8	0,35	16	16	2,5	ZB10A	5,5W	60	66	77	40	25,5	20	22	0,32	SL182V2CYB10E2A
13,5	1/2	0,35	12	12	3,8	ZB10A	5,5W	66	69	83	40	29	20	27	0,38	SL182V2DYB10E2A
13,5	1/2	0,35	12	12	3,8	ZB12A	5,5W	66	69	83	40	29	20	27	0,38	SL182V2DYB12E2A
18	3/4	0,35	12	12	5	ZB10A	5,5W	79	72,5	89	50	35,5	24,5	33	0,52	SL182V2EYB10E2A
24	1	0,35	12	12	12	ZB10A	5,5W	105	85	106	71	46	28	42	1,08	SL182V2FYB10E2A

SIRAI L182 HN

2/2 NC, FPM, 024V/50-60Hz

Sirai L182 2/2 weg indirectwerkend magneetventiel elektrisch bediend 24 volt AC

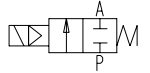

Doorlaat[mm] aansluiting[mm]		Druk (min)	Druk (max) Gas	Druk (max) Vloeistof	Kv	Spoel	Vermogen	Inbouwmaat [mm] en gewicht [kg]								Bestelcode
DN	Rp							a	b	c	f	g	l	s	Gewicht	
13,5	3/8	0,35	16	16	2,5	ZB10A	12-6VA 4W	60	66	77	40	25,5	20	22	0,32	SL182V2CYB10E7A
13,5	1/2	0,35	12	12	3,8	ZB10A	12-6VA 4W	66	69	83	40	29	20	27	0,38	SL182V2DYB10E7A
18	3/4	0,35	12	12	5	ZB10A	12-6VA 4W	79	72,5	89	50	35,5	24,5	33	0,52	SL182V2EYB10E7A
24	1	0,35	12	12	12	ZB10A	12-6VA 4W	105	85	106	71	46	28	42	1,08	SL182V2FYB10E7A

2/2 NC, FPM, 230V/50-60Hz

Sirai L182 2/2 weg indirectwerkend magneetventiel elektrisch bediend 230 volt AC

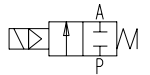

Doorlaat[mm] aansluiting[mm]		Druk (min)	Druk (max) Gas	Druk (max) Vloeistof	Kv	Spoel	Vermogen	Inbouwmaat [mm] en gewicht [kg]								Bestelcode
DN	Rp							a	b	c	f	g	l	s	Gewicht	
13,5	3/8	0,35	16	16	2,5	ZB10A	12-6VA 4W	60	66	77	40	25,5	20	22	0,32	SL182V2CYB10S7A
13,5	1/2	0,35	12	12	3,8	ZB10A	12-6VA 4W	66	69	83	40	29	20	27	0,38	SL182V2DYB10S7A
18	3/4	0,35	12	12	5	ZB10A	12-6VA 4W	79	72,5	89	50	35,5	24,5	33	0,52	SL182V2EYB10S7A
24	1	0,35	12	12	12	ZB10A	12-6VA 4W	105	85	106	71	46	28	42	1,08	SL182V2FYB10S7A