



Mens, Maatwerk & Techniek
Professionals in Flow & Fluid Technology

Bestel eenvoudig uw persluchtproducten
Zowel offline als online
30.000 producten!



Perslucht Catalogus 2017
Ook online www.aimfluid.nl



MENS, MAATWERK & TECHNIEK



















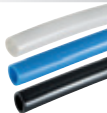

Professionals in Flow & Fluid Technology

Gewoon

www.aimfluid.nl

| ALS JE DOOR DE BOMEN HET BOS NIET MEER ZIET |

aim biedt uitkomst

	Pagina 698	PVC slangen		Pagina 726	PU & PA spiraalslangen
	Pagina 703	Waterslangen		Pagina 731	Buizen - koper, aluminium, PA & PEX
	Pagina 705	Werkplaatsslangen		Pagina 732	Compensatoren
	Pagina 708	PU slangen		Pagina 733	Leidingknippers
	Pagina 710	PA slangen		Pagina 734	Staalomvlochten slang & accessoires
	Pagina 713	PE slangen		Pagina 736	Slangpers
	Pagina 715	Layflat slangen		Pagina 738	Slangpilaren
	Pagina 717	Zuigslangen		Pagina 753	Slangklemmen
	Pagina 722	Afzuigslangen		Pagina 766	Buis koppelingen
	Pagina 725	PTFE slangen		Pagina 768	Slanghaspels



PVC slangen

Textielversterkte PVC slangen Type RPVC & HDPVC

Gemaakt van hoogwaardig, transparant, niet gerecycled PVC materiaal. Geschikt voor vele industriële toepassingen, bestand tegen een hoge werkdruk. Zeer flexibele slang, versterkt met polyestervezel.

Deze slang is bestand tegen vele chemicaliën. Meer informatie over de bestendigheid is te vinden in de bestendigheidstabel achterin dit hoofdstuk.

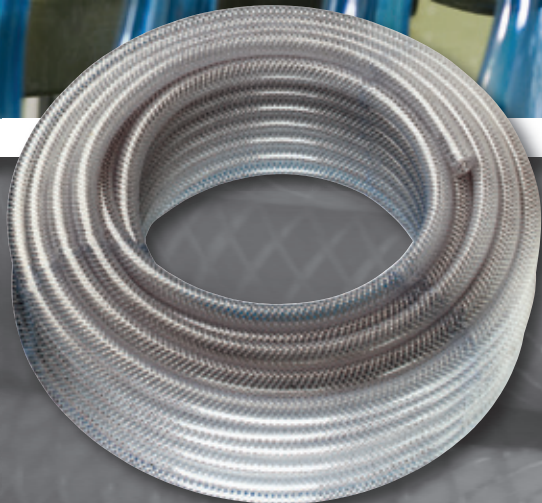

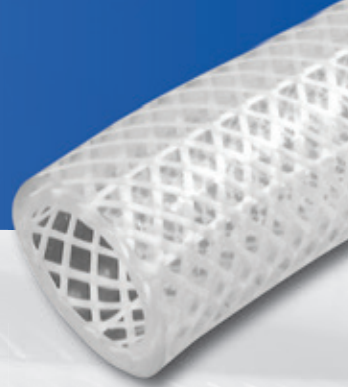

Toepassing:

- Toevoer en afvoer van water
- Doorvoer van diverse vloeibare stoffen en poeders
- Aanvoer van water, gas en olie in landbouw en industrie

Lengtes*	10m	20m	30m	50m	100m
Temperatuur	Min -20°C		Max +65°C		

*Overige lengtes op aanvraag leverbaar.

Eigenschappen:

- Zeer slijtvast
- Goede flexibiliteit
- Hoge weerstand tegen alkaline en zuren
- Siliconenvrij
- Cadmiumvrij
- Niet giftig
- Uitstekende transparantie
- Gefabriceerd volgens BS6066 & ISO5774 met FDA gekeurde materialen
- Lichtgewicht en makkelijk in gebruik
- Geen splijting door UV-straling of direct zonlicht
- Nagenoeg geen inkrimping of uitzetting



Tech Data 1884

HDPVC heavy duty slang

Zeer slijtvaste en flexibele slang.
Gefabriceerd volgens BS6066 en ISO5774. Voldoet aan US FDA standaard (voedingsmiddelen).
Veiligheidsfactor: 3
De aangegeven druk is gebaseerd op een temperatuur van 20°C.

Temperatuur:
-20°C tot +65°C

! Iedere temperatuurverhoging boven 20°C heeft een negatief effect op de drukbestendigheid.



Flexibel - met textielinlage - 10 meter rol

PVC	ID mm	-ID-	OD mm	Material	Bar	€
HDPVC516-10	8	5/16"	13.5	Transparant	16	18.75
HDPVC38-10	10	3/8"	16	Transparant	15	13.75

Flexibel - met textielinlage - 20 meter rol

PVC	ID mm	-ID-	OD mm	Material	Bar	€
HDPVC516-20	8	5/16"	13.5	Transparant	16	37.55
HDPVC38-20	10	3/8"	16	Transparant	15	27.55

Flexibel - met textielinlage - 30 meter rol

PVC	ID mm	-ID-	OD mm	Material	Bar	€
HDPVC14	6.5	1/4"	11.5	Transparant	16	24.20
HDPVC14B	6.5	1/4"	11.5	Blauw	16	24.20
HDPVC14N	6.5	1/4"	11.5	Zwart	16	24.20
HDPVC14R	6.5	1/4"	11.5	Rood	16	24.20
HDPVC516	8	5/16"	13.5	Transparant	16	46.90
HDPVC516B	8	5/16"	13.5	Blauw	16	46.90
HDPVC516N	8	5/16"	13.5	Zwart	16	46.90
HDPVC516Y	8	5/16"	13.5	Geel	16	46.90
HDPVC38	10	3/8"	16	Transparant	15	41.45
HDPVC38B	10	3/8"	16	Blauw	15	41.45
HDPVC38N	10	3/8"	16	Zwart	15	41.45
HDPVC38R	10	3/8"	16	Rood	15	41.45
HDPVC38Y	10	3/8"	16	Geel	15	41.45
HDPVC12	12.5	1/2"	18.5	Transparant	12	47.10
HDPVC12B	12.5	1/2"	18.5	Blauw	12	47.10
HDPVC12N	12.5	1/2"	18.5	Zwart	12	47.10
HDPVC12R	12.5	1/2"	18.5	Rood	12	47.10
HDPVC12Y	12.5	1/2"	18.5	Geel	12	47.10
HDPVC58	16	5/8"	23	Transparant	10	73.55
HDPVC34	20	3/4"	26	Transparant	10	68.85
HDPVC34B	20	3/4"	26	Blauw	10	74.40
HDPVC34N	20	3/4"	26	Zwart	10	74.40
HDPVC1	25	1"	33	Transparant	10	115.90
HDPVC114	32	1.1/4"	41	Transparant	6	185.05
HDPVC112	40	1.1/2"	49	Transparant	6	219.50
HDPVC2	50	2"	62	Transparant	3	381.45

Flexibel - met textielinlage - 50 meter rol

PVC	ID mm	-ID-	OD mm	Material	Bar	€
HDPVC38-50	10	3/8"	16	Transparant	15	69.10
HDPVC12-50	12.5	1/2"	18.5	Transparant	12	78.55
HDPVC58-50	16	5/8"	23	Transparant	10	122.55
HDPVC58N-50	16	5/8"	23	Zwart	10	122.55
HDPVC34-50	20	3/4"	26	Transparant	10	114.80
HDPVC34N-50	20	3/4"	26	Zwart	10	124.05
HDPVC1-50	25	1"	33	Transparant	10	193.15
HDPVC1N-50	25	1"	33	Zwart	10	193.15
HDPVC1B-50	25	1"	33	Blauw	10	193.15

Flexibel - met textielinlage - 100 meter rol

PVC	ID mm	-ID-	OD mm	Material	Bar	€
HDPVC14-100	6.5	1/4"	11.5	Transparant	16	80.75
HDPVC14N-100	6.5	1/4"	11.5	Zwart	16	80.75
HDPVC516-100	8	1/4"	13.5	Transparant	16	93.85
HDPVC516B-100	8	5/16"	13.5	Blauw	16	93.85

- Voor drukknop veiligheidsnetkoppelingen conform ARB0/ISO 4414 zie pagina 257 en 262
- Met Euro, Orion & ISO 6150-C profiel

PVC slangen



Tech Data 1884

RPVC medium duty slang

Temperatuur:
-20°C tot +65°C

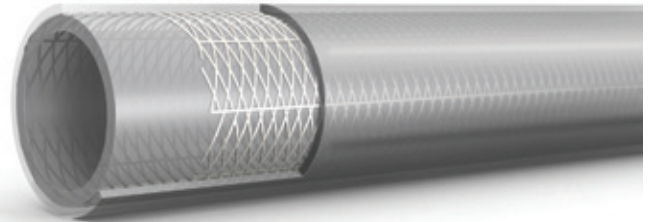

Flexibel - met textielinlage - 15 meter rol

PVC	ID mm	-ID-	OD mm	bar	€	
RPVC12-15	13	1/2"	18	Transparant	12	18.70
RPVC34-15	19	3/4"	25	Transparant	10	32.60
RPVC114-15	32	1.1/4"	40	Transparant	6	73.50
RPVC112-15	38	1.1/2"	42	Transparant	6	85.85
RPVC2-15	50	2"	60	Transparant	3	141.70

Flexibel - met textielinlage - 30 meter rol

PVC	ID mm	-ID-	OD mm	bar	€	
RPVC316-30	5	3/16"	10	Transparant	13	20.10
RPVC316N-30	5	3/16"	10	Zwart	13	20.10
RPVC14-30	6	1/4"	11	Transparant	15	21.45
RPVC14N-30	6	1/4"	11	Zwart	15	21.45
RPVC14R-30	6	1/4"	11	Rood	15	21.45
RPVC14B-30	6	1/4"	11	Blauw	15	21.45
RPVC14G-30	6	1/4"	11	Groen	15	21.45
RPVC14Y-30	6	1/4"	11	Geel	15	21.45
RPVC516-30	8	5/16"	13	Transparant	15	25.45
RPVC516N-30	8	5/16"	13	Zwart	15	25.45
RPVC516R-30	8	5/16"	13	Rood	15	25.45
RPVC516B-30	8	5/16"	13	Blauw	15	25.45
RPVC516G-30	8	5/16"	13	Groen	15	25.45
RPVC38-30	10	3/8"	15	Transparant	12	30.15
RPVC38N-30	10	3/8"	15	Zwart	12	30.15
RPVC38R-30	10	3/8"	15	Rood	12	30.15
RPVC38B-30	10	3/8"	15	Blauw	12	30.15
RPVC38G-30	10	3/8"	15	Groen	12	30.15
RPVC38Y-30	10	3/8"	15	Geel	12	30.15
RPVC12-30	13	1/2"	18	Transparant	12	37.45
RPVC12N-30	13	1/2"	18	Zwart	12	37.45
RPVC12R-30	13	1/2"	18	Rood	12	37.45
RPVC12B-30	13	1/2"	18	Blauw	12	37.45
RPVC12G-30	13	1/2"	18	Groen	12	37.45
RPVC12Y-30	13	1/2"	18	Geel	12	37.45
RPVC58-30	16	5/8"	21	Transparant	10	45.20
RPVC58N-30	16	5/8"	21	Zwart	10	45.20
RPVC34-30	19	3/4"	25	Transparant	10	65.30
RPVC34N-30	19	3/4"	25	Zwart	10	65.25
RPVC34R-30	19	3/4"	25	Rood	10	65.25
RPVC34B-30	19	3/4"	25	Blauw	10	65.25
RPVC1-30	25	1"	31	Transparant	9	81.10
RPVC1N-30	25	1"	31	Zwart	9	81.10
RPVC114-30	32	1.1/4"	40	Transparant	6	147.00
RPVC112-30	38	1.1/2"	42	Transparant	6	171.60
RPVC2-30	50	2"	60	Transparant	3	283.45

Flexibel - met textielinlage - 50 meter rol

PVC	ID mm	-ID-	OD mm	bar	€	
RPVC14N	6	1/4"	11	Zwart	15	37.55
RPVC14B	6	1/4"	11	Blauw	15	37.55
RPVC516	8	5/16"	13	Transparant	15	42.40
RPVC516N	8	5/16"	13	Zwart	15	42.40
RPVC516B	8	5/16"	13	Blauw	15	42.40
RPVC38	10	3/8"	15	Transparant	12	50.45
RPVC38N	10	3/8"	15	Zwart	12	50.45
RPVC38B	10	3/8"	15	Blauw	12	50.45
RPVC12	13	1/2"	18	Transparant	12	62.35
RPVC12N	13	1/2"	18	Zwart	12	62.35
RPVC58	16	5/8"	21	Transparant	10	75.40
RPVC58N	16	5/8"	21	Zwart	10	75.40
RPVC34	19	3/4"	25	Transparant	10	108.65
RPVC34N	19	3/4"	25	Zwart	10	108.65
RPVC1	25	1"	31	Transparant	9	135.10
RPVC1N	25	1"	31	Zwart	9	135.10
RPVC114	32	1.1/4"	40	Transparant	6	245.00

Flexibel - met textielinlage - 100 meter rol

PVC	ID mm	-ID-	OD mm	bar	€	
RPVC14-100	6	1/4"	11	Transparant	15	71.60
RPVC14N-100	6	1/4"	11	Zwart	15	71.60
RPVC14R-100	6	1/4"	11	Rood	15	71.60
RPVC14B-100	6	1/4"	11	Blauw	15	71.60
RPVC14G-100	6	1/4"	11	Groen	15	71.60
RPVC14Y-100	6	1/4"	11	Geel	15	71.60
RPVC516-100	8	5/16"	13	Transparant	15	84.75
RPVC516N-100	8	5/16"	13	Zwart	15	84.75
RPVC516R-100	8	5/16"	13	Rood	15	84.75
RPVC516B-100	8	5/16"	13	Blauw	15	84.75
RPVC38-100	10	3/8"	15	Transparant	12	100.80
RPVC38N-100	10	3/8"	15	Zwart	12	100.80
RPVC38R-100	10	3/8"	15	Rood	12	100.75
RPVC38B-100	10	3/8"	15	Blauw	12	100.80
RPVC38Y-100	10	3/8"	15	Geel	12	100.75
RPVC12-100	13	1/2"	18	Transparant	12	124.80
RPVC12N-100	13	1/2"	18	Zwart	12	124.80
RPVC12R-100	13	1/2"	18	Rood	12	124.80
RPVC12B-100	13	1/2"	18	Blauw	12	124.80
RPVC12Y-100	13	1/2"	18	Geel	12	124.80
RPVC34-100	19	3/4"	25	Transparant	10	217.60
RPVC1-100	25	1"	31	Transparant	9	270.35

Hoofdstuk 13 - Slangen

KELM™
pneumatiek

Hydrauliek

Snel-
koppelingen

Atsluiters

Roestvast
staal

Fittingen

Lucht-
conditionering

Gereedschap

Pneumatiek

Diversen

Malleabele
fittingen
& staal

Ringleiding-
systemen

Slangen

Compressoren

Crystal hogedrukslang

Een flexibele, duurzame, slijtvaste slang met uitstekende chemische resistentie.

Toepasbaar in:

- Land-/tuintbouw
- Garage werkplaatsen
- Pneumatisch luchtgereedschap
- Pneumatische luchtleidingen
- Hogedruktoepassingen

Temperatuur:
-5°C tot +65°C

Maximale werkdruk:
30 bar

Tech Data
10642



Flexibel - met textielinlage - 100 meter rol

PVC					
CHPBH14	6.3	1/4"	13.2	30	148.75

CPVC heldere slang

Zuiver PVC, gemaakt van zeer hoogwaardige kwaliteit kristalhelder PVC mengsel.

Deze slang is ideaal voor het transporteren van vloeistof, gassen, poeders en granulaten bij lage druk.

Alle slangen gemaakt van USF en DA gekeurd materiaal, geschikt voor voedingsmiddelen.

Opmerking: omdat deze slang onversterkt is wordt er geen geadviseerde werkdruk of barstdruk opgegeven.

Temperatuur:
-15°C tot +60°C

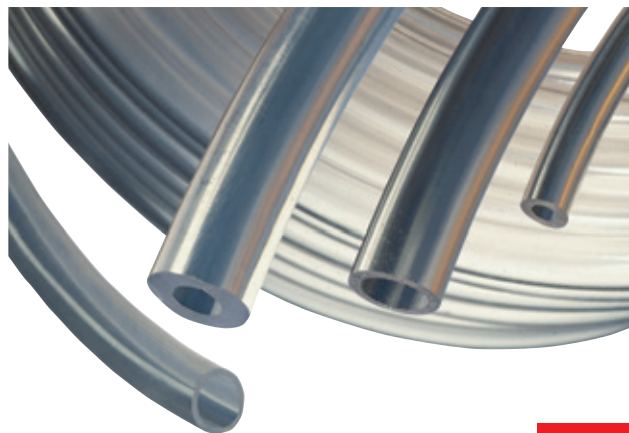

Light duty - food - zonder inlage - 30 meter rol

Tech Data
20204

PVC				
CPVC18/15	3	1/8"	5	5.55
CPVC532/10	4	5/32"	6	6.30
CPVC316/15	5	3/16"	7	6.80
CPVC14/15	6	1/4"	8	7.75
CPVC516/15	8	5/16"	11	16.20
CPVC38/15	9	3/8"	12	16.55
CPVC12/15	12	1/2"	15	23.15
CPVC34/15	19	3/4"	22.5	41.15

Medium duty - food - zonder inlage - 30 meter rol

Tech Data
20205

PVC				
CPVC5/11	5	3/16"	11	23.40
CPVC6/12	6	1/4"	12	30.75
CPVC8/14	8	5/16"	14	34.20
CPVC10/16	10	3/8"	16	42.10
CPVC12/18	12	1/2"	18	47.25
CPVC16/22	16	5/8"	22	66.00
CPVC19/25	19	3/4"	25	76.95
CPVC25/31	25	1"	31	94.45

- **tst** (drukknop) snelkoppelingen & insteeknippels vanaf pagina 257





HDPVC FOOD slang BS6066 & ISO5774

FHDPVC12



12.5X18.5

Tech Data
10168

Deze flexibele, gladde & corrosiebestendige voedingsmiddelenslang is geproduceerd uit grondstoffen die voldoen aan de FDA eisen.

De slang heeft dezelfde basiseigenschappen als heldere PVC slang zonder inlage, maar is sterker en flexibeler en daardoor ideaal voor installaties waar ruimte beperkt is.

Volledig getest en gecertificeerd & voorzien van Food Safe logo.

Toepassingen:

- Levensmiddelen
- Bier
- Koelvloeistof
- Olie
- Gas
- Droge poeders en korrels

Beschikbare lengtes:
30 en 100 meter

Beschikbare maten:
1/4" tot 2" inwendige diameter

Eigenschappen:

- Zeer slijtvast
- Goede flexibiliteit
- Hoge weerstand tegen alkaline en zuren
- Siliconenvrij
- Cadmiumvrij
- Niet giftig
- Uitstekende transparantie
- Gefabriceerd volgens BS6066 & ISO5774

- FDA keurmerk
- Duurzaam en bestand tegen kou
- Lichtgewicht en makkelijk in gebruik
- Geen splinging door UV-straling of direct zonlicht
- Nagenoeg geen inkrimping of uitzetting

HDPVC heavy duty heldere FOOD slang



Temperatuur:
-20°C tot +65°C

Flexibel - food - met textielinlage - 30 meter rol

PVC	ID mm	ID	OD mm	bar	€
FHDPVC14	6.5	1/4"	11.5	16	29.70
FHDPVC516	8	5/16"	13.5	16	36.30
FHDPVC38	10	3/8"	16	15	47.55
FHDPVC12	12.5	1/2"	18.5	12	52.35
FHDPVC34	20	3/4"	26	10	85.40
FHDPVC1	25	1"	33	10	129.40
FHDPVC114	32	1.1/4"	41	6	175.80
FHDPVC112	40	1.1/2"	49	6	255.60
FHDPVC2	50	2"	62	3	416.35

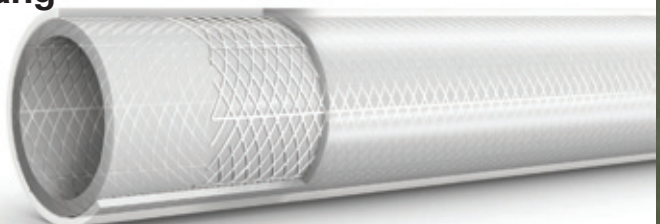

Flexibel - food - met textielinlage - 100 meter rol

PVC	ID mm	ID	OD mm	bar	€
FHDPVC14-100	6.5	1/4"	11.5	16	98.70
FHDPVC516-100	8	5/16"	13.5	16	121.00
FHDPVC38-100	10	3/8"	16	15	158.25
FHDPVC12-100	12.5	1/2"	18.5	12	174.60
FHDPVC34-100	20	3/4"	26	10	284.50

Hi-Vis RPVC medium duty slang water & perslucht



De **Hi-Vis** eigenschappen van deze slang zijn volledig conform Health & Safety (Chromaticity Luminance) NEN-EN-ISO 5774 & EN471: 2003, een must voor alle professionele faciliteiten en toepassingen.

Eigenschappen:

- 20 bar werkdruk
- -20 °C tot +80 °C
- Geschikt voor drinkwater
- Zelfdovend
- Hoge zichtbaarheid
- Flexibele PVC
- UV-bestendig
- Multifunctioneel
- Witte binnenzijde, fluorescerend gele buitenzijde
- Materiaal zachtheid BSS50/BSS65

Toepassingen:

- Industrie
- Voedingsmiddelen
- Reiniging
- Garages
- Werkplaatsen
- Glasbewassing / hoogbouw
- Festivals en openlucht evenementen



De componenten gebruikt in de productie van deze slang zijn conform de CE-en FDA-eisen.

Geldende normen NEN-EN-ISO 5774 (kunststof slangen, textielversterkte types voor persluchttoepassingen.)
Getest volgens EN471: 2003: Afdeling 5.1.5.1.1 en tabel 2 voor zowel kleur en luminantie.

Tech Data **10091**

Flexibel - met textielinlage - 30 meter rol

PVC	ID mm	OD mm	mm	bar	€
HVIS06-30	6.3	11.5	28	20	31.60
HVIS08-30	8	13.5	34	20	38.60
HVIS10-30	10	16	40	20	50.60
HVIS12-30	12.5	18.5	55	20	55.70

Flexibel - met textielinlage - 50 meter rol

PVC	ID mm	OD mm	mm	bar	€
HVIS06-50	6.3	11.5	28	20	54.30
HVIS08-50	8	13.5	34	20	66.50
HVIS10-50	10	16	40	20	86.90
HVIS12-50	12.5	18.5	55	20	95.85

Flexibel - met textielinlage - 100 meter rol

PVC	ID mm	OD mm	mm	bar	€
HVIS06-100	6.3	11.5	28	20	105.20
HVIS08-100	8	13.5	34	20	128.90
HVIS10-100	10	16	40	20	168.50
HVIS12-100	12.5	18.5	55	20	185.90

PVC slangen



WATER FLEX TRICOFLEX



Toepassingen:

- Tuinbouw
- Kassenbouw
- Beregening/besproeiing

Eigenschappen:

- Duurzame PVC buitenmantel
- Slijtvast
- Polyester textielinlage met hoge treksterkte

- Uitstekende knikbestendigheid
- Multi-laags structuur

Temperatuur:
-15°C tot +60°C

WATER FLEX waterslang

Tech Data
20215

Flexibel - met textielinlage - 25 meter rol

PVC	ID (mm)	OD (mm)	bar	€
GH12	12,5	17,5	11	34.45
GH19	19	25,5	7	67.15
GH25	25	32,5	6	100.80

Flexibel - met textielinlage - 50 meter rol

PVC	ID (mm)	OD (mm)	bar	€
GH12-50	12,5	17,5	11	68.75
GH19-50	19	25,5	7	134.40
GH25-50	25	32,5	6	201.60

Flexibel - met textielinlage - 100 meter rol

PVC	ID (mm)	OD (mm)	bar	€
GH12-100	12,5	17,5	11	137.65
GH19-100	19	25,5	7	268.80
GH25-100	25	32,5	6	403.05

Heavy duty 4-laags waterslang

Hoge kwaliteit 4-laagse agrarische slang met uitstekende flexibele en absorberende kwaliteiten.
Toepasbaar in land-/tuinbouw, industrie & huishoudelijke toepassingen

Temperatuur:
-10°C tot +80°C



Flexibel - 50 meter rol

PVC	ID (mm)	ID (inch)	OD (mm)	bar	€
HDAWH12	12,5	1/2"	17,5	9	112.45
HDAWH34	19	3/4"	25	8	176.85

Tricoflex® waterslang

Flexibel - met textielinlage - 25 meter rol

6750	ID (mm)	mm	bar	€
TRICO12	12,5	2,75	10	54.35
TRICO19	19	3,25	9,2	94.15
TRICO25	25	3,75	8	155.90

Flexibel - met textielinlage - 50 meter rol

6750	ID (mm)	mm	bar	€
TRICO12-50M	12,5	2,75	10	108.65
TRICO19-50M	19	3,25	9,2	219.25
TRICO25-50M	25	3,75	8	311.80

Flexibel - met textielinlage - 100 meter rol

6750	ID (mm)	mm	bar	€
TRICO12-100M	12,5	2,75	10	217.30
TRICO19-100	19	3,25	9,2	376.50
TRICO25-100	25	3,75	8	623.55

TURBOFLEX heavy duty waterslang

Temperatuur:
17°C tot +60°C



Flexibel - met textielinlage - 50 meter rol

PVC	ID (inch)	mm	€
19351208	1/2"	2,5	112.40
19351913	3/4"	3,1	195.60
19352517	1"	4	327.10

KELM™
pneumatiek

Hydrauliek

Snel-
koppelingen

Afsluiters

Roestvast
staal

Fittingen

Lucht-
conditionering

Gereedschap

Pneumatiek

Diversen

Malleabele
fittingen
& staal

Ringleiding-
systemen

Slangen

Compressoren

Hoge kwaliteit slangpilaren tegen aantrekkelijke prijzen!

In verschillende uitvoeringen leverbaar.

Messing slangpilaren zijn bruikbaar voor diverse toepassingen zoals brandstof, gas, olie, perslucht, hydrauliek en water.



BSPT volgens ISO 7.1, BS21, DIN-2999
BSPP volgens ISO 228 klasse A



Door de uitgebreide range is het niet mogelijk om exacte drukwaarden te definiëren, hieronder de geadviseerde maximale druk.

Maat:	Maximale druk:
1/8"	200 bar
1/4"	150 bar
3/8"	100 bar
1/2"	100 bar
3/4"	120 bar
1"	120 bar

Veiligheidsfactor: 3



Zie
pagina
738

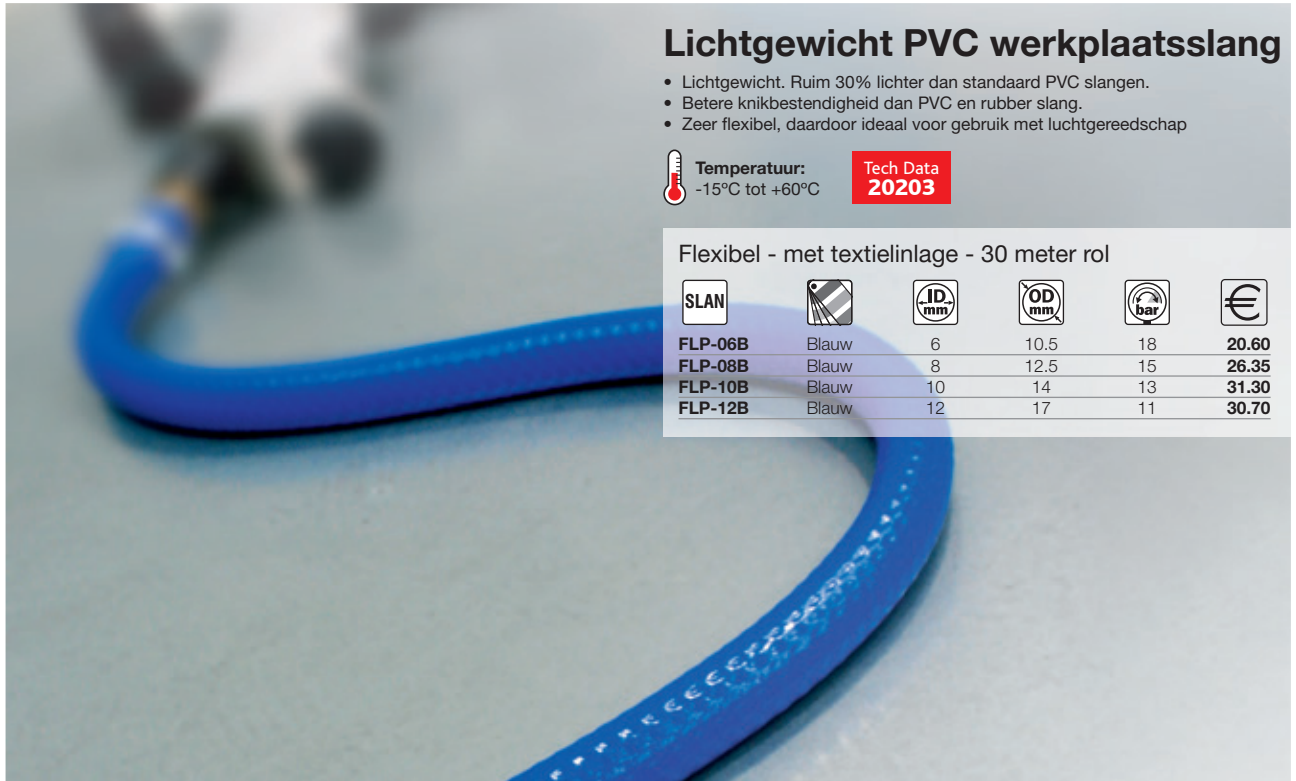

Lichtgewicht PVC werkplaatsslang

- Lichtgewicht. Ruim 30% lichter dan standaard PVC slangen.
- Betere knikbestendigheid dan PVC en rubber slang.
- Zeer flexibel, daardoor ideaal voor gebruik met luchtgereedschap

Temperatuur:
-15°C tot +60°C

Tech Data
20203

Flexibel - met textielinlage - 30 meter rol

SLAN					€
FLP-06B	Blauw	6	10.5	18	20.60
FLP-08B	Blauw	8	12.5	15	26.35
FLP-10B	Blauw	10	14	13	31.30
FLP-12B	Blauw	12	17	11	30.70

Rubber-Tech werkplaatsslang

Deze slang oogt en voelt als rubber, zonder de negatieve aspecten die daarmee in verband gebracht worden.

- Zeer slijtvast en knikvrij
- Geschikt voor gebruik met olie & benzine
- Uitstekende ozonbestendigheid, geschikt voor binnen en buiten



Temperatuur:
-20°C tot +60°C

Tech Data
1380

100 meter rol

SLAN					€
RH06X-100	1/4"	6.3	14	20	128.45
RH08X-100	5/16"	8	17	20	186.95
RH10X-100	3/8"	10	19	20	215.05
RH13X-100	1/2"	12.5	23	20	294.50
RH19X-100	3/4"	19	30	20	441.65
RH25X-100	1"	25	37	20	610.90



KELM™
pneumatiek

Hydrauliek

Snel-
koppelingen

Afsluiters

Roestvast
staal

Fittingen

Lucht-
conditioning

Gereedschap

Pneumatiek

Diversen

Malleabele
fittingen &
staal

Ringleiding-
systemen

Slangen

Compressoren

- **Voor drukknop veiligheidssnelkoppelingen conform ARB0/ISO 4414 zie pagina 257 en 262**

- **Met Euro, Orion & ISO 6150-C profiel**



Superior werkplaatsslang



Superieure slang van rubbermengsel, met alle goede eigenschappen van rubber, maar zonder de geassocieerde negatieve aspecten.

- **Sterke wapening:** hoogwaardige polyester inlage
- **Zeer flexibel:** uitstekende buigradius (anti-knik)
- **Duurzaam:** uitermate slijtvast en buitenmantel bestand tegen olie en brandstof
- **Siliconenvrij**
- **Veilig:** goed zichtbare groene streep tegen struikelgevaar
- **Ideaal voor buitengebruik:** uitstekende ozonbestendigheid
- **Gladde boring:** consistente binnen- en buitendiameters met een gladde boring voor een optimale flow

Tech Data **20738**



Werktemperatuur:
-20°C tot +60°C



Maximale werkdruk:
20 bar

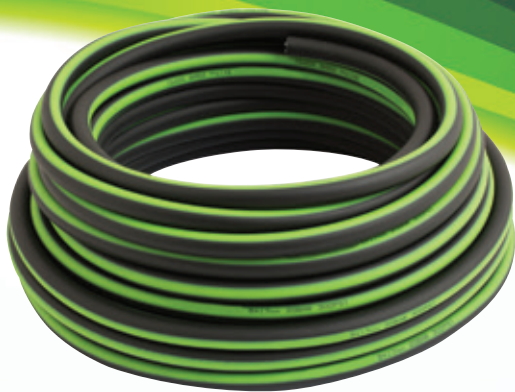

Deze slang is op aanvraag leverbaar in diverse lengtes

Zeer flexibel - met textielinlage - 30 meter rol

0410	ID	ID mm	OD mm	€
SRAH06X	1/4"	6.3	14	36.65
SRAH08X	5/16"	8	17	55.20
SRAH10X	3/8"	10	19	64.05
SRAH13X	1/2"	12.5	23	93.00
SRAH19X	3/4"	19	30	124.75
SRAH25X	1"	25	37	169.45

Zeer flexibel - met textielinlage - 100 meter rol

0410	ID	ID mm	OD mm	€
SRAH06X-100	1/4"	6.3	14	122.25
SRAH08X-100	5/16"	8	17	191.90
SRAH10X-100	3/8"	10	19	223.00
SRAH13X-100	1/2"	12.5	23	313.80
SRAH19X-100	3/4"	19	30	434.55
SRAH25X-100	1"	25	37	565.00

Werkplaatsslangen



Industriële rubber werkplaatsslang

Soepele, slijtvaste perslucht slang met synthetische inlage conform BS5118/1 (20 bar werkdruk) en volgens de fysieke eisen van BS ISO 2398 Type 3 Klasse A 1995.

Temperatuur:
65°C max.



Flexibel - met textielinlage - 100 meter rol

SLAN	ID	bar	ID mm	OD mm	L m		€
AMR100-14	1/4"	20	6	14	100	Zwart	224.75
AMR100-516	5/16"	20	8	16	100	Zwart	279.75
AMR100-38	3/8"	20	10	18	100	Zwart	333.15
AMR100-12	1/2"	20	13	22	100	Zwart	432.95
AMR100-34	3/4"	20	19	29	100	Zwart	640.60

POLIPO 10 BAR werkplaatsslang

Lichtgewicht slang, zeer flexibel, knikvrij en slijtvast. Uitstekende bestendigheid tegen olie, vet en UV. Blijft ook soepel bij lage temperaturen.

Toepassingen: Persluchtgereedschap, verfspuiten, pompen en blazen.
Materiaal: Speciaal kunststof met polyester inlage.

Temperatuur:
-5°C tot +60°C



Zeer flexibel - met textielinlage - 100 meter rol

SLAN	OD mm	ID mm	bar		L m	€
23211508	15	8	15	Zwart	100	276.30
23211510	15	10	14	Zwart	100	276.90

Polyurethaan (PU) slangen



RAGNO PU FOOD slang

Groene slijtvaste PU food slang verpakt in handige dozen. Lichtgewicht, sterk, slijtvast en zeer soepel (ook bij lage temperaturen).

Hoge bestendigheid tegen ozon, koolwaterstoffen, vetten, olie en minder agressieve chemicaliën.

Toepassing: Persluchtgereedschap, verfspuiten, pompen, blazen en voedingsmiddelen.

Gecertificeerd: Volgens D.M 21-3-73 en vervolg.

Materiaal: PU slang met een slijtvaste inlage van PU en thermoplastisch rubbermengsel.



Temperatuur:
-15°C tot +60°C

60 bar



Flexibel - food - met textielinlage - diverse rollengtes

SLAN	OD mm	ID mm	bar		L m	€
18121006	10	6	20	Groen	100	317.60
18121208	12	8	20	Groen	60	267.75
18121510	15	10	20	Groen	50	296.20
18121913	19	13	20	Groen	30	229.15
18122316	23	16	20	Groen	25	244.85

Flexi-Braid heavy duty PU slang

Een uitstekend alternatief voor rubber en plastic slangen. Zeer geschikt voor industrieel gebruik.

- Ongevoelig voor pulsdrukken.
- Verhard niet doordat geen weekmakers zijn toegevoegd.
- Lichtgewicht.
- Slijtvast en zeer sterk.
- Multifunctioneel voor binnen en buiten.
- Flexibel, ook bij lage temperaturen.

Temperatuur:
-20°C tot +80°C

Tech Data
20346

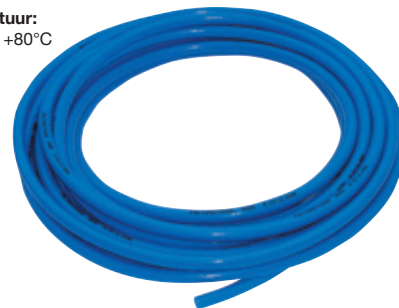

Flexibel - met textielinlage - 25 meter rol

SLAN	OD mm	ID mm	bar		L m	€
18251065	10	6,5	15	Blauw	25	48.15
18251208	12	8	15	Blauw	25	65.55
18251410	14,5	10	15	Blauw	25	75.90

KELM™
pneumatiek

Hydrauliek

Snel-
koppelingen

Atsluiters

Roestvast
staal

Fittingen

Lucht-
conditionering

Gereedschap

Pneumatiek

Diversen

Malleabele
fittingen
& staal

Ringleiding-
systemen

Slangen

Compressoren

Polyurethaan (PU) slangen

Tech Data **3131**

PU Ester slang

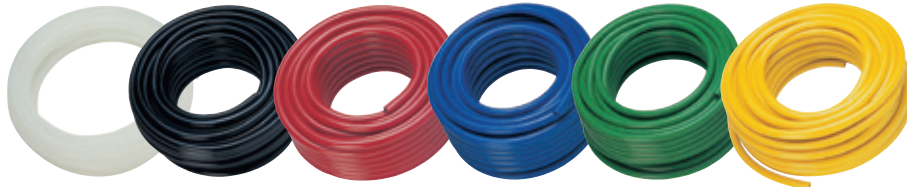

Werktemperatuur:
-20°C tot +55°C

Werkdruk:
7 tot 13 bar

Ester basis slang is niet geschikt voor gebruik met water of in omgevingen met hoge luchtvochtigheid.

- Ester basis Polyurethaan slang heeft hoogwaardige eigenschappen vergeleken met andere persluchtsslagen. Deze slang is extreem flexibel en heeft uitstekende buigeigenschappen. Zeer geschikt voor pneumatische controle- en automatisatiesystemen.
- Ook is deze slang bestand tegen vele chemicaliën, gassen en oliën en is zeer slijtvast (niet zuurbestendig). Ideaal voor gebruik met push-in koppelingen, knielkoppelingen en slangpilaren.

25 meter rollen PU slang worden geleverd in doos (m.u.v. 16mm slang)



Hoofdstuk 13 – Slangen

25 meter rol

PU	OD mm	ID mm	bar		€
PU03/020B	3	2	10	Blauw	10.75
PU04/025N	4	2.5	13	Zwart	12.50
PU04/025B	4	2.5	13	Blauw	12.50
PU04/025R	4	2.5	13	Rood	12.50
PU04/025Y	4	2.5	13	Geel	12.50
PU04/025G	4	2.5	13	Groen	12.50
PU04/025	4	2.5	13	Transparant	12.50
PU05/030N	5	3	11	Zwart	16.95
PU05/030B	5	3	11	Blauw	16.95
PU06/040N	6	4	11	Zwart	18.65
PU06/040B	6	4	11	Blauw	18.65
PU06/040R	6	4	11	Rood	18.65
PU06/040Y	6	4	11	Geel	18.65
PU06/040G	6	4	11	Groen	18.65
PU06/040	6	4	11	Transparant	18.65
PU08/055N	8	5.5	10	Zwart	29.65
PU08/055B	8	5.5	10	Blauw	29.65
PU08/055R	8	5.5	10	Rood	29.65
PU08/055Y	8	5.5	10	Geel	29.65
PU08/055G	8	5.5	10	Groen	29.65
PU08/055	8	5.5	10	Transparant	29.65
PU08/060N	8	6	8	Zwart	28.15
PU08/060B	8	6	8	Blauw	28.15
PU08/060R	8	6	8	Rood	28.15
PU08/060Y	8	6	8	Geel	28.15
PU08/060G	8	6	8	Groen	28.15
PU08/060	8	6	8	Transparant	28.15
PU10/065N	10	6.5	9	Zwart	57.05
PU10/065B	10	6.5	9	Blauw	57.05
PU10/065R	10	6.5	9	Rood	57.05
PU10/065Y	10	6.5	9	Geel	57.05
PU10/065G	10	6.5	9	Groen	57.05
PU10/065	10	6.5	9	Transparant	57.05
PU10/080N	10	8	8	Zwart	39.50
PU10/080B	10	8	8	Blauw	39.50
PU10/080R	10	8	8	Rood	39.50
PU10/080	10	8	8	Transparant	39.50
PU12/080N	12	8	8	Zwart	77.75
PU12/080B	12	8	8	Blauw	77.75
PU12/080R	12	8	8	Rood	77.75
PU12/080Y	12	8	8	Geel	77.75
PU12/080G	12	8	8	Groen	77.75
PU12/080	12	8	8	Transparant	77.75
PU16/110	16	11	7	Blauw	124.75

100 meter rol

PU	OD mm	ID mm	bar		€
PU04/025N-100	4	2.5	13	Zwart	49.70
PU04/025B-100	4	2.5	13	Blauw	49.70
PU04/025R-100	4	2.5	13	Rood	49.70
PU04/025Y-100	4	2.5	13	Geel	49.70
PU04/025G-100	4	2.5	13	Groen	49.70
PU04/025-100	4	2.5	13	Transparant	49.70
PU06/040N-100	6	4	11	Zwart	74.70
PU06/040B-100	6	4	11	Blauw	74.70
PU06/040R-100	6	4	11	Rood	74.70
PU06/040Y-100	6	4	11	Geel	74.70
PU06/040G-100	6	4	11	Groen	74.70
PU06/040-100	6	4	11	Transparant	74.70
PU08/055N-100	8	5.5	10	Zwart	118.85
PU08/055B-100	8	5.5	10	Blauw	118.85
PU08/055R-100	8	5.5	10	Rood	118.85
PU08/055Y-100	8	5.5	10	Geel	118.85
PU08/055G-100	8	5.5	10	Groen	118.85
PU08/055-100	8	5.5	10	Transparant	118.85
PU08/060N-100	8	6	8	Zwart	112.70
PU08/060B-100	8	6	8	Blauw	112.70
PU08/060R-100	8	6	8	Rood	112.70
PU08/060Y-100	8	6	8	Geel	112.70
PU08/060G-100	8	6	8	Groen	112.70
PU08/060-100	8	6	8	Transparant	112.70
PU10/065N-100	10	6.5	9	Zwart	228.15
PU10/065B-100	10	6.5	9	Blauw	228.15
PU10/065R-100	10	6.5	9	Rood	228.15
PU10/065Y-100	10	6.5	9	Geel	228.15
PU10/065G-100	10	6.5	9	Groen	228.15
PU10/065-100	10	6.5	9	Transparant	228.15
PU10/080N-100	10	8	8	Zwart	132.45
PU10/080B-100	10	8	8	Blauw	132.45
PU10/080R-100	10	8	8	Rood	132.45
PU10/080Y-100	10	8	8	Geel	132.45
PU10/080G-100	10	8	8	Groen	132.45
PU10/080-100	10	8	8	Transparant	132.45
PU12/080N-100	12	8	8	Zwart	310.90
PU12/080B-100	12	8	8	Blauw	310.90
PU12/080R-100	12	8	8	Rood	310.90
PU12/080G-100	12	8	8	Groen	310.90
PU12/080-100	12	8	8	Transparant	310.90

Polyurethaan (PU) slangen

Tech Data **3132**

PU Ether slang



Werktemperatuur:
-40°C tot +70°C



Vacuümgraad 28" Hg.

- Veiligheidsfactor 3 tot 1.

PU slang op ether-basis heeft een grotere bestendigheid tegen water en omgevingen met hoge luchtvochtigheid.

- PUET luchtslang is gemaakt van 95A shore durometer, ether-basis polyurethaan is een uitstekende keuze voor persluchtssystemen.
- Knikvrij, slijtvast en zeer flexibel.
- Bestand tegen vele chemicaliën, gassen en oliën (niet zuurbestendig).

25 meter rollen PU slang worden geleverd in doos

25 meter rol

PU	OD mm	ID mm	bar		€
PUET04/025N-25	4	2,5	11	Zwart	18.65
PUET04/025B-25	4	2,5	11	Blauw	18.65
PUET04/025-25	4	2,5	11	Transparant	18.65
PUET05/030N-25	5	3	12	Zwart	25.75
PUET05/030B-25	5	3	12	Blauw	25.75
PUET05/030-25	5	3	12	Transparant	25.75
PUET06/040N-25	6	4	10	Zwart	30.35
PUET06/040B-25	6	4	10	Blauw	30.35
PUET06/040-25	6	4	10	Transparant	30.35
PUET08/055N-25	8	5,5	8	Zwart	45.70
PUET08/055B-25	8	5,5	8	Blauw	45.70
PUET08/055-25	8	5,5	8	Transparant	45.70
PUET10/070N-25	10	7	8	Zwart	65.15
PUET10/070B-25	10	7	8	Blauw	65.15
PUET10/070-25	10	7	8	Transparant	65.15
PUET12/080N-25	12	8	9	Zwart	96.95
PUET12/080B-25	12	8	9	Blauw	96.95
PUET12/080-25	12	8	9	Transparant	96.95

100 meter rol

PU	OD mm	ID mm	bar		€
PUET04/025N-100	4	2,5	11	Zwart	74.60
PUET04/025B-100	4	2,5	11	Blauw	74.60
PUET04/025-100	4	2,5	11	Transparant	74.60
PUET06/040N-100	6	4	10	Zwart	121.30
PUET06/040B-100	6	4	10	Blauw	121.30
PUET06/040-100	6	4	10	Transparant	121.30
PUET08/055N-100	8	5,5	8	Zwart	182.45
PUET08/055B-100	8	5,5	8	Blauw	182.45
PUET08/055-100	8	5,5	8	Transparant	182.45
PUET10/070N-100	10	7	8	Zwart	260.55
PUET10/070B-100	10	7	8	Blauw	260.55
PUET10/070-100	10	7	8	Transparant	260.55
PUET12/080N-100	12	8	9	Zwart	387.95
PUET12/080B-100	12	8	9	Blauw	387.95
PUET12/080-100	12	8	9	Transparant	387.95

Hoofdstuk 13 – Slangen

KELM™ pneumatiek

Hydrauliek

Snelkoppelingen

Atsluiters

Roestvast staal

Fittingen

Luchtconditionering

Gereedschap

Pneumatiek

Diversen

Malleabele fittingen & staal

Ringleidingssystemen

Slangen

Compressoren

Voor



persluchtverzorging



...zie pagina 4

Polyamide (PA) slangen

Tech Data **3136**

PA Nylon 6 slang



Deze slang is niet geschikt voor gebruik met water of in omgevingen met hoge luchtvochtigheid.



30 meter rollen PA slang worden geleverd in doos (m.u.v. 15, 16, 18 & 22mm)

Werktemperatuur:
-10°C tot +80°C

Materiaal: Nylon 6
Andere kleuren en lengtes zijn op aanvraag leverbaar.
• UV-bestendig • Siliconenvrij • slijtvast
Zeer geschikt voor gebruik in pneumatische systemen
(Bij uitstek geschikt voor gebruik met push-in fittingen)

30 meter rol

5010	OD mm	ID. mm	bar		€
NTM04/030	4	3	21	Naturel	11.60
NTM04/025	4	2.5	28	Naturel	11.00
NTM04/025N	4	2.5	28	Zwart	11.00
NTM04/025B	4	2.5	28	Blauw	11.00
NTM04/025G	4	2.5	28	Groen	11.00
NTM04/025R	4	2.5	28	Rood	11.00
NTM04/025Y	4	2.5	28	Geel	11.00
NTM05/030	5	3	28	Naturel	16.00
NTM05/030N	5	3	28	Zwart	16.00
NTM05/030B	5	3	28	Blauw	16.00
NTM05/030G	5	3	28	Groen	16.00
NTM05/030R	5	3	28	Rood	16.00
NTM05/030Y	5	3	28	Geel	30.30
NTM05/033	5	3.3	21	Naturel	16.00
NTM06/040	6	4	24	Naturel	20.25
NTM06/040N	6	4	24	Zwart	20.30
NTM06/040B	6	4	24	Blauw	20.30
NTM06/040G	6	4	24	Groen	20.30
NTM06/040R	6	4	24	Rood	20.30
NTM06/040Y	6	4	24	Geel	20.30
NTM06/045	6	4.5	21	Naturel	23.85
NTM08/060	8	6	24	Naturel	29.10
NTM08/060N	8	6	24	Zwart	29.10
NTM08/060B	8	6	24	Blauw	29.10
NTM08/060G	8	6	24	Groen	29.10
NTM08/060R	8	6	24	Rood	29.10
NTM08/060Y	8	6	24	Geel	29.10
NTM08/055	8	5.5	24	Naturel	32.95

30 meter rol

5010	OD mm	ID. mm	bar		€
NTM08/055N	8	5.5	24	Zwart	32.95
NTM10/070	10	7	21	Naturel	48.40
NTM10/070N	10	7	21	Zwart	48.40
NTM10/070B	10	7	21	Blauw	48.40
NTM10/070G	10	7	21	Groen	48.40
NTM10/070R	10	7	21	Rood	48.40
NTM10/070Y	10	7	21	Geel	48.40
NTM10/080	10	8	15	Naturel	36.30
NTM10/080N	10	8	15	Zwart	36.30
NTM10/080B	10	8	15	Blauw	36.30
NTM10/080G	10	8	15	Groen	36.30
NTM10/080R	10	8	15	Rood	36.30
NTM10/080Y	10	8	15	Geel	36.30
NTM12/090	12	9	17	Naturel	59.10
NTM12/090N	12	9	17	Zwart	59.10
NTM12/090B	12	9	17	Blauw	59.10
NTM12/090G	12	9	17	Groen	59.10
NTM12/090R	12	9	17	Rood	59.10
NTM12/090Y	12	9	17	Geel	59.10
NTM12/100	12	10	14	Naturel	41.85
NTM12/100N	12	10	14	Zwart	41.85
NTM12/100R	12	10	14	Rood	41.85
NTM14/110	14	11	17	Naturel	71.75
NTM14/110N	14	11	17	Zwart	71.75
NTM15/120	15	12	14	Naturel	78.90
NTM16/130	16	13	14	Naturel	83.05
NTM18/140	18	14	14	Naturel	119.85
NTM22/170	22	17	12	Naturel	213.20

100 meter rol

5010	OD mm	ID. mm	bar		€
NTM04/025-100	4	2.5	27	Naturel	27.15
NTM05/030-100	5	3	27	Naturel	42.65
NTM06/040-100	6	4	24	Naturel	60.85
NTM06/040R-100	6	4	24	Zwart	60.85
NTM06/040B-100	6	4	24	Blauw	60.85
NTM06/040G-100	6	4	24	Groen	60.85
NTM06/040R-100	6	4	24	Rood	60.85
NTM06/040Y-100	6	4	24	Geel	60.85
NTM08/060-100	8	6	24	Naturel	87.20
NTM08/060N-100	8	6	24	Zwart	87.20
NTM08/060B-100	8	6	24	Blauw	87.20
NTM10/080-100	10	8	15	Naturel	109.15
NTM10/080N-100	10	8	15	Zwart	109.15
NTM10/080B-100	10	8	15	Blauw	109.15

500 meter rol

5010	OD mm	ID. mm	bar		€
NTM06/040-500	6	4	24	Naturel	304.20
NTM06/040-500B	6	4	24	Blauw	304.20
NTM08/060-500	8	6	24	Naturel	436.15

• **tst** (drukknop) snelkoppelingen & insteeknippels vanaf pagina 257



Polyamide (PA) slangen

Tech Data 1386

PA Nylon 12 slang - DIN73378

Temperatuur:
-40°C tot +80°C

Olie- en benzinebestendig (niet zuurbestendig).

Toepassing: pneumatische systemen, brandstofleidingen, smeersystemen en ook geschikt voor voedingsindustrie.

Vervaardigd uit superieure kwaliteit grondstoffen. De eigenschappen van deze slang zorgen ervoor dat de slang zeer geschikt is voor gebruik in een vochtige atmosfeer.

Bij uitstek geschikt voor gebruik met push-in fittingen.

Iedere temperatuursverhoging heeft een negatief effect op de drukkbestendigheid.

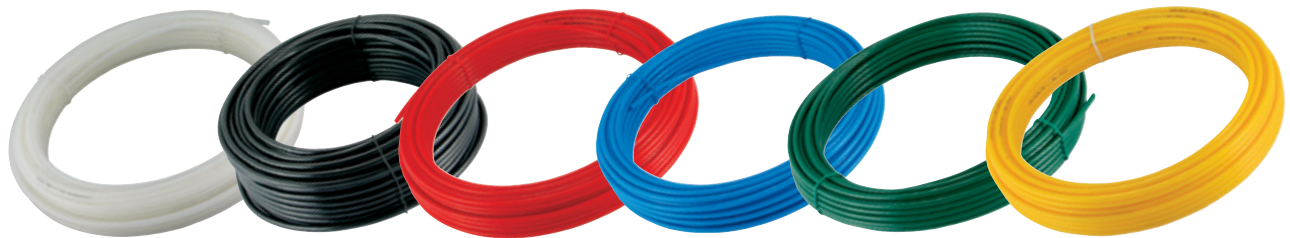

30 meter rol

5010	OD mm	ID mm		bar	€
BNTM03/015	3	1.5	Naturel	13	18.55
BNTM04/2	4	2	Naturel	24	32.95
BNTM04/025	4	2.5	Naturel	27	19.10
BNTM04/025N	4	2.5	Zwart	27	19.10
BNTM04/025B	4	2.5	Blauw	27	19.10
BNTM04/025G	4	2.5	Groen	27	19.10
BNTM04/025R	4	2.5	Rood	27	19.10
BNTM05/030	5	3	Naturel	27	29.45
BNTM05/030N	5	3	Zwart	27	29.45
BNTM05/030B	5	3	Blauw	27	29.45
BNTM06/030	6	3	Naturel	24	52.15
BNTM06/040	6	4	Naturel	24	32.50
BNTM06/040N	6	4	Zwart	24	32.50
BNTM06/040B	6	4	Blauw	24	32.50
BNTM06/040G	6	4	Groen	24	32.50
BNTM06/040R	6	4	Rood	24	32.50
BNTM06/040Y	6	4	Geel	24	32.50
BNTM08/060	8	6	Naturel	24	44.25
BNTM08/060N	8	6	Zwart	24	44.25
BNTM08/060B	8	6	Blauw	24	44.25
BNTM08/060R	8	6	Rood	24	44.25
BNTM08/060G	8	6	Groen	24	44.25
BNTM08/060Y	8	6	Geel	24	44.25
BNTM10/070	10	7	Naturel	20	79.85
BNTM10/070N	10	7	Zwart	20	79.85
BNTM10/070B	10	7	Blauw	20	79.85
BNTM10/070R	10	7	Rood	20	79.85
BNTM10/080	10	8	Naturel	15	60.85
BNTM10/080N	10	8	Zwart	15	60.85
BNTM10/080B	10	8	Blauw	15	60.85
BNTM10/080R	10	8	Rood	15	60.85
BNTM12/090	12	9	Naturel	17	96.40
BNTM12/090N	12	9	Zwart	17	96.40
BNTM12/090B	12	9	Blauw	17	96.40
BNTM12/090R	12	9	Rood	17	96.40
BNTM12/100	12	10	Naturel	13	67.75
BNTM12/100N	12	10	Zwart	13	67.75
BNTM14/110	14	11	Naturel	17	120.60
BNTM14/110N	14	11	Zwart	17	120.60
BNTM16/130	16	13	Naturel	13	135.40

100 meter rol

5010	OD mm	ID mm		bar	€
BNTM04/025-100	4	2.5	Naturel	27	63.60
BNTM05/030-100	5	3	Naturel	27	98.25
BNTM06/040-100	6	4	Naturel	24	108.50
BNTM06/040N-100	6	4	Zwart	24	108.50
BNTM06/040B-100	6	4	Blauw	24	108.50
BNTM06/040G-100	6	4	Groen	24	108.50
BNTM06/040R-100	6	4	Rood	24	108.50
BNTM06/040Y-100	6	4	Geel	24	108.50
BNTM08/060-100	8	6	Naturel	24	147.60
BNTM08/060N-100	8	6	Zwart	24	147.60
BNTM08/060B-100	8	6	Blauw	24	147.60
BNTM08/060G-100	8	6	Groen	24	147.60
BNTM08/060R-100	8	6	Rood	24	147.60
BNTM08/060Y-100	8	6	Geel	24	147.60
BNTM10/080-100	10	8	Naturel	15	202.70
BNTM10/080N-100	10	8	Zwart	15	202.70
BNTM10/080B-100	10	8	Blauw	15	202.70
BNTM10/080R-100	10	8	Rood	15	202.70

500 meter rol op haspel

5010	OD mm	ID mm		bar	€
BNTM06/040-500	6	4	Naturel	24	542.95
BNTM06/040B-500	6	4	Blauw	24	542.95
BNTM08/060-500	8	6	Naturel	24	738.10
BNTM08/060B-500	8	6	Blauw	24	738.10

KELM™
pneumatiek

Hydrauliek

Snel-
koppelingen

Alsluiters

Roestvast
staal

Fittingen

Lucht-
conditionering

Gereedschap

Pneumatiek

Diversen

Malleabele
fittingen
& staal

Ringleiding-
systemen

Slangen

Compressoren

Polyamide (PA) slangen



PA Nylon 12 slang - DIN73378



- Olie- en benzinebestendig. Niet zuurbestendig.
- Gecalibreerd volgens CETOP.
- Op aanvraag leverbaar:

Andere maten, kleuren, lengtes en slangen op haspels (minimale afname van toepassing).

Temperatuur:
-40°C tot +80°C



25 meter rol

PAEF	OD mm	ID mm	bar	mm	L m	€
16100604	6	4	27	Naturel	25	25.80
16110604	6	4	27	Zwart	25	27.90
16140604	6	4	27	Blauw	25	27.90
16100806	8	6	19	Naturel	25	36.05
16110806	8	6	19	Zwart	25	39.45
16140806	8	6	19	Blauw	25	39.45
16101008	10	8	15	Naturel	25	54.25
16111008	10	8	15	Zwart	25	57.50
16141008	10	8	15	Blauw	25	57.50

100 meter rol

PAEF	OD mm	ID mm	bar	mm	L m	€
16200604	6	4	27	Naturel	100	101.15
16210604	6	4	27	Zwart	100	109.45
16240604	6	4	27	Blauw	100	109.45
16200806	8	6	19	Naturel	100	141.45
16210806	8	6	19	Zwart	100	154.80
16240806	8	6	19	Blauw	100	154.80
16201008	10	8	15	Naturel	100	212.85
16211008	10	8	15	Zwart	100	225.55
16241008	10	8	15	Blauw	100	225.55

Nylon slang - super flexibel

Super flexibele Nylon slang heeft een superieure flexibiliteit ten opzichte van bestaande materialen. De slang blijft flexibel, zelfs bij blootstelling aan zeer lage temperaturen en heeft een zeer hoge slagvastheid. De combinatie van deze eigenschappen met de voordelen van een hoge slijtvastheid en duurzaamheid voor olie en benzine, zorgt ervoor dat deze slang toepasbaar is voor vele toepassingen, o.a.: instrumentatie, brandstof- en olieleidingen, spuitslang voor verf en oplosmiddel.

Temperatuur:
-20°C tot +100°C

Tech Data
594



30 meter rol

PAEF	OD mm	ID mm	mm	mm	€
SFN04/025	4	2.5	25	Naturel	24.30
SFN04/025N	4	2.5	25	Zwart	47.60
SFN04/025B	4	2.5	25	Blauw	24.30
SFN04/025G	4	2.5	25	Groen	24.30
SFN04/025R	4	2.5	25	Rood	24.30
SFN04/025Y	4	2.5	25	Geel	24.30
SFN05/033	5	3	30	Naturel	62.40
SFN05/033N	5	3	30	Zwart	62.40
SFN06/040	6	4	35	Naturel	44.05
SFN06/040N	6	4	35	Zwart	87.55
SFN06/040B	6	4	35	Blauw	44.05
SFN06/040G	6	4	35	Groen	44.05
SFN06/040R	6	4	35	Rood	44.05
SFN08/055	8	5.5	45	Naturel	130.55
SFN08/055N	8	5.5	45	Zwart	130.55
SFN08/060	8	6	45	Naturel	59.95
SFN08/060N	8	6	45	Zwart	59.95
SFN08/060B	8	6	45	Blauw	59.95
SFN08/060G	8	6	45	Groen	59.95
SFN08/060R	8	6	45	Rood	59.95
SFN08/060Y	8	6	45	Geel	59.95
SFN10/070	10	7	60	Naturel	107.80
SFN10/070N	10	7	60	Zwart	204.80
SFN10/080	10	8	55	Naturel	82.40
SFN10/080N	10	8	55	Zwart	82.40
SFN10/080B	10	8	55	Blauw	82.40
SFN10/080G	10	8	55	Groen	91.55
SFN10/080R	10	8	55	Rood	91.55
SFN12/085	12	9	70	Naturel	290.10
SFN12/085N	12	9	70	Zwart	290.10
SFN12/085B	12	9	70	Blauw	134.85
SFN12/085G	12	9	70	Groen	149.85
SFN12/085R	12	9	70	Rood	134.85
SFN12/085Y	12	9	70	Geel	149.85
SFN12/100	12	10	65	Naturel	95.50

Hoofdstuk 13 - Slangen

KELM™
pneumatiek

Hydrauliek

Snel-
koppelingen

Afsluiters

Roestvast
staal

Fittingen

Lucht-
conditionering

Gereedschap

Pneumatiek

Diversen

Malleabele
fittingen
& staal

Ringleiding-
systemen

Slangen

Compressoren

• Voor drukknop veiligheidssnelkoppelingen conform ARB0/ISO 4414 zie pagina 257 en 262

• Met Euro, Orion & ISO 6150-C profiel

tst®



Polyethyleen (PE) slangen



LDPE slang



- Zuurbestendig, niet geschikt voor olie, vet en benzine.
- Zeer soepel
- Voedingskwaliteit LDPE
- Op aanvraag leverbaar: Andere maten, kleuren, lengtes en slangen op haspels (minimale afname van toepassing).

Temperatuur:
-40°C tot +120°C



100 meter rol

PE	OD mm	ID mm	bar		€
15200604	6	4	20	Naturel	49.00
15210604	6	4	20	Zwart	51.65
15240604	6	4	20	Blauw	51.65
15250604	6	4	20	Geel	51.65
15200806	8	6	10	Naturel	67.20
15210806	8	6	10	Zwart	70.45
15240806	8	6	10	Blauw	70.45
15250806	8	6	10	Geel	70.45
15230806	8	6	10	Rood	70.45
15201008	10	8	8	Naturel	76.25
15211008	10	8	8	Zwart	81.55
15241008	10	8	8	Blauw	81.55
15201007	10	7	13	Naturel	120.15
15211007	10	7	13	Zwart	126.35
15241007	10	7	13	Blauw	126.35
15201209	12	9	13	Naturel	142.35
15211209	12	9	13	Zwart	149.30
15241209	12	9	13	Blauw	149.30
15201512	15	12	8	Naturel	177.75
15241512	15	12	8	Blauw	186.60

HDPE slang

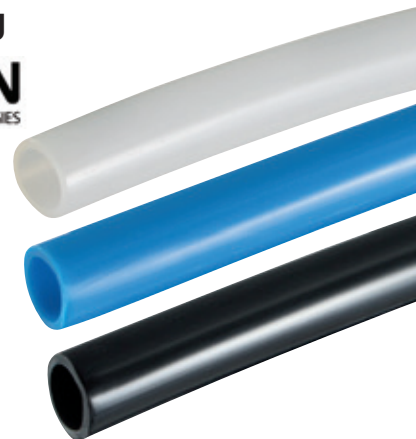

°C	bar
PN16	
20°C	16
30°C	10
40°C	6,5
45°C	5

Polyethyleen slang met zeer hoge moleculaire dichtheid. Lichtgewicht en slagvast. Door de hoge treksterkte en lage vochtopname een uitstekende slang voor veeleisende industriële toepassingen.

100 meter rol

PE	OD mm	ID mm	bar		€
14020046101	6	4	16	Wit	53.45
14020048101	8	6	16	Wit	61.55
14020046102	6	4	16	Zwart	53.45
14020048102	8	6	16	Zwart	61.55
14020046108	6	4	16	Blauw	53.45
14020048108	8	6	16	Blauw	61.55

- KELM™ pneumatiek
- Hydrauliek
- Snelkoppelingen
- Atsluiters
- Roestvast staal
- Fittingen
- Luchtconditionering
- Gereedschap
- Pneumatiek
- Diversen
- Malleabele fittingen & staal
- Ringleidingssystemen
- Slangen
- Compressoren

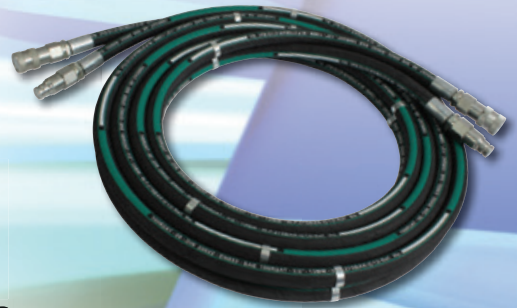

Vitassem levert een uitgebreid programma hydraulische en industriële slangassemblages.

Laat uw slangen volledig samenstellen **volgens uw specificaties.**

Hieronder valt het **ontwerp**, de **fabricage** en **uitgebreide testmogelijkheden** van slangen. Variërend van een kleine boring hydrauliekslang tot grote diameters industriële slang.

- **Nieuwe 6" persmachine voor slangen**

Deze persmachine heeft de mogelijkheid om slangen te persen met een boring tot 6". Deze investering draagt bij aan de professionalisering van de Vitassem werkplaats. Er zijn nu drie productielijnen beschikbaar om aan de groeiende vraag te voldoen.

Fabricage vindt plaats in een ISO 9001:2008 gecertificeerde werkomgeving. Er worden strenge normeringen gehandhaafd bij het testen van uw slang, dit zorgt voor optimale kwaliteitscontrole. Er wordt gebruikt gemaakt van de volgende testsystemen:

- **Hydrostatische slangentest: geschikt voor testen tot 1500 bar**
- **Stikstof slangentest: voor testen tot 30 bar**

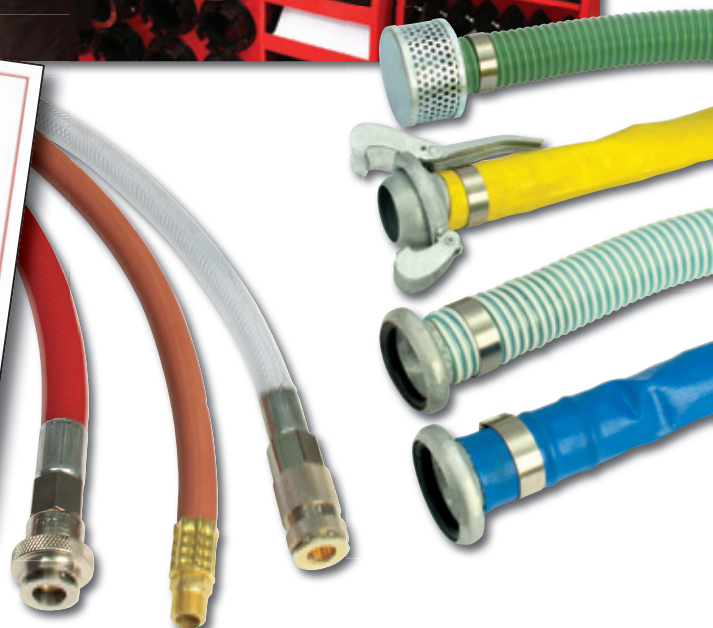

Industriële slangen

Layflat slang

Toepassing: Geschikt voor watertoevoer en -irrigatie. Ook voor algemeen gebruik in industrie en bouw.

Drukwaarde: Opgegeven waarden zijn gebaseerd op kortstondige barstdruk van de slang bij 20 °C, veiligheidsfactor 3:1.

Opmerking: Iedere temperatuurverhoging boven 20°C heeft een negatief effect op de drukbestendigheid.

Chemische weerstand: Bestand tegen olie en vet.

Deze slangen zijn niet geschikt voor benzine, gas, alcohol, xyleen, toluen of aromatische oplosmiddelen.

Temperatuur:
-15°C tot +55°C

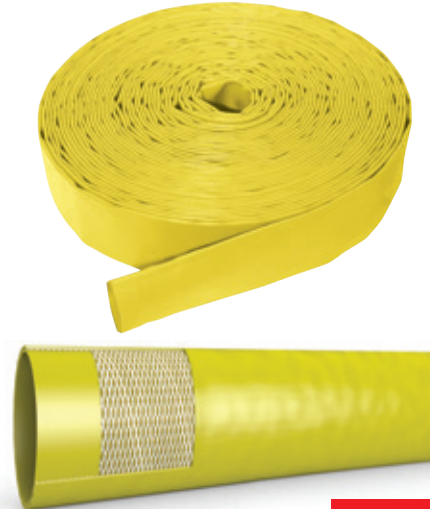
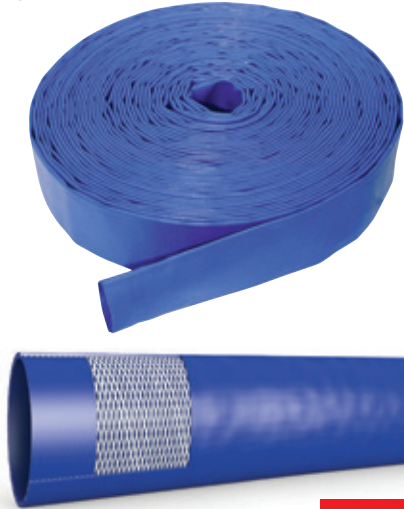

Blauw - 10 meter rol

Tech Data
20208

5998	ID	ID mm	bar	€
LFH114-10	1.1/4"	32	4.5	15.05
LFH112-10	1.1/2"	38	4.5	16.20
LFH2-10	2"	51	4.5	19.30
LFH212-10	2.1/2"	64	4.5	23.20
LFH3-10	3"	76	4.5	26.55
LFH4-10	4"	102	4.5	38.20
LFH6-10	6"	152	4.5	75.20
LFH8-10	8"	200	4.5	116.00

Blauw - 100 meter rol

Tech Data
20208

5998	ID	ID mm	bar	€
LFH1-100	1"	25	4.5	133.55
LFH114-100	1.1/4"	32	4.5	150.60
LFH112-100	1.1/2"	38	4.5	162.35
LFH2-100	2"	51	4.5	193.80
LFH212-100	2.1/2"	64	4.5	231.90
LFH3-100	3"	76	4.5	266.50
LFH4-100	4"	102	4.5	434.50
LFH6-100	6"	150	4.5	752.25
LFH8-100	8"	200	4.5	1316.45

Geel - 100 meter rol

Tech Data
20212

5998	ID	ID mm	bar	€
YLH-1	1"	25	6	140.25
YLH-114	1.1/4"	32	6	158.05
YLH-112	1.1/2"	38	6	170.50
YLH-2	2"	51	6	203.45
YLH-3	3"	76	6	279.85
YLH-4	4"	102	6	456.25
YLH-6	6"	152	6	790.00

Maximale werkdruk:
4,5 bar

Tech Data
20209

Slangkoppeling - male

5998	To Suit Hose I.D.	€
LMC-1	1"	2.20
LMC-114	1.1/4"	2.45
LMC-112	1.1/2"	2.45
LMC-2	2"	3.00
LMC-212	2.1/2"	3.05
LMC-3	3"	4.15
LMC-4	4"	5.90
LMC-5	5"	14.80

Slangkoppeling - female

5998	To Suit Hose I.D.	€
LFC-1	1"	2.10
LFC-114	1.1/4"	2.45
LFC-112	1.1/2"	2.45
LFC-2	2"	3.00
LFC-212	2.1/2"	3.05
LFC-3	3"	4.15
LFC-4	4"	5.90

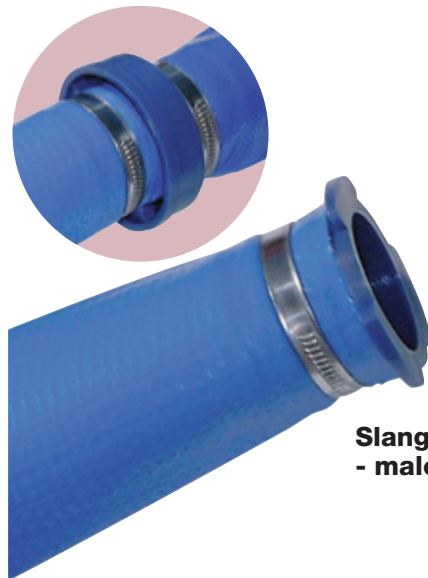

Slangkoppeling - female

Slangkoppeling - male

Let op, er zijn 2 koppelingen nodig om een koppelingsset te maken.

KELM™
pneumatiek

Hydrauliek

Snelkoppelingen

Atsluiters

Roestvast
staal

Fittingen

Lucht-
conditionering

Gereedschap

Pneumatiek

Diversen

Malleabele
fittingen
& staal

Ringleiding-
systemen

Slangen

Compressoren

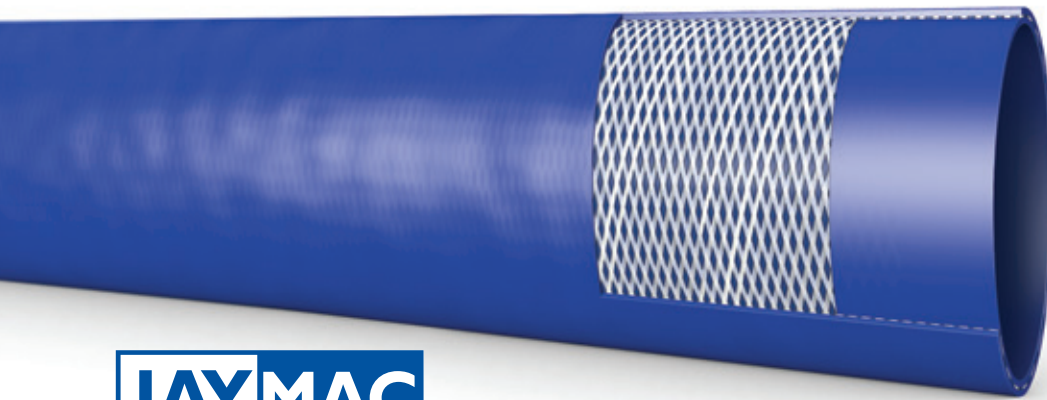

JAYMAC

Industrial Hose & Accessories

Hogedruk Layflat slang

Tech Data 20210

Toepassing:

Transport en afvoer van vloeistoffen onder druk.
Bijzonder geschikt voor irrigatie en watervoorziening in de algemene industrie, alsmede civiele-, land- en scheepsbouw.

Drukwaarde:

Opgegeven waarden zijn gebaseerd op kortstondige barstdruk van de slang bij 20°C, veiligheidsfactor 3:1.

Opmerking: ledere temperatuurverhoging boven 20°C heeft een negatief effect op de drukbestendigheid.

Drukwaarden zijn gebaseerd op de algemene pompdruk.

Chemische weerstand:

Deze slangen zijn niet geschikt voor benzine, gas, alcohol, xyleen, toluen of aromatische oplosmiddelen.

Blauw - 100 meter rol

5998	ID	ID (mm)	bar	€
HPLFH1-100	1"	25	10	172.90
HPLFH114-100	1.1/4"	32	10	219.40
HPLFH112-100	1.1/2"	38	10	277.55
HPLFH2-100	2"	51	10	371.05
HPLFH212-100	2.1/2"	64	10	523.95
HPLFH3-100	3"	76	10	635.75
HPLFH4-100	4"	102	10	903.40

Blauw - 10 meter rol

5998	ID	ID (mm)	bar	€
HPLFH1-10	1"	25	10	17.55
HPLFH114-10	1.1/4"	32	10	22.25
HPLFH112-10	1.1/2"	38	10	28.15
HPLFH2-10	2"	51	10	37.65
HPLFH212-10	2.1/2"	64	10	53.15
HPLFH3-10	3"	76	10	64.15
HPLFH4-10	4"	102	10	91.65



Temperatuur:
-5°C tot +65°C



Maximale werkdruk:
10 bar

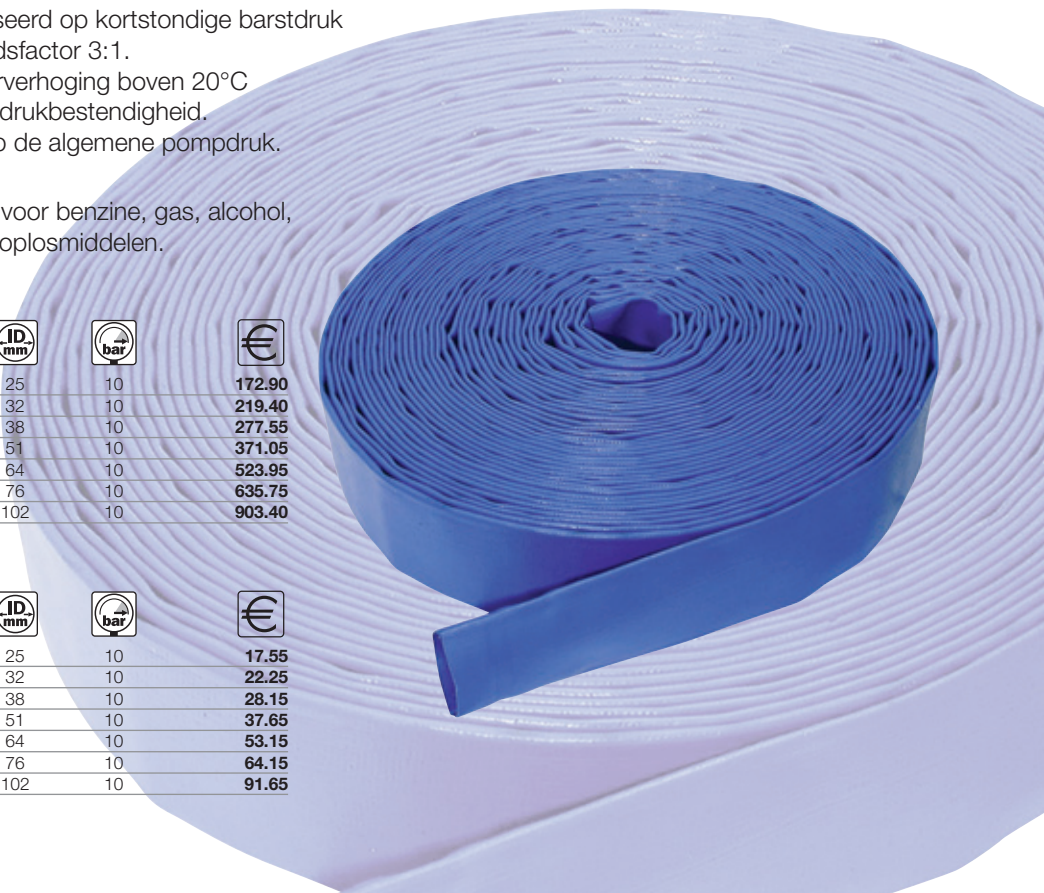

Tech Data 20211

MDS zuigslang

Koude buigradius: -45 °C

Vacuüm: 680mm Hg = 90% bij 20 °C

Ca. 15 % lichter dan vergelijkbare heavy duty zuigslangen.

Toepassing: Algemeen pomp- en zuigtoepassingen in landbouw, industrie en bouw. Transport van water, slib, mest, chemicaliën en overige afvalstoffen.

Drukwaarde: Opgegeven waarden zijn gebaseerd op kortstondige barstdruk van de slang bij 20 °C, veiligheidsfactor 3:1.

Opmerking: Iedere temperatuurverhoging boven 20 °C heeft een negatief effect op de drukbestendigheid.

Chemische weerstand: Bestand tegen de meeste oxiderende en reducerende stoffen en verdunde zuren en logen.

Olijfgroen - 10 meter rol

5998	-ID-	mm	bar	mm	€
MDS1-10	1"	3.8	7	125	29.50
MDS114-10	1.1/4"	4	7	160	36.20
MDS112-10	1.1/2"	4.4	6	190	52.95
MDS2-10	2"	4.8	5	250	73.65
MDS212-10	2.1/2"	5.2	4.5	315	98.60
MDS3-10	3"	5.2	5	300	118.55
MDS312-10	3.1/2"	5.5	4	375	147.35
MDS4-10	4"	6.3	4	400	199.00
MDS6-10	6"	7.5	3	800	381.00

Olijfgroen - 30 meter rol

5998	-ID-	mm	bar	mm	€
MDS1-30	1"	3.8	7	125	88.50
MDS114-30	1.1/4"	4	7	160	108.40
MDS112-30	1.1/2"	4.4	6	190	158.75
MDS2-30	2"	4.8	5	250	220.95
MDS212-30	2.1/2"	5.2	4.5	315	294.65
MDS3-30	3"	5.2	5	300	355.60
MDS312-30	3.1/2"	5.5	4	375	441.90
MDS4-30	4"	6.3	4	400	596.85
MDS6-30	6"	7.5	3	800	1143.00

Temperatuur:
-5°C tot +65°C



Hoofdstuk 13 – Slangen

Tech Data 20213

WDH waterslang

Koude buigradius: -45 °C

Vacuüm: 570 mm Hg = 75% bij 20 °C

Toepassing: Levering en zuiging van water, mest, chemicaliën, overige afvalstoffen en riolering. Bijzonder geschikt voor tuinbouw en maritieme industrie.

Drukwaarde: Opgegeven waarden zijn gebaseerd op kortstondige barstdruk van de slang bij 20 °C, veiligheidsfactor 3:1.

Opmerking: Iedere temperatuurverhoging boven 20 °C heeft een negatief effect op de drukbestendigheid.

Chemische weerstand: Bestand tegen de meeste oxiderende en reducerende stoffen en verdunde zuren en logen.

Transparant groen - 10 meter rol

5998	-ID-	mm	bar	mm	€
WDH34-10	3/4"	2.4	8	110	19.80
WDH1-10	1"	2.4	8	140	26.40
WDH114-10	1.1/4"	2.6	8	180	32.40
WDH112-10	1.1/2"	3	8	210	47.55
WDH2-10	2"	3.6	7	270	66.00
WDH212-10	2.1/2"	3.7	6	350	80.10
WDH3-10	3"	4.1	5	500	107.60
WDH4-10	4"	5.6	5	330	174.85

Transparant groen - 30 meter rol

5998	-ID-	mm	bar	mm	€
WDH34-30	3/4"	2.4	8	110	59.25
WDH1-30	1"	2.4	8	140	79.45
WDH114-30	1.1/4"	2.6	8	180	97.40
WDH112-30	1.1/2"	3	8	210	142.65
WDH2-30	2"	3.6	7	270	200.10
WDH212-30	2.1/2"	3.7	6	350	264.80
WDH3-30	3"	4.1	5	500	322.50
WDH4-30	4"	5.6	5	330	524.45

Temperatuur:
-15°C tot +65°C

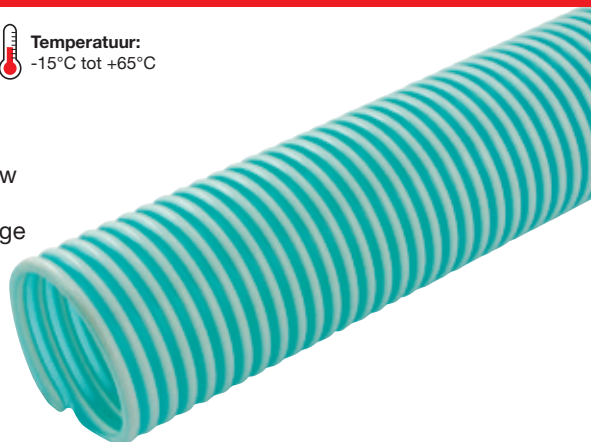

KELM™
pneumatiek

Hydrauliek

Snel-
koppelingen

Atsluiters

Roestvast
staal

Fittingen

Lucht-
conditionering

Gereedschap

Pneumatiek

Diversen

Malleabele
fittingen
& staal

Ringleiding-
systemen

Slangen

Compressoren

FX heldere zuigslang

Heldere PVC slang met staalraadpiraal.

Koude buigradius: -45 °C

Vacuüm: 711 mm Hg = 94% bij 20 °C

Toepassing: Geschikt voor het zuiging en afvoer van water, mest, chemicaliën, afvalwater, korrels en ander afvalmateriaal. Gebruikte grondstoffen zijn conform de FDA-eisen voor gebruik met voedingsmiddelen.

Drukwaarde: Opgegeven waarden zijn gebaseerd op kortstondige barstdruk van de slang bij 20 °C, veiligheidsfactor 3:1.

Opmerking: Iedere temperatuurverhoging boven 20 °C heeft een negatief effect op de drukbestendigheid.

Chemische weerstand: Bestand tegen de meeste oxiderende en reducerende stoffen en verdunde zuren en logen.



Temperatuur:
-5°C tot +65°C



- KELM™ pneumatiek
- Hydrauliek
- Snelkoppelingen
- Afsluiters
- Roestvast staal
- Fittingen
- Luchtconditionering
- Gereedschap
- Pneumatiek
- Diversen
- Malleabele fittingen & staal
- Ringleidingssystemen
- Slangen
- Compressoren

Helder - 10 meter rol

	5998	-ID-	mm	bar	mm	€
FX075-10		3/4"	3,4	6	80	30.05
FX100-10		1"	4	6	100	34.55
FX125-10		1.1/4"	4,8	5	130	50.90
FX150-10		1.1/2"	5,5	5	155	58.75
FX200-10		2"	7	5	200	86.30
FX250-10		2.1/2"	7	4	260	154.70
FX300-10		3"	8	4	320	170.05

Helder - 30 meter rol

	5998	-ID-	mm	bar	mm	€
FX050-30		1/2"	3	6	50	48.60
FX075-30		3/4"	3,4	6	80	89.95
FX100-30		1"	4	5	100	103.70
FX150-30		1.1/2"	5,5	5	155	176.10
FX200-30		2"	7	5	200	265.20
FX300-30		3"	8	4	320	510.10

Superflexibele medium duty zuigslang

Superflexibele medium duty zuigslang is een robuuste slang voor algemene doeleinden. Goede plet- en weerbestendigheid, en zeer eenvoudig in gebruik als gevolg van de extra flexibiliteit. Wit ingekapseld nylon helixspiraal in superflexibel groen pvc.

Vacuüm: 680mm Hg = 90% bij 20 °C

Toepassing: Geschikt voor algemene pomp- en zuigtoepassingen in de landbouw, bouw en waterbehandelingsindustrie. Vervoer van water, slib, mest en overig afval. Kan ook worden gebruikt om te kleine deeltjes te vervoeren zoals veevoer en kunststof korrels.

Drukwaarde: Opgegeven waarden zijn gebaseerd op kortstondige barstdruk van de slang bij 20 °C, veiligheidsfactor 3:1.

Opmerking: Iedere temperatuurverhoging boven 20 °C heeft een negatief effect op de drukbestendigheid.

Chemische weerstand: Bestand tegen de meeste oxiderende en reducerende stoffen en verdunde zuren en logen.



Temperatuur:
-15°C tot +60°C

Donker olijfgroen - 10 meter rol

5998	ID	mm	bar	mm	€
SFMS34-10	3/4"	3.3	8	100	22.30
SFMS1-10	1"	3.5	8	110	24.75
SFMS114-10	1.1/4"	3.7	7	135	36.30
SFMS112-10	1.1/2"	4	7	150	53.10
SFMS2-10	2"	4.3	6.5	200	74.40
SFMS212-10	2.1/2"	5.2	7	250	97.15
SFMS3-10	3"	5	4.5	300	119.75
SFMS312-10	3.1/2"	5.5	5	350	144.90
SFMS4-10	4"	6	5	400	211.30
SFMS6-10	6"	7.5	2	600	394.45

Donker olijfgroen - 30 meter rol

5998	ID	mm	bar	mm	€
SFMS34-30	3/4"	3.3	8	100	66.90
SFMS1-30	1"	3.5	8	110	89.70
SFMS114-30	1.1/4"	3.7	7	135	115.20
SFMS112-30	1.1/2"	4	7	150	168.55
SFMS2-30	2"	4.3	6.5	200	223.90
SFMS212-30	2.1/2"	5.2	7	250	270.35
SFMS3-30	3"	5	4.5	300	377.65
SFMS312-30	3.1/2"	5.5	5	350	376.75
SFMS4-30	4"	6	5	400	604.60
SFMS6-30	6"	7.5	2	600	1183.40

KELM™
pneumatiek

Hydrauliek

Snel-
koppelingen

Atsluiters

Roestvast
staal

Fittingen

Lucht-
conditionering

Gereedschap

Pneumatiek

Diversen

Malleabele
fittingen
& staal

Ringleiding-
systemen

Slangen

Compressoren

Oliebestendige zuigslang

Oliebestendige zuigslang is een robuuste slang voor algemene doeleinden. De slang heeft een gladde boring voor minimale stromingsweerstand. Goede plet- en weerbestendigheid. Wit ingekapseld nylon helixspiraal in een oliebestendig blauw pvc.

Vacuüm: 680mm Hg = 90% bij 20 °C

Drukwaarde: Opgegeven waarden zijn gebaseerd op kortstondige barstdruk van de slang bij 20 °C, veiligheidsfactor 3:1.

Opmerking: Iedere temperatuurverhoging boven 20 °C heeft een negatief effect op de druckbestendigheid.

Chemische weerstand: Geschikt voor olie, diesel, paraffine, hydraulische olie, smeerolie, minerale oliën en vetten.



Temperatuur:
-15°C tot +60°C

Blauw - 10 meter rol

	5998				€
BORS34-10		3/4"	3.5	8	30.75
BORS1-10		1"	4	8	40.60
BORS114-10		1.1/4"	4	7	42.20
BORS112-10		1.1/2"	4.5	7	69.30
BORS2-10		2"	4.5	6.5	101.15
BORS212-10		2.1/2"	4.5	5	95.45
BORS3-10		3"	5	4.5	168.40

Blauw - 30 meter rol

	5998				€
BORS34-30		3/4"	3.5	8	89.15
BORS1-30		1"	4	8	124.00
BORS114-30		1.1/4"	4	7	152.50
BORS112-30		1.1/2"	4.5	7	192.55
BORS2-30		2"	4.5	6.5	302.35
BORS212-30		2.1/2"	4.5	5	413.05
BORS3-30		3"	5	4.5	505.20

- KELM™ pneumatiek
- Hydrauliek
- Snelkoppelingen
- Afsluiters
- Roestvast staal
- Fittingen
- Luchtconditionering
- Gereedschap
- Pneumatiek
- Diversen
- Malleabele fittingen & staal
- Ringleidingssystemen
- Slangen**
- Compressoren

Industriële afzuigslang

High performance assortiment afzuigslangen, vervaardigd in Europa. Gemaakt van premium-grade ester polyurethaan samenstelling, versterkt met een veerstalen spiraal met koperen coating.

Toepassing:

Voor transport van abrasieve vaste stoffen zoals stof, poeder, vezels.

Ook geschikt voor het extractie van gasvormige media zoals olienevel en lasrook.

- Uitstekende slijtvastheid
- Spiraal kan geaard worden
- Zeer flexibel en lichtgewicht
- Kleine buigradius
- Goed bestandigheid tegen olie, benzine en chemicaliën
- Hoge treksterkte en scheurweerstand
- UV & ozonbestendig



Temperatuur:
-40°C tot +90°C

Korstondig:
+125°C

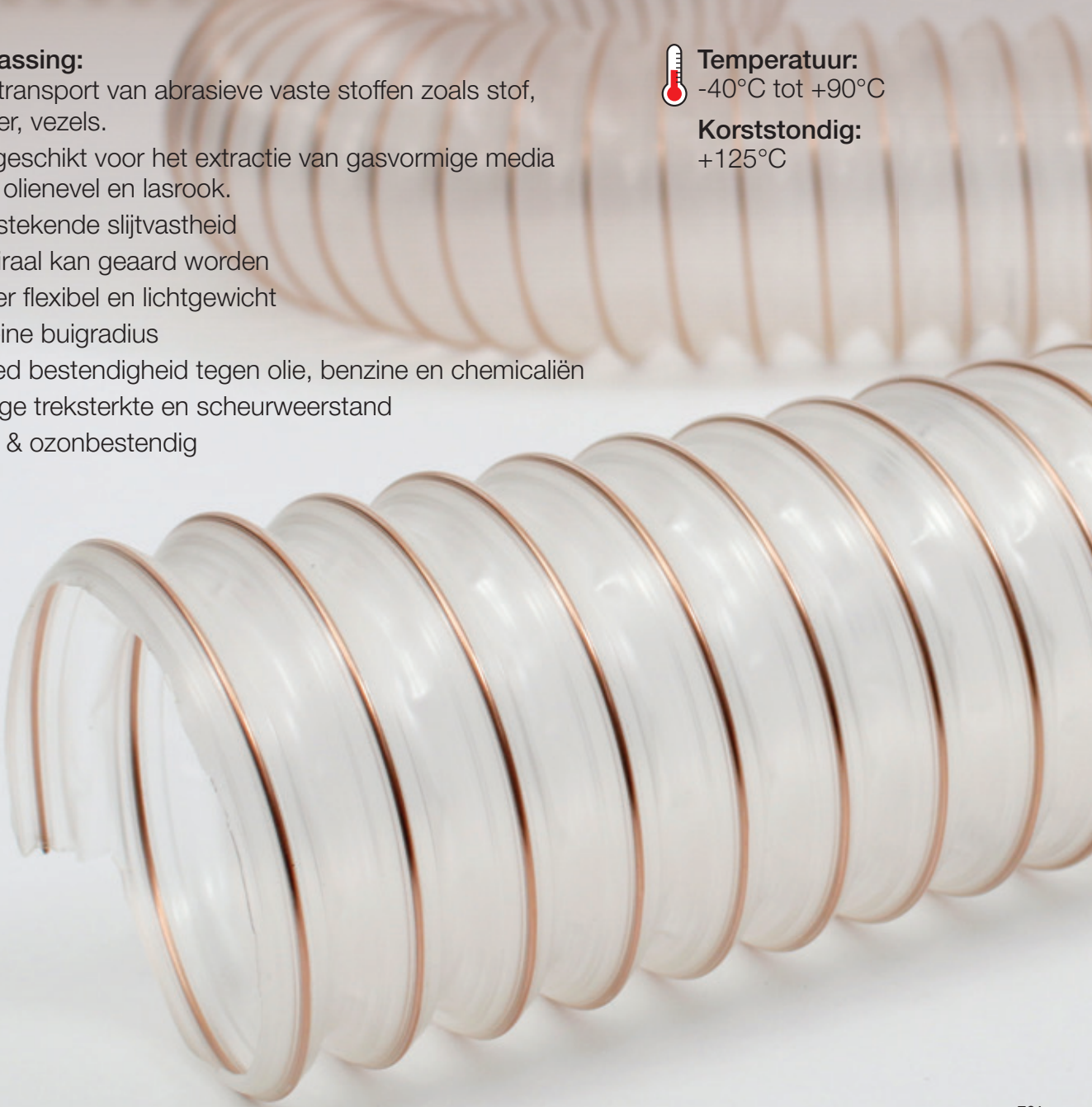

Industriële slangen



Wanddikte ca. 0.4mm

Geleverd in gecompriëerde vorm (4:1) voor ruimte- en kostenbesparing.



Temperatuur:
-40°C tot +90°C

Light polyurethaan afzuigslang



0.4mm wanddikte - 10 meter rol

0391	ID mm	OD mm	bar	Vacuum bar	kg per mtr	€
PURLW-38	38	45	0.61	0.265	0.220	140.60
PURLW-50	50	58	0.49	0.216	0.280	142.55
PURLW-60	60	68	0.41	0.171	0.340	144.95
PURLW-65	65	73	0.38	0.150	0.360	151.85
PURLW-75	75	83	0.33	0.117	0.410	166.80
PURLW-80	80	88	0.31	0.108	0.440	174.20
PURLW-90	90	98	0.29	0.090	0.490	186.05
PURLW-100	100	108	0.25	0.072	0.510	197.30
PURLW-115	115	123	0.22	0.064	0.580	219.10
PURLW-120	120	128	0.21	0.063	0.610	228.45
PURLW-125	125	133	0.20	0.050	0.630	235.25
PURLW-130	130	138	0.19	0.050	0.660	246.40
PURLW-140	140	148	0.18	0.050	0.710	262.65
PURLW-150	150	158	0.17	0.050	0.760	279.45
PURLW-160	160	168	0.16	0.043	0.810	298.15
PURLW-180	180	188	0.14	0.033	0.900	341.70
PURLW-200	200	208	0.12	0.033	1.030	375.30
PURLW-225	225	233	0.11	0.023	1.160	427.60
PURLW-250	250	258	0.10	0.015	1.280	459.30

Brugklem - type 212



Tech Data
10430

W2 - gegalvaniseerd staal

0391	To Suit Hose I.D. mm	€
212-0035-0000	38-45	12.00
212-0045-0000	50-55	12.00
212-0055-0000	60-65	13.35
212-0065-0000	70-75	14.50
212-0075-0000	80	16.70
212-0085-0000	90	17.15
212-0095-0000	100-102	17.40
212-0105-0000	110-115	18.65
212-0115-0000	120-127	19.80
212-0125-0000	130	20.75
212-0135-0000	140	20.75
212-0145-0000	150-152	25.50
212-0155-0000	160	25.80
212-0165-0000	170-175	27.00
212-0175-0000	180	27.65
212-0195-0000	200	32.25
212-0215-0000	225	36.70
212-0245-0000	250	39.85
212-0295-0000	300	57.00
212-0315-0000	315-325	58.75
212-0345-0000	350	61.85
212-0395-0000	400	64.75

Hoofdstuk 13 - Slangen

Medium polyurethaan afzuigslang



0.6mm wanddikte - 10 meter rol

0391	ID mm	OD mm	bar	Vacuum bar	kg per mtr	€
PURMW-38	38	45	1.060	0.320	0.250	150.00
PURMW-50	50	58	0.815	0.260	0.360	163.10
PURMW-60	60	68	0.680	0.210	0.430	170.55
PURMW-65	65	73	0.630	0.180	0.470	176.05
PURMW-75	75	83	0.545	0.140	0.530	199.15
PURMW-80	80	88	0.510	0.130	0.570	212.85
PURMW-90	90	98	0.455	0.115	0.630	219.10
PURMW-100	100	108	0.410	0.090	0.660	229.70
PURMW-115	115	123	0.355	0.080	0.760	255.75
PURMW-120	120	128	0.340	0.075	0.790	266.35
PURMW-125	125	133	0.330	0.060	0.820	275.65
PURMW-130	130	138	0.315	0.060	0.850	290.00
PURMW-140	140	148	0.295	0.060	0.920	306.85
PURMW-150	150	158	0.275	0.055	0.980	327.35
PURMW-160	160	168	0.255	0.050	1.040	349.10
PURMW-180	180	188	0.230	0.040	1.170	402.00
PURMW-200	200	208	0.205	0.040	1.540	439.35
PURMW-225	225	233	0.180	0.030	1.750	499.75
PURMW-250	250	258	0.165	0.015	1.900	537.10
PURMW-300	300	309	0.135	0.015	2.530	672.15
PURMW-350	350	359	0.115	0.010	2.950	790.40
PURMW-400	400	409	0.105	0.010	3.360	873.20

Polyurethaan afzuigslang - gladde boring

Toepassing:

Afzuiging en het transport van abrasieve stoffen zoals poeders, korrels, granulaten, vezels en stof in industriële ventilatie en luchtstroomsystemen. Ook voor gassen en vloeistoffen.

Voor gebruik met voedingsmiddelen volgens (EU) nr. 10/2011

- Heldere Ester basis PU met grijs spiraal
- Plet-, weer- en schokbestendig PVC spiraal
- Slijtvast en bestand tegen chemische stoffen
- Gladde boring voor een optimale doorstroming

Werktemperatuur:
-20°C tot +80°C



Tech Data
20559



20 meter rol

0391	ID mm	mm	€
PUSB-25-20	25	60	243.45
PUSB-38-20	38	78	375.00
PUSB-51-20	51	100	504.15
PUSB-76-20	76	145	735.25
PUSB-102-20	102	200	989.70
PUSB-127-20	127	250	1232.00

10 meter rol

0391	ID mm	mm	€
PUSB-25-10	25	60	121.70
PUSB-38-10	38	78	185.70
PUSB-51-10	51	100	252.05
PUSB-76-10	76	145	364.10
PUSB-102-10	102	200	494.85
PUSB-127-10	127	250	616.00
PUSB-152-10	152	305	719.85
PUSB-203-10	203	410	973.10

CRISTALLO FOOD slang

Geschikt voor food en perslucht, multifunctionele slang voor industrie, chemicaliën zonder oplosmiddelen, laboratoria e.d. Levensmiddelenkwaliteit volgens de Europese normen.

Temperatuur:
-20°C tot +60°C

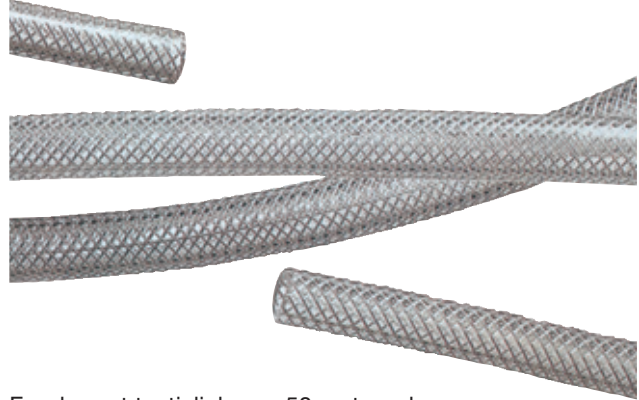

Food - met textielinlage - 50 meter rol

PVC	OD mm	ID mm	bar		€
23201610	16	10	20	Transparant	99.50
23201913	19	13	12	Transparant	124.20
23202216	22	16	10	Transparant	150.90
23202619	26	19	10	Transparant	207.85

Food - met textielinlage - 100 meter rol

PVC	OD mm	ID mm	bar		€
23201206	12	6	20	Transparant	145.30

KELM™
pneumatiek

Hydrauliek

Snel-
koppelingen

Atsluiters

Roestvast
staal

Fittingen

Lucht-
conditionering

Gereedschap

Pneumatiek

Diversen

Malleabele
fittingen
& staal

Ringleiding-
systemen

Slangen

Compressoren

Antistatische slang - BS2050

Duurzame slang, geheel rubber samenstelling.
Conform de vereisten van BS2050 specificatie voor 20 bar werkdruk.

- Geschikt voor alle persluchttoepassingen.
- Geschikt voor gebruik op plaatsen waar antistatische eigenschappen de voorkeur hebben, zoals raffinaderijen en offshore olie- en gastoeepassingen.

Constructie:

Voering: Elektrisch geleidende SBR rubber.

Buitenmantel: Egaal zwart SBR rubber.

Temperatuur:
-20°C to +80°C

Maximale werkdruk:
20 bar

100 meter rol

SLAN	ID	OD mm	bar	bar	€
ASAH-1/4-100	1/4"	14	20	60	121.85
ASAH-5/16-100	5/16"	16	20	60	155.10
ASAH-3/8-100	3/8"	18	20	60	195.05
ASAH-1/2-100	1/2"	22	20	60	298.35
ASAH-5/8-100	5/8"	26	20	60	393.30

60 meter rol

SLAN	ID	OD mm	bar	bar	€
ASAH-3/4-60	3/4"	30	20	60	323.55
ASAH-1-60	1"	36	20	60	392.70

20 meter rol

SLAN	ID	OD mm	bar	bar	€
ASAH-1/4-20	1/4"	14	20	60	24.35
ASAH-5/16-20	5/16"	16	20	60	31.00
ASAH-3/8-20	3/8"	18	20	60	39.00
ASAH-1/2-20	1/2"	22	20	60	59.70
ASAH-5/8-20	5/8"	26	20	60	78.65
ASAH-3/4-20	3/4"	30	20	60	107.85
ASAH-1-20	1"	36	20	60	130.90

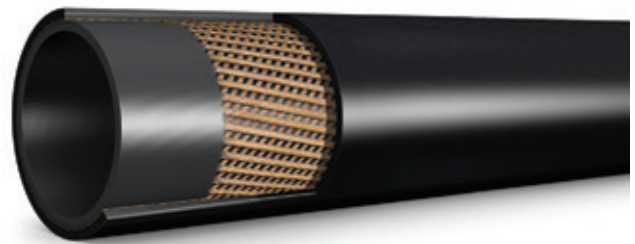

- **tst** (drukknop) snelkoppelingen & insteeknippels vanaf pagina 257



Diverse slangen



TWT PTFE slang

Zeer goede temperatuur- en chemische bestendigheid. Zuur-, loog-, olie- en benzinebestendig.

De werkdruk is zeer afhankelijk van de temperatuur.

Gecalibreerd volgens kwaliteitsnorm BS EN ISO 13000-1:2003

Andere maten of uitvoeringen zijn op aanvraag leverbaar.

Als gevolg van milieuvriendelijke productie methoden kunnen de rollengtes van de bovenstaande PTFE slangen afwijken of worden onderbroken.

Onderbrekingen worden met een gekleurde plakker aangegeven

Temperatuur:
-73°C tot +260°C



Food - 25 meter rol

SLAN	OD mm	ID mm	bar		L m	€
24100604	6	4	16	Naturel	± 25	138.00
24100806	8	6	11	Naturel	± 25	196.10

Food - 100 meter rol

SLAN	OD mm	ID mm	bar		L m	€
24200604	6	4	16	Naturel	± 100	543.05
24200806	8	6	11	Naturel	± 100	784.15
24200810	10	8	10	Naturel	± 100	846.25
24201114	14	11	10	Naturel	± 100	1901.20
24201215	15	12	10	Naturel	± 100	2172.05

Vinnylan slang

Deze vinnylan luchtslang is een bijzondere kwaliteitsslang die zich onderscheidt door de volgende kenmerken:

- Zeer fijn synthetisch geweven beschermmantel.
- Zeer flexibel en lichtgewicht.
- Vergaand chemisch bestendig tegen olie, benzine, verdunde zuren & logen
- Dunwandig.
- Slijtvast.

Temperatuur:
-30°C tot +80°C

Maximale werkdruk:
25 bar



50 meter rol

SLAN	OD mm	ID mm	bar		L m	€
80706204	6,2	4	40	Blauw	50	186.95
80708206	8,2	6	40	Blauw	50	196.60
80701008	10,2	8	35	Blauw	50	220.35
80701109	11,6	9	30	Blauw	50	224.50
80701210	12,5	10	28	Blauw	50	394.95
80701713	17,6	13	28	Blauw	50	408.10

Vinnylan FOOD slang

- Voor drinkwater, voedingsstoffen, perslucht en ademlucht.
- Laat geen geur of smaak na. Geschikt voor opsteekkoppelingen.
- Deze slang is zeer slijtvast, lichtgewicht en bestand tegen waterslag. Tevens zeer goed bestand tegen UV licht.
- Door de fijne kruisweving treedt bij 8 bar ca. 2% lengtekrimp op.
- Vergaand chemisch bestendig tegen olie, benzine, verdunde zuren & logen

Temperatuur:
-10°C tot +60°C



Food - 50 meter rol

SLAN	OD mm	ID mm	bar		L m	€
81708206	8,2	6	40	Zwart	50	181.50

Siliconenslang

Voor drinkwater, koffiemachines, voedingsstoffen etc.

Gecalibreerd volgens

UNI 3302 CL.E2

Hardheid = 60 ° shore



Temperatuur:
-60°C tot +200°C

Maximale werkdruk:
4 bar



Food - 50 meter rol - rollengtes kunnen afwijken

SLAN	OD mm	ID mm		L m	€
SIL64	6	4	Transparant	50	43.20
SIL74	7	4	Transparant	50	69.10
SIL75	7	5	Transparant	50	47.90
SIL85	8	5	Transparant	50	78.55
SIL86	8	6	Transparant	50	65.20
SIL96	9	6	Transparant	50	98.40
SIL106	10	6	Transparant	50	134.55
SIL118	11	8	Transparant	50	139.00
SIL128	12	8	Transparant	50	167.80

KELM™
pneumatiek

Hydrauliek

Snel-
koppelingen

Atsluiters

Roestvast
staal

Fittingen

Lucht-
conditionering

Gereedschap

Pneumatiek

Diversen

Malleabele
fittingen
& staal

Ringleiding-
systemen

Slangen

Compressoren

Spiraalslangen

Tech Data 3133

PU spiraalslang

Ook verkrijgbaar in blauw en geel.

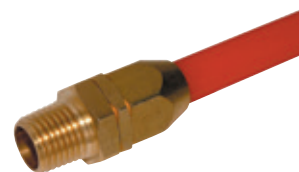
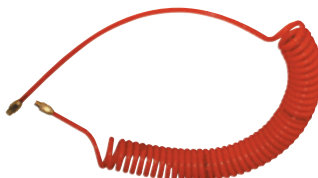

Draaibare koppeling -
blank messing - BSPT male

5030	OD mm	ID mm	-m-	W	€
------	-------	-------	-----	---	---

28800604	6	4	2	1/4"	Geel	12.85
28810604	6	4	4	1/4"	Geel	16.10
2196-4200	6	4	6	1/4"	Geel	15.10
2196-4201	6	4	8	1/4"	Geel	14.90
2196-4202	6	4	10	1/4"	Geel	16.55
2196-4203	8	5	2	1/4"	Geel	12.95
2196-4204	8	5	4	1/4"	Geel	15.75
2196-4205	8	5	6	1/4"	Geel	18.95
2196-4206	8	5	8	1/4"	Geel	20.45
2196-4207	8	5	10	1/4"	Geel	23.60
2196-4208	8	5	12	1/4"	Geel	25.30
28801065	10	6.5	2	1/4"	Geel	19.30
28811065	10	6.5	4	1/4"	Geel	24.45
28821065	10	6.5	6	1/4"	Geel	32.15
28831065	10	6.5	8	1/4"	Geel	41.50
2196-4209	10	6.5	10	1/4"	Geel	35.75
2196-4210	10	6.5	12	1/4"	Geel	35.70
28801208	12	8	2	3/8"	Geel	29.60
28811208	12	8	4	3/8"	Geel	31.60
28821208	12	8	6	3/8"	Geel	48.60
28831208	12	8	8	3/8"	Geel	57.25
2196-4211	12	8	10	3/8"	Geel	46.80
2196-4212	12	8	12	3/8"	Geel	47.60

5030	OD mm	ID mm	-m-	W	€
------	-------	-------	-----	---	---

28980604	6	4	2	1/4"	Rood	12.85
28910604	6	4	4	1/4"	Rood	15.85
2196-4213	6	4	6	1/4"	Rood	15.20
2196-4214	6	4	8	1/4"	Rood	16.45
2196-4215	6	4	10	1/4"	Rood	16.55
28800805	8	5	2	1/4"	Rood	11.15
28810805	8	5	4	1/4"	Rood	13.85
28820805	8	5	6	1/4"	Rood	18.00
28830805	8	5	8	1/4"	Rood	20.15
28840805	8	5	10	1/4"	Rood	26.65
28850805	8	5	12	1/4"	Rood	30.15
28961065	10	6.5	2	1/4"	Rood	17.20
28971065	10	6.5	4	1/4"	Rood	24.45
28981065	10	6.5	6	1/4"	Rood	32.25
28991065	10	6.5	8	1/4"	Rood	39.35
28901065	10	6.5	10	1/4"	Rood	52.75
28911065	10	6.5	12	1/4"	Rood	58.05
28701208	12	8	2	3/8"	Rood	26.45
28711208	12	8	4	3/8"	Rood	35.45
28721208	12	8	6	3/8"	Rood	49.45
28731208	12	8	8	3/8"	Rood	56.45
28741208	12	8	10	3/8"	Rood	75.60
28751208	12	8	12	3/8"	Rood	84.40

5030	OD mm	ID mm	-m-	W	€
------	-------	-------	-----	---	---

28860604	6	4	2	1/4"	Blauw	12.60
28870604	6	4	4	1/4"	Blauw	15.20
2196-4216	6	4	6	1/4"	Blauw	14.95
2196-4217	6	4	8	1/4"	Blauw	16.45
2196-4218	6	4	10	1/4"	Blauw	18.70
2196-4219	8	5	2	1/4"	Blauw	12.95
2196-4220	8	5	4	1/4"	Blauw	15.85
2196-4221	8	5	6	1/4"	Blauw	19.15
2196-4222	8	5	8	1/4"	Blauw	22.40
2196-4223	8	5	10	1/4"	Blauw	26.05
2196-4224	8	5	12	1/4"	Blauw	27.50
28861065	10	6.5	2	1/4"	Blauw	16.55
28871065	10	6.5	4	1/4"	Blauw	23.15
28881065	10	6.5	6	1/4"	Blauw	32.25
28891065	10	6.5	8	1/4"	Blauw	36.85
2196-4225	10	6.5	10	1/4"	Blauw	34.40
2196-4226	10	6.5	12	1/4"	Blauw	39.00
28901208	12	8	2	3/8"	Blauw	29.40
28911208	12	8	4	3/8"	Blauw	32.80
28921208	12	8	6	3/8"	Blauw	48.60
28931208	12	8	8	3/8"	Blauw	56.90
2196-4227	12	8	10	3/8"	Blauw	46.60
2196-4228	12	8	12	3/8"	Blauw	47.60

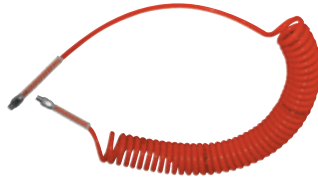

Draaibare koppeling met anti-knikveer -
messing vernikkeld - BSPT male

5030	OD mm	ID mm	-m-	W	€
------	-------	-------	-----	---	---

2196-4229	6	4	2	1/4"	Geel	17.75
2196-4230	6	4	4	1/4"	Geel	23.30
2196-4231	6	4	6	1/4"	Geel	23.30
2196-4232	6	4	8	1/4"	Geel	19.70
2196-4233	6	4	10	1/4"	Geel	27.15
2196-4234	8	5	2	1/4"	Geel	21.45
2196-4235	8	5	4	1/4"	Geel	21.10
2196-4236	8	5	6	1/4"	Geel	28.25
2196-4237	8	5	8	1/4"	Geel	31.90
2196-4238	8	5	10	1/4"	Geel	35.55
2196-4239	8	5	12	1/4"	Geel	37.70
2196-4240	10	6.5	2	1/4"	Geel	26.55
2196-4241	10	6.5	4	1/4"	Geel	27.85
2196-4242	10	6.5	6	1/4"	Geel	34.20
2196-4243	10	6.5	8	1/4"	Geel	45.30
2196-4244	10	6.5	10	1/4"	Geel	47.55
2196-4245	10	6.5	12	1/4"	Geel	52.45
2196-4246	12	8	2	3/8"	Geel	40.75
2196-4247	12	8	4	3/8"	Geel	44.85
2196-4248	12	8	6	3/8"	Geel	54.85
2196-4249	12	8	8	3/8"	Geel	60.60
2196-4250	12	8	10	3/8"	Geel	63.60
2196-4251	12	8	12	3/8"	Geel	69.35

5030	OD mm	ID mm	-m-	W	€
------	-------	-------	-----	---	---

2196-4252	6	4	2	1/4"	Rood	17.70
2196-4253	6	4	4	1/4"	Rood	18.70
2196-4254	6	4	6	1/4"	Rood	19.65
2196-4255	6	4	8	1/4"	Rood	25.10
2196-4256	6	4	10	1/4"	Rood	27.15
2196-4257	8	5	2	1/4"	Rood	19.60
2196-4258	8	5	4	1/4"	Rood	25.35
2196-4259	8	5	6	1/4"	Rood	27.05
2196-4260	8	5	8	1/4"	Rood	29.35
2196-4261	8	5	10	1/4"	Rood	33.10
2196-4262	8	5	12	1/4"	Rood	42.75
2196-4263	10	6.5	2	1/4"	Rood	25.80
2196-4264	10	6.5	4	1/4"	Rood	29.40
2196-4265	10	6.5	6	1/4"	Rood	35.30
2196-4266	10	6.5	8	1/4"	Rood	45.30
2196-4267	10	6.5	10	1/4"	Rood	45.20
2196-4268	10	6.5	12	1/4"	Rood	57.85
2196-4269	12	8	2	3/8"	Rood	34.70
2196-4270	12	8	4	3/8"	Rood	37.90
2196-4271	12	8	6	3/8"	Rood	54.85
2196-4272	12	8	8	3/8"	Rood	60.60
2196-4273	12	8	10	3/8"	Rood	69.35
2196-4274	12	8	12	3/8"	Rood	80.90

5030	OD mm	ID mm	-m-	W	€
------	-------	-------	-----	---	---

2196-4275	6	4	2	1/4"	Blauw	17.40
2196-4276	6	4	4	1/4"	Blauw	19.50
2196-4277	6	4	6	1/4"	Blauw	23.30
2196-4278	6	4	8	1/4"	Blauw	21.15
2196-4279	6	4	10	1/4"	Blauw	21.20
2196-4280	8	5	2	1/4"	Blauw	18.25
2196-4281	8	5	4	1/4"	Blauw	21.10
2196-4282	8	5	6	1/4"	Blauw	28.25
2196-4283	8	5	8	1/4"	Blauw	31.90
2196-4284	8	5	10	1/4"	Blauw	35.55
2196-4285	8	5	12	1/4"	Blauw	37.70
2196-4286	10	6.5	2	1/4"	Blauw	31.20
2196-4287	10	6.5	4	1/4"	Blauw	29.20
2196-4288	10	6.5	6	1/4"	Blauw	35.10
2196-4289	10	6.5	8	1/4"	Blauw	45.30
2196-4290	10	6.5	10	1/4"	Blauw	47.55
2196-4291	10	6.5	12	1/4"	Blauw	52.45
2196-4292	12	8	2	3/8"	Blauw	37.90
2196-4293	12	8	4	3/8"	Blauw	37.85
2196-4294	12	8	6	3/8"	Blauw	54.85
2196-4295	12	8	8	3/8"	Blauw	60.60
2196-4296	12	8	10	3/8"	Blauw	63.60
2196-4297	12	8	12	3/8"	Blauw	69.35

PU spiraalslang Coilhose® - Type PUC

Ontwikkeld om de twee meest voorkomende beperkingen van Nylon slang uit te sluiten: knikbestendigheid en vochtbestendigheid. Deze lichtgewicht slang is extreem flexibel en knikvrij, tevens slijtvrij en tevens bestand tegen olie (niet zuurbestendig).

Door de elasticiteit en kleine buigradius is deze slang zeer geschikt voor gebruik in kleine ruimtes. Toepassing: productielijn luchtgereedschap, instrumentatie, robotica en vele andere industriële applicaties.

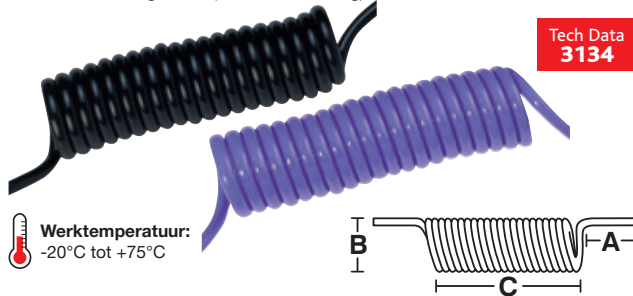

Tech Data
3134

Werktemperatuur:
-20°C tot +75°C

Zonder koppelingen

5030	OD mm	ID mm	A mm	B mm	C mm	W	M	€
PUC4/1	4	2.5	80	26	60	1	Zwart	3.75
PUC4/2	4	2.5	80	26	120	2	Zwart	4.10
PUC6/1	6	4	120	37	51	1	Zwart	4.40
PUC6/2	6	4	120	37	120	2	Zwart	4.55
PUC6/3	6	4	120	37	185	3	Zwart	6.10
PUC8/2	8	5	150	47	140	2	Zwart	6.50
PUC8/3	8	5	150	47	210	3	Zwart	7.85
PUC8/5	8	5	150	47	345	5	Zwart	11.25
PUC4/1B	4	2.5	80	26	60	1	Blauw	3.75
PUC4/2B	4	2.5	80	26	120	2	Blauw	4.10
PUC6/1B	6	4	120	37	51	1	Blauw	4.15
PUC6/2B	6	4	120	37	120	2	Blauw	4.95
PUC6/3B	6	4	120	37	185	3	Blauw	5.25
PUC8/2B	8	5	150	47	140	2	Blauw	6.45
PUC8/3B	8	5	150	47	210	3	Blauw	7.80
PUC8/5B	8	5	150	47	345	5	Blauw	11.55



Tech Data
3135

Vaste koppeling - blank messing - BSPT male

5030	OD mm	W	M	€
PUC4/1-18	4	1	1/8"	6.00
PUC4/1-14	4	1	1/4"	6.00
PUC4/2-18	4	2	1/8"	6.45
PUC4/2-14	4	2	1/4"	6.45
PUC6/1-18	6	1	1/8"	6.55
PUC6/1-14	6	1	1/4"	6.55
PUC6/2-18	6	2	1/8"	7.45
PUC6/2-14	6	2	1/4"	7.45
PUC6/3-18	6	3	1/8"	8.55
PUC6/3-14	6	3	1/4"	8.55
PUC8/2-14	8	2	1/4"	10.00
PUC8/2-38	8	2	3/8"	10.00
PUC8/3-14	8	3	1/4"	10.35
PUC8/5-14	8	5	1/4"	14.00

Draaibare opsteekkoppeling voor PU slang



Messing vernikkeld - met anti-knikveer - BSPT male

5030	Passend op	W	M	€
PF0406-14-NG	6/4	1/4"		2.85
PF0508-14-NG	8/5	1/4"		3.05
PF0610-14-NG	10/6.5	1/4"		4.05
PF0812-14-NG	12/8	1/4"		5.15
PF0812-38-NG	12/8	3/8"		5.10



Blank messing - BSPT male

5030	Passend op	W	M	€
PF0406-14	6/4	1/4"		2.55
PF0508-14	8/5	1/4"		2.85
PF0610-14	10/6.5	1/4"		3.20
PF0812-14	12/8	1/4"		4.85
PF0812-38	12/8	3/8"		4.75

Hoofdstuk 13 - Slangen

KELM™ pneumatiek
Hydrauliek
Snelkoppelingen
Afsluiters
Roestvast staal
Fittingen
Luchtconditionering
Gereedschap
Pneumatiek
Diversen
Malleabele fittingen & staal
Ringleidingssystemen
Slangen
Compressoren

• **tst** (drukknop) snelkoppelingen & insteeknippels vanaf pagina 257



PU spiraalslang - met blaaspistool

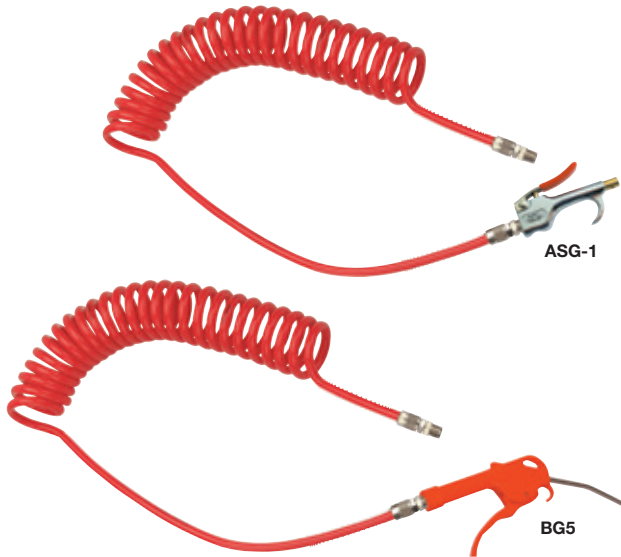

BSPT male

	5030	OD mm	ID mm	~mtrs~	BSPT	Blow Gun Type	€
	2027-3967	6	4	2	1/4"	ASG-1	19.55
	2027-3975	6	4	4	1/4"	ASG-1	21.55
Hydrauliek	2027-4007	6	4	2	1/4"	BG5	15.40
	2027-4015	6	4	4	1/4"	BG5	16.85
Snel- koppelingen	2027-4023	10	6.5	2	1/4"	ASG-1	26.00
	2025-2763	10	6.5	4	1/4"	ASG-1	28.95
	2027-4049	10	6.5	6	1/4"	ASG-1	34.95
Afsluiters	2027-4056	10	6.5	2	1/4"	BG5	21.60
	2027-4064	10	6.5	4	1/4"	BG5	24.60
Roestvast staal	2027-4072	10	6.5	6	1/4"	BG5	30.65

PU DUO spiraalslang

Werktemperatuur:
-20°C tot +70°C

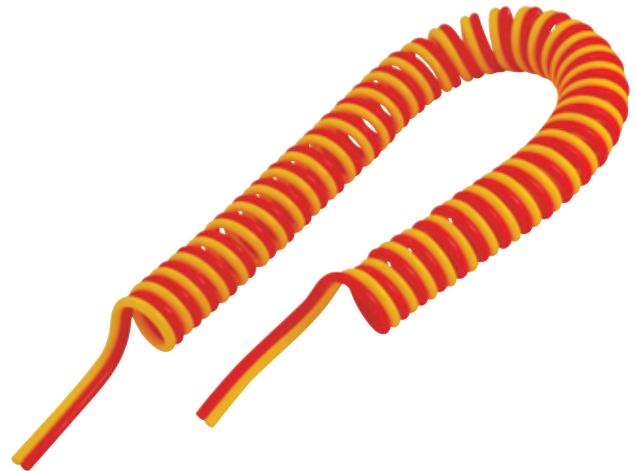

Zonder koppelingen

	5030	OD mm	ID mm	~mtrs~		€
	TWIN80505RY	8	5	2.5	Rood/Geel	27.35
	TWIN10656RY	10	6.5	3	Rood/Geel	41.05
	TWIN12806RY	12	8	3	Rood/Geel	52.60

• Voor drukknop veiligheidsnelkoppelingen conform ARB0/ISO 4414 zie pagina 257 en 262

• Met Euro, Orion & ISO 6150-C profiel



Spiraalslangen

PA Nylon 12 spiraalslang

Werktemperatuur:
-40°C tot +80°C

- Veiligheidsfactor: 3 tot 1
- Bestand tegen een breed scala aan chemicaliën
- Olie- en benzinebestendig (niet zuurbestendig)

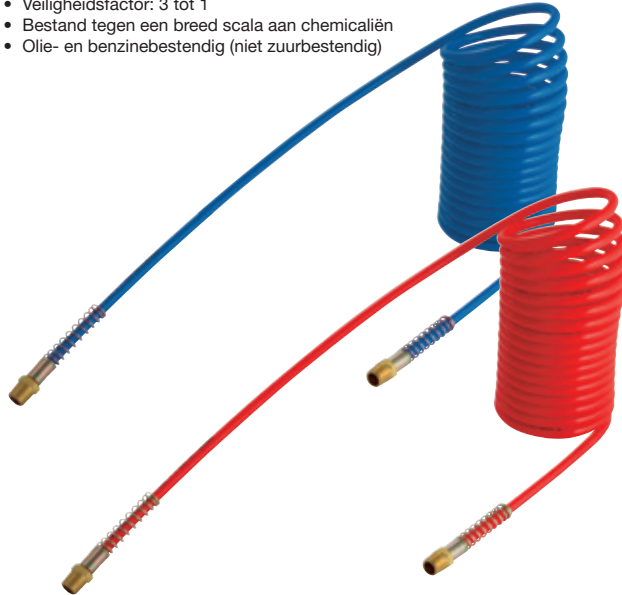

Tech Data
3138

Maximale werkdruk:
12 bar

Tech Data
20150

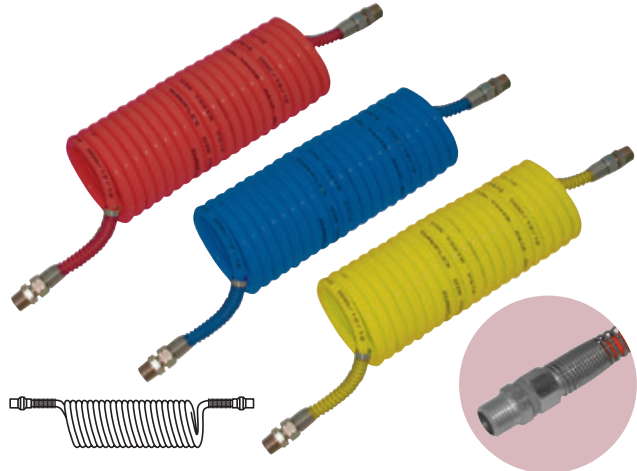

Rood - draaibare koppeling met anti-knikveer - messing vernikkeld - BSPT male

0306	OD mm	OD	ID mm	ID	-m-	-ft-		€
NRH516-12R	8	5/16"	6	1/4"	3.6	12	1/4"	25.10
NRH516-25R	8	5/16"	6	1/4"	7.6	25	1/4"	37.70
NRH516-40R	8	5/16"	6	1/4"	12.2	40	1/4"	50.50
NRH38-12R	10	3/8"	8	5/16"	3.6	12	1/4"	28.80
NRH38-25R	10	3/8"	8	5/16"	7.6	25	1/4"	44.30
NRH38-40R	10	3/8"	8	5/16"	12.2	40	1/4"	59.30
NRH12-12R	13	1/2"	10	3/8"	3.6	12	3/8"	52.45
NRH12-25R	13	1/2"	10	3/8"	7.6	25	3/8"	100.05
NRH12-40R	13	1/2"	10	3/8"	12.2	40	3/8"	126.95

Vaste koppeling met anti-knikveer - blank messing - BSPT male

0306	OD mm	ID mm	-m-		bar		€
N12C60402.5MB	6	4	2,5	1/4"	24	Blauw	12.70
N12C60405MB	6	4	5	1/4"	24	Blauw	16.85
N12C604010MB	6	4	10	1/4"	24	Blauw	25.45
N12C604015MB	6	4	15	1/4"	24	Blauw	32.60
N12C60402.5MR	6	4	2,5	1/4"	24	Rood	12.70
N12C60405MR	6	4	5	1/4"	24	Rood	16.85
N12C604010MR	6	4	10	1/4"	24	Rood	25.45
N12C604015MR	6	4	15	1/4"	24	Rood	32.60
N12C80602.5MB	8	6	2,5	1/4"	24	Blauw	14.30
N12C80605MB	8	6	5	1/4"	24	Blauw	19.95
N12C806010MB	8	6	10	1/4"	24	Blauw	30.85
N12C806015MB	8	6	15	1/4"	24	Blauw	41.70
N12C80602.5MR	8	6	2,5	1/4"	24	Rood	14.30
N12C80605MR	8	6	5	1/4"	24	Rood	19.95
N12C806010MR	8	6	10	1/4"	24	Rood	30.85
N12C806015MR	8	6	15	1/4"	24	Rood	41.70
N12C100802.5MB	10	8	2,5	1/4"	15	Blauw	19.00
N12C100805MB	10	8	5	1/4"	15	Blauw	26.10
N12C1008010MB	10	8	10	1/4"	15	Blauw	40.00
N12C1008015MB	10	8	15	1/4"	15	Blauw	54.15
N12C100802.5MR	10	8	2,5	1/4"	15	Rood	19.00
N12C100805MR	10	8	5	1/4"	15	Rood	26.10
N12C1008010MR	10	8	10	1/4"	15	Rood	40.00
N12C1008015MR	10	8	15	1/4"	15	Rood	54.15
N12C120902.5MB	12	9	2,5	3/8"	17	Blauw	26.55
N12C120905MB	12	9	5	3/8"	17	Blauw	39.10
N12C1209010MB	12	9	10	3/8"	17	Blauw	63.45
N12C1209015MB	12	9	15	3/8"	17	Blauw	86.45
N12C120902.5MR	12	9	2,5	3/8"	17	Rood	26.55
N12C120905MR	12	9	5	3/8"	17	Rood	39.10
N12C1209010MR	12	9	10	3/8"	17	Rood	63.45
N12C1209015MR	12	9	15	3/8"	17	Rood	86.45

Blauw - draaibare koppeling met anti-knikveer - messing vernikkeld - BSPT male

0306	OD mm	OD	ID mm	ID	-m-	-ft-		€
NRH516-12B	8	5/16"	6	1/4"	3.6	12	1/4"	25.80
NRH516-25B	8	5/16"	6	1/4"	7.6	25	1/4"	37.85
NRH516-40B	8	5/16"	6	1/4"	12.2	40	1/4"	48.15
NRH38-12B	10	3/8"	8	5/16"	3.6	12	1/4"	31.20
NRH38-25B	10	3/8"	8	5/16"	7.6	25	1/4"	45.70
NRH38-40B	10	3/8"	8	5/16"	12.2	40	1/4"	61.35
NRH12-12B	13	1/2"	10	3/8"	3.6	12	3/8"	50.50
NRH12-25B	13	1/2"	10	3/8"	7.6	25	3/8"	100.05
NRH12-40B	13	1/2"	10	3/8"	12.2	40	3/8"	131.95

Geel - draaibare koppeling met anti-knikveer - messing vernikkeld - BSPT male

0306	OD mm	OD	ID mm	ID	-m-	-ft-		€
NRH516-12Y	8	5/16"	6	1/4"	3.6	12	1/4"	24.00
NRH516-25Y	8	5/16"	6	1/4"	7.6	25	1/4"	36.00
NRH516-40Y	8	5/16"	6	1/4"	12.2	40	1/4"	48.10
NRH38-12Y	10	3/8"	8	5/16"	3.6	12	1/4"	30.55
NRH38-25Y	10	3/8"	8	5/16"	7.6	25	1/4"	47.00
NRH38-40Y	10	3/8"	8	5/16"	12.2	40	1/4"	59.75
NRH12-12Y	13	1/2"	10	3/8"	3.6	12	3/8"	53.85
NRH12-25Y	13	1/2"	10	3/8"	7.6	25	3/8"	102.65
NRH12-40Y	13	1/2"	10	3/8"	12.2	40	3/8"	131.95

KELM™
pneumatiek

Hydrauliek

Snelkoppelingen

Atsluiters

Roestvast
staal

Fittingen

Lucht-
conditionering

gereedschap

Pneumatiek

Diversen

Malleabele
fittingen
& staal

Ringleiding-
systemen

Slangen

Compressoren

Spiraalslangen



Hoofdstuk 13 - Slangen

Industriële PU spiraalslang



Elastisch & knikvrij

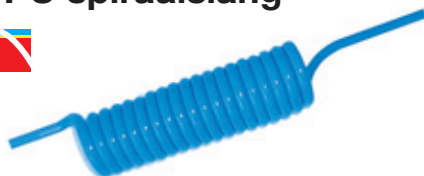

Zonder koppelingen - diverse lengtes

SPSK	OD mm	ID mm	-m-	bar		€
28200805	8	5	4	12	Blauw	47.15
28210805	8	5	6	12	Blauw	54.85
28220805	8	5	8	12	Blauw	65.55
28261065	10	6.5	2	12	Blauw	39.70
28271065	10	6.5	4	12	Blauw	71.10
28281065	10	6.5	6	12	Blauw	71.75
28291065	10	6.5	8	12	Blauw	87.25
28231208	12	8	4	12	Blauw	68.30
28241208	12	8	6	12	Blauw	89.70
28251208	12	8	8	12	Blauw	111.00

PA DUO spiraalslang



PA-Nylon 11/12 spiraalslang.
Niet zuurbestendig,
wel olie- &
bezeinebestendig.



Zonder koppelingen - 10 meter lengte

SPSK	OD mm	ID mm		-m-	€
18890604	6	4	Zwart/Blauw	10	181.70
18890806	8	6	Zwart/Blauw	10	158.05
18891008	10	8	Zwart/Blauw	10	228.30

Flexi-Braid heavy duty PU spiraalslang

Tech Data
20345



Heavy duty PU spiraalslang met
textielinlage & draaibare koppelingen.
Zeer slijtvast, lichtgewicht,
knikvrij & flexibel.



Temperatuur:
-20°C tot +75°C

**Maximale
werkdruk:**
12 bar bij 20°C

1/4" draaibare koppelingen - diverse lengtes

SPSK	OD mm	ID mm		-m-	€
28841065	10	6.5	1/4"	5	38.55
28851065	10	6.5	1/4"	7.5	52.80
28841208	12	8	1/4"	5	55.50
28851208	12	8	1/4"	7.5	74.45

Draaibare inschroefkoppeling

LUDECKE



Met kunststof anti-knikveer - BSP male met PTFE coating

SPSK	OD mm	ID mm	BSPT	€
DVK5814	8	5	1/4"	15.45
DVK651014	10	6.5	1/4"	16.40
DVK81214	12	8	1/4"	17.40
DVK81238	12	8	3/8"	17.40
DVK11612	16	11	1/2"	32.90
SVS131934	19	13	3/4"	28.35

PA Nylon 12 luchtremspiraal - DIN 73378 - SAE J 844 Type B



Temperatuurbereik:
-40°C tot +80°C

- Bestand tegen een breed scala aan chemicaliën
- Vervaardigd uit superieure kwaliteit grondstoffen. De eigenschappen van deze slang zorgen ervoor dat de slang zeer geschikt is voor gebruik in een vochtige atmosfeer.

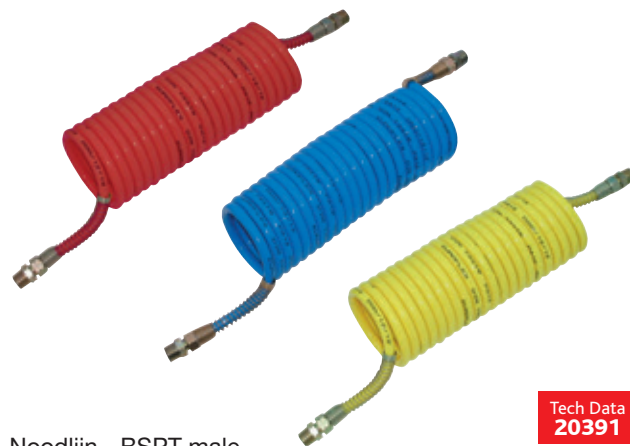

Tech Data
20391

Noodlijn - BSPT male

SPSK	ID mm	OD mm	-m-	BSPT		€
AB129035R	9	12	3.5	1/2"	16	Rood 41.60
AB129050R	9	12	5	1/2"	22	Rood 50.50

Hulplijn - BSPT male

SPSK	ID mm	OD mm	-m-	BSPT		€
AB129035B	9	12	3.5	1/2"	16	Blauw 48.25
AB129050B	9	12	5	1/2"	22	Blauw 58.55

Dienstlijn - BSPT male

SPSK	ID mm	OD mm	-m-	BSPT		€
AB129035Y	9	12	3.5	1/2"	16	Geel 50.50
AB129050Y	9	12	5	1/2"	22	Geel 58.55

kiwa



Koperen buis



Naadloos getrokken halfharde koperen waterleidingbuis - KIWA/Gastec keur - 3 meter lengte

KOPB	OD mm	ID mm	bar	bar	L m	€
KKOPB12	12	10	25	100	3	47.90
KKOPB15	15	13	20	80	3	58.25
KKOPB22	22	19.8	15	60	3	98.05



Tech Data
820

Gegloeide koperen buis - BS2871/2/C106 (EN1057) - 10 meter rol

KOPB	OD mm	ID mm	bar	bar	L m	€
MCT-4	4	2.8	137	685	10	29.40
MCT-6	6	4.4	121	605	10	35.80
MCT-8	8	6.4	91	455	10	58.85
MCT-10	10	8.4	72	360	10	88.20
MCT-12	12	10.4	68	340	10	103.45

Gegloeide koperen buis - BS2871/2/C106 (EN1057) - 30 meter rol

KOPB	OD mm	ID mm	bar	bar	L m	€
MCT-4/30	4	2.8	137	685	30	95.80
MCT-6/30	6	4.4	121	605	30	108.10
MCT-8/30	8	6.4	91	455	30	175.30
MCT-10/30	10	8.4	72	360	30	217.60
MCT-12/30	12	10.4	68	340	30	273.40

JG

Aluminium buis

Blauw gecoate buis voor persluchtinstallaties.

Tech Data
20629

3 meter lengte

1401	bar	OD mm	ID mm	bar	L m	€
AL-RM1512-3M	20	15	13	Blauw	3	26.30
AL-RM1814-3M	20	18	16	Blauw	3	39.20
AL-RM2218-3M	20	22	20	Blauw	3	39.35
AL-RM2823-3M	20	28	26	Blauw	3	63.40



PA12 buis

Harde PA buis voor persluchtinstallaties.

Tech Data
20629

3 meter lengte

1401	bar	OD mm	ID mm	bar	L m	€
PA-RM1209-3M	32	12	9	Blauw	3	11.55
PA-RM1512-3M	25	15	12	Blauw	3	13.15
PA-RM1814-3M	28	18	14	Blauw	3	23.15
PA-RM2218-3M	22	22	18	Blauw	3	28.90
PA-RM2823-3M	20	28	23	Blauw	3	44.85

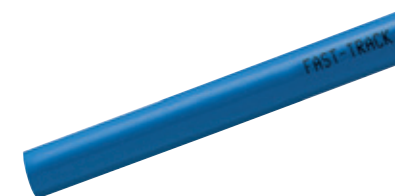

B-pex buis

Flexibel en zuurstofdicht. Voor drinkwater, verwarming en koeling.

Tech Data
20363

3 meter lengte

1401	bar	OD mm	bar	L m	€
1400153M	12	15	Wit	3	11.10
1400223M	12	22	Wit	3	21.85

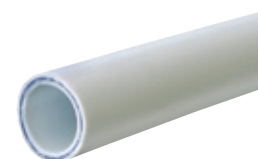

JG Speedfit®

koppelingen voor
sanitair, verwarmings-
en koelsystemen zijn
op aanvraag leverbaar



KELM™
pneumatiek

Hydrauliek

Snel-
koppelingen

Afsluiters

Roestvast
staal

Fittingen

Lucht-
conditionering

Gereedschap

Pneumatiek

Diversen

Malleabele
fittingen
& staal

Ringleiding-
systemen

Slangen

Compressoren

Compensator PN16 flensaansluiting - BS4504

Rubber compensatoren zijn ontworpen voor het opnemen van geluid, foutuitlijningen, leidinguitzetting of verzakkingen en trillingen in leidingen.

Voor veel toepassingen met verschillende media zoals water, olie, chemicaliën en gassen.

Temperatuur:
-30°C tot +110°C

Maximale werkdruk:
16 bar



NBR

0388	Flensmaat	DN	L mm	€
FRB-PN16-114NBR	1.1/4"	32	130	41.60
FRB-PN16-112NBR	1.1/2"	40	130	46.95
FRB-PN16-2NBR	2"	50	130	54.80
FRB-PN16-212NBR	2.1/2"	65	130	66.70
FRB-PN16-3NBR	3"	80	130	80.75
FRB-PN16-4NBR	4"	100	130	96.75
FRB-PN16-5NBR	5"	125	130	133.45
FRB-PN16-6NBR	6"	150	130	179.50
FRB-PN16-8NBR	8"	200	130	246.70
FRB-PN16-10NBR	10"	250	130	344.70
FRB-PN16-12NBR	12"	300	130	420.10

EPDM

0388	Flensmaat	DN	L mm	€
FRB-PN16-114EPDM	1.1/4"	32	130	41.60
FRB-PN16-112EPDM	1.1/2"	40	130	46.95
FRB-PN16-2EPDM	2"	50	130	54.80
FRB-PN16-212EPDM	2.1/2"	65	130	66.70
FRB-PN16-3EPDM	3"	80	130	80.75
FRB-PN16-4EPDM	4"	100	130	96.75
FRB-PN16-5EPDM	5"	125	130	133.45
FRB-PN16-6EPDM	6"	150	130	179.50
FRB-PN16-8EPDM	8"	200	130	246.70
FRB-PN16-10EPDM	10"	250	130	344.70
FRB-PN16-12EPDM	12"	300	130	420.10

Voor

draadflenzen, voorlasflenzen, vlakke lasflenzen en blindflenzen



...zie pagina 666

Leidingknippers

Leidingkniptang - metaal

Verchroomde metalen & kunststof leidingkniptangen met verwisselbare mesjes.
Een onmisbaar stuk gereedschap voor het snijden van PA, PE, PU, PPC, Vinylnyl, PVC en vele andere slangen.



Voor slang \varnothing 2-12 mm



27000216	Leidingkniptang	20.00
27010216	Vervangingsmes voor leidingkniptang 2-12mm	6.00

Voor slang \varnothing 4-28 mm



27000825	Leidingkniptang	28.90
27010825	Vervangingsmes voor leidingkniptang 4-28mm	9.00

Leidingknipper - kunststof

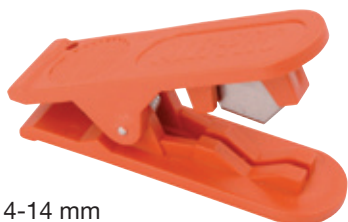

Voor slang \varnothing 4-14 mm



27000414	Leidingknipper	3.30
27010414	Vervangingsmes voor leidingknipper 4-14mm	2.70

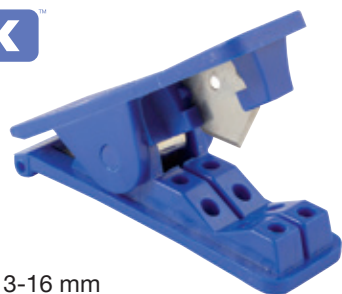

Voor slang \varnothing 3-16 mm



KTC-1	Blauw	3.05
-------	-------	------

Pijpsnijder



Voor slangen en buizen \varnothing 3-16 mm



CTC-2	8.95
-------	------



Voor slangen en buizen \varnothing 3-30 mm



CTC-1	8.05
-------	------



Voor slangen en PVC/PVR buizen \varnothing 6-35 mm



LBS-120	57.50
---------	-------

Bundelspiraal - zwart

Voor het bundelen en/of beschermen van slangen of kabels.



LDPE



28210604	5-20mm	50	Zwart	43.10
28210806	7-40mm	50	Zwart	50.20
28211209	11-60mm	50	Zwart	106.20

KELM™
pneumatiek

Hydrauliek

Snel-
koppelingen

Atsluiters

Roestvast
staal

Fittingen

Lucht-
conditionering

Gereedschap

Pneumatiek

Diversen

Malleabele
fittingen &
staal

Ringleiding-
systemen

Slangen

Compressoren

Staalomvlochten slang en accessoires



Nitriël rubber slang

De opgeven druk is gebaseerd op een temperatuur van 20°C

Temperatuur:
-20°C tot 80°C

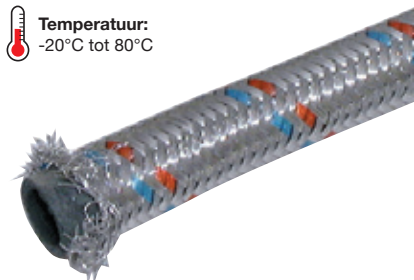

Gegalvaniseerde omvlechting -
30 meter rol



GOB-6	15	30	6	10	186.65
GOB-8	15	30	8	13	206.50
GOB-10	15	30	10	15	245.40
GOB-13	10	30	13	19	267.30

EPDM rubber slang

Temperatuur:
-20°C tot 100°C



RVS AISI-304 omvlechting -
30 meter rol



SOB-8	15	30	8	12	261.70
SOB-10	15	30	10	14	281.60
SOB-13	15	30	13	18	314.60
SOB-16	12	30	16	22	529.65
SOB-19	10	30	19	27	605.15
SOB-25	10	30	25	34	785.15

Slangfittingen

Inschroeffitting -
slangpilaar x
BSPT male
(tenzij anders
aangegeven)



EPDM	BSPP	ID mm	€
MC1/8-6	1/8"	6	3.25
MC1/4-6	1/4"	6	3.40
MC1/4-8	1/4"	8	3.20
MC3/8-8	3/8"	8	2.45
MC1/2-8	1/2" BSP	8	8.25
MC3/4-8	3/4" BSP	8	6.90
MC3/8-10	3/8"	10	2.30
MC1/2-10	1/2"	10	4.05
MC3/4-10	3/4" BSP	10	7.15
MC3/8-13	3/8"	13	2.60
MC1/2-13	1/2"	13	4.25
MC3/4-13	3/4"	13	7.50
MC1/2-16	1/2"	15	4.80
MC3/4-15	3/4" BSP	15	7.20
MC3/4-19	3/4"	19	7.60
MC1-25	1"	25	15.00

Opschroeffitting -
slangpilaar x
BSP female
bolconische dichting



EPDM	BSPP	ID mm	€
FO1/8-6	1/8"	6	4.05
FO1/4-6	1/4"	6	4.10
FO3/8-6	3/8"	6	6.00
FO1/4-8	1/4"	8	4.10
FO3/8-8	3/8"	8	2.85
FO3/8-10	3/8"	10	4.35
FO3/8-13	3/8"	13	4.40
FO1/2-13	1/2"	13	5.05
FO3/4-16	3/4"	16	8.20
FO3/4-19	3/4"	19	7.50
FO1-25	1"	25	10.70

Opschroeffitting -
slangpilaar x
BSP female vlakke
dichting (wordt
geleverd zonder O-ring)



EPDM	BSPP	ID mm	€
FP3/8-8BX	3/8"	8	2.70
FP1/2-8BX	1/2"	8	3.90
FP3/8-10BX	3/8"	10	2.40
FP1/2-10BX	1/2"	10	4.05
FP3/4-10BX	3/4"	10	5.70
FP3/8-13BX	3/8"	13	3.60
FP1/2-13BX	1/2"	13	4.15
FP3/4-13BX	3/4"	13	5.55
FP1/2-16BX	1/2"	16	5.50
FP3/4-16BX	3/4"	16	6.35
FP3/4-19BX	3/4"	19	7.25
FP1-19BX	1"	19	10.85
FP1-25BX	1"	25	11.80

O-ringen t.b.v. deze fittingen vindt u op pagina 735.



Messing vernikkeld

Opschroeffitting -
slangpilaar 90° knie
x BSP female vlakke dichting
(wordt geleverd zonder O-ring)



EPDM	BSPP	ID mm	€
FPN3/8-8	3/8"	8	6.85
FPN1/2-8	1/2"	8	10.35
FPN3/4-8	3/4"	8	11.95
FPN3/8-10	3/8"	10	9.10
FPN1/2-10	1/2"	10	9.30
FPN3/4-10	3/4"	10	13.35
FPN1/2-13	1/2"	13	10.35
FPN3/4-13	3/4"	13	11.65
FPN3/4-16	3/4"	16	16.75
FPN3/4-19	3/4"	19	18.05
FPN1-25	1"	25	34.90

O-ringen t.b.v. deze fittingen vindt u op pagina 735.

Opschroeffitting - slangpilaar 90° knie
x BSP female bolconische dichting



EPDM	BSPP	ID mm	€
FON1/4-6	1/4"	6	4.95
FON1/4-8	1/4"	8	5.05
FON3/8-8	3/8"	8	9.25
FON3/8-10	3/8"	10	9.55
FON1/2-13	1/2"	13	10.00
FON3/4-16	3/4"	16	12.40
FON3/4-19	3/4"	19	13.45
FON1-25	1"	25	32.90

Knelfitting - slangpilaar x knelring



EPDM	ID mm	OD mm	€
MB15-10BX	10	15	8.10
MB15-13BX	13	15	8.30
MB22-13BX	13	22	11.55
MB22-19BX	19	22	16.25

Staalomvloten slang en accessoires



Slangfittingen



Messing vernikkeld



Steenlippel - slangpilaar x steel



HCL8-6	6	8	messing vernikkeld	7.10
HCL10-8	8	10	blank messing	6.35
HCL10-10	10	10	messing vernikkeld	7.35
HCL10-12	10	12	blank messing	6.50
HCL12	12	12	blank messing	6.50
HCL12-15	12	15	blank messing	7.55
HCL22-19	19	22	blank messing	9.10

Dichtingsringen



Voor fittingen met vlakke dichting
t.b.v. omvloten slang



15-8-2MM	EPDM ring 8 x 2mm	3/8"	0.30
19-10-2MM	EPDM ring 10 x 2mm	1/2"	0.30
24-14-2MM	EPDM ring 14 x 2mm	3/4"	0.30
G12	Fiber ring 1/2"	1/2"	0.30
G1	Fiber ring 1"	1"	0.60
G112	Fiber ring 1.1/2"	1.1/2"	0.70
G2	Fiber ring 2"	2"	0.85

Krimphulzen

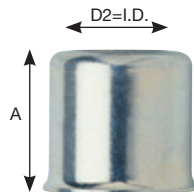

Zacht staal



SHF-10	10.1	20	7.5	0.95
SHF-12	12.1	20	8.5	0.75
SHF-13	13.1	20	8.8	0.80
SHF-14	14.1	20	11	0.80
SHF-15	15.1	20	12.5	1.10
SHF-16	16.1	20	12.5	1.10
SHF-17	17.1	20	14.5	1.10
SHF-18	18.1	20	14.5	2.65
SHF-19	19.1	21	14.8	1.80
SHF-20	20.1	22	14.8	1.80
SHF-28	28.1	32	20.5	3.00
SHF-33	33.1	34	26.5	3.40

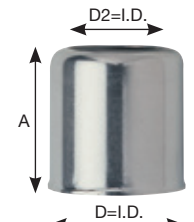

RVS AISI-303



STF-11	11.1	20	8.5	1.25
STF-12	12.1	20	8.5	2.65
STF-13	13.1	20	8.8	2.65
STF-14	14.1	20	11	2.70
STF-15	15.1	20	12.5	2.65
STF-17	17.1	20	14.5	2.85
STF-18	18.1	20	14.5	3.10
STF-22	22.1	22	15.5	3.85

Aluminium



B12X14	9	12	14	0.70
B13X15	9	13	15	0.70
B14X16	9,5	14	16	0.70
B16X18	12	16	18	0.70
B18X20	13	18	20	0.95
B20X22	15	20	22	0.95
B21X23	15	21	23	0.95
B23X25	17	23	25	3.15
B26X28	20	26	28	2.95
B28X30	19	28	30	3.15
B33X35	26	33	35	3.40
B36X38	26	36	38	3.85



RVS



B11X12SS	8	11	12	0.65
B13X14SS	9,3	13	14	1.00
B18X19SS	14	18,5	19,5	1.30
B15X16SS	11	15	16	1.85
B23X25SS	17	23	25	3.35
B29X30SS	21	29	30	4.70
B36X38SS	29	36	38	7.35

Vernikkeld staal



HS9X55	5,5	9	10	0.30
HS10X65	6,5	10	11	0.30
HS11X65	6,5	11	12	0.30
HS11X75	7,5	12	13	0.40
HS12X12	12	12,5	13,5	1.05
HS125X10	10	12,5	13,5	0.65
HS135X75	7,5	13,5	14,5	0.40
HS135X10	10	13,5	14,5	0.45
HS14X10	10	14	16	0.45
HS15X10	10	15	17	0.45
HS15X117	11,7	15	17	0.45
HS150X117	11,7	15	-	0.60
HS16X117	11,7	16	18	0.45
HS17X117	11,7	17	19	0.55
HS18X138	13,8	18	20	0.70
HS19X138	13,8	19	21	0.70
HS20X138	13,8	20	22	0.70
HS22X156	15,6	22	24	1.00
HS23X17	17	23	25	1.15
HS245X17	17	24,5	26,5	1.20
HS265X195	19,5	26,5	28,5	1.25
HS28X205	20,5	28	30	1.40
HS30X24	24	30	32	2.45
HS32X24	24	32	34	2.45
HS33X24	24	33	35	2.65
HS34X24	24	34	36	2.90
HS36X25	25	36	38	3.60
HS38X27	27	38	40	4.30
HS40X28	28	40	42	5.15
HS45X35	35	45	47	5.95

Slangenpers UPS1 (handpers)
op aanvraag leverbaar



Hoofdstuk 13 - Slangen

KELM™
pneumatiek

Hydrauliek

Snel-
koppelingen

Atsluiters

Roestvast
staal

Fittingen

Lucht-
conditionering

Gereedschap

Pneumatiek

Diversen

Malleabele
fittingen
& staal

Ringleiding-
systemen

Slangen

Compressoren

Slangenpers en persbekken

Geschikt voor het persen van 1/4" tot 3/8" ID slang met 1 of 2 lagen.
De pers heeft bevestigingsgaten voor permanente installatie of kan worden toegepast als draagbare eenheid.
Type HC50 (artikelnummer CV500) wordt geleverd met een standaard set van persbekken.



Persmaten I.D. ±:
1 – 0.630" (16mm)
2 – 0.580" (14.7mm)
3 – 0.530" (13.5mm)
4 – 0.480" (12.2mm)
5 – 0.680" (17.3mm)

Deze pers is alleen geschikt voor gebruik met tinnen/messing pershulzen.



Type HC50 - kleine doorlaat

Tech Data
10648

6720

CV500



124.20

Geschikt voor het persen van 1/2" tot 1" ID slang (7/8" tot 1.1/2" OD slang)
De pers wordt geleverd zonder persbekken, selecteer de juiste set uit onderstaande module.



Type HC51 - grote doorlaat

6720

CV501



127.80

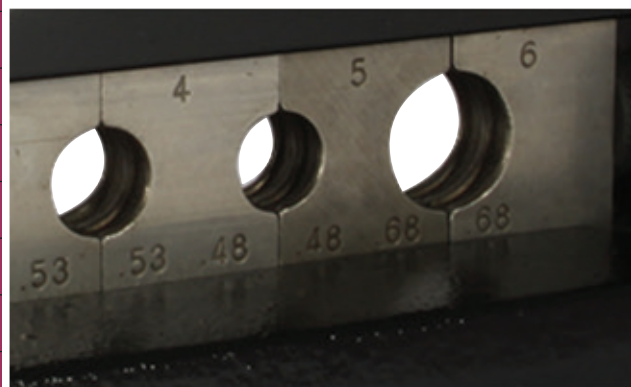

Persbekken voor type HC50

	6720	OD	OD mm	€
HC50-10		3/8"	9.53	30.05
HC50-7		7/16"	11.11	30.05
HC50-45		31/64"	12.30	12.25
HC50-34		17/32"	13.49	12.25
HC50-23		37/64"	14.68	12.25
HC50-12		5/8"	15.88	14.25
HC50-56		11/16"	17.46	16.65
HC50-8		3/4"	19.05	30.05
HC50-9		13/16"	20.64	30.05



Persbekken voor type HC51

	6720	OD	OD mm	€
HC51-22		11/16"	17.46	31.05
HC51-23		23/32"	18.26	31.05
HC51-24		3/4"	19.05	31.05
HC51-25		25/32"	19.84	31.05
HC51-26		13/16"	20.64	31.05
HC51-27		27/32"	21.43	31.05
HC51-28		7/8"	22.23	31.05
HC51-29		29/32"	23.02	31.05
HC51-30		15/16"	23.81	31.05
HC51-31		31/32"	24.61	31.05
HC51-32		1"	25.40	31.05
HC51-33		1.1/32"	26.19	31.05
HC51-34		1.1/16"	26.99	31.05
HC51-36		1.1/8"	28.58	31.05
HC51-38		1.3/16"	30.16	31.05
HC51-40		1.1/4"	31.75	30.40
HC51-42		1.5/16"	33.34	31.05
HC51-44		1.3/8"	34.93	31.05
HC51-46		1.7/16"	36.51	31.05
HC51-48		1.1/2"	38.10	31.05

Slangpilaren

**Schroefdraden:**

BSPT volgens ISO 7.1, BS 21,
DIN-2999
BSP volgens ISO 228, klasse A.

Media:

Perslucht, water, olie en
vloeistoffen in het algemeen
voor hydraulische en
pneumatische toepassingen.

Druk en temperatuur is volledig
afhankelijk van het type slang
dat wordt toegepast.

Om deze reden moeten de
waarden worden vastgesteld
in overeenstemming met de
kenmerken van de slang.

Tech Data 20089

Bestendigheid: standaard, niet geschikt voor: ammoniak, zuren, chloor ed.
Veiligheidsfactor: 3



Temperatuur:
 Indicatie: -20°C tot +400°C



Automaten
 messing MS-58



De opgegeven werkdruk is gebaseerd op een temperatuur van 20°C.
 Iedere temperatuurverhoging boven 20°C heeft effect op de druk/vacuüm bestendigheid.

Slangpilaren - blank messing

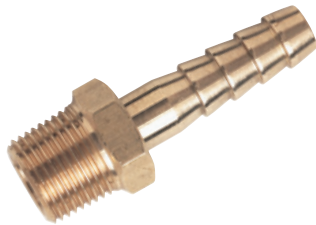

Slangpilaar inschroef - BSPT male

1010	To Suit Hose I.D. mm	BSPT	bar	€
GT10/04K	4	1/8"	200	1.15
GT10/05K	5	1/8"	200	1.15
GT10/06K	6	1/8"	200	0.90
GT10/08K	8	1/8"	200	1.45
GT10/09K	9	1/8"	200	1.45
GT13/04K	4	1/4"	150	1.70
GT13/05K	5	1/4"	150	1.50
GT13/06K	6	1/4"	150	0.90
GT13/08K	8	1/4"	150	1.15
GT13/09K	9	1/4"	150	1.20
GT13/13K	13	1/4"	150	1.70
GT17/06K	6	3/8"	100	2.10
GT17/08K	8	3/8"	100	1.90
GT17/09K	9	3/8"	100	2.10
GT17/13K	13	3/8"	100	2.15
GT17/16K	16	3/8"	100	2.85
GT17/19K	19	3/8"	100	5.20
GT21/06K	6	1/2"	100	2.30
GT21/08K	8	1/2"	100	2.35
GT21/09K	9	1/2"	100	2.50
GT21/13K	13	1/2"	100	2.95
GT21/16K	16	1/2"	100	3.35
GT21/19K	19	1/2"	100	3.60
GT21/25K	25	1/2"	100	7.55
GT26/09K	9	3/4"	100	4.15
GT26/13K	13	3/4"	100	3.90
GT26/16K	16	3/4"	100	4.70
GT26/19K	19	3/4"	100	4.50
GT26/25K	25	3/4"	100	6.55
GT33/13K	13	1"	100	7.45
GT33/19K	19	1"	100	7.25
GT33/25K	25	1"	100	7.60
GT33/31K	31	1"	100	9.20
GT42/25K	25	1.1/4"	100	11.55
GT42/31K	31	1.1/4"	100	14.10
GT48/38K	38	1.1/2"	100	21.40
GT52/50K	50	2"	100	28.20

Slangpilaren - messing vernikkeld



Slangpilaar inschroef - BSPT male

1011	To Suit Hose I.D.	BSPT	€
GT10/04KNP	4	1/8"	1.50
GT10/05KNP	5	1/8"	1.50
GT10/06KNP	6	1/8"	1.20
GT10/08KNP	8	1/8"	1.95
GT10/09KNP	9	1/8"	1.95
GT13/04KNP	4	1/4"	2.30
GT13/05KNP	5	1/4"	2.05
GT13/06KNP	6	1/4"	1.20
GT13/08KNP	8	1/4"	1.50
GT13/09KNP	9	1/4"	1.70
GT13/13KNP	13	1/4"	2.30
GT17/06KNP	6	3/8"	2.90
GT17/08KNP	8	3/8"	2.50
GT17/09KNP	9	3/8"	2.90
GT17/13KNP	13	3/8"	2.95
GT17/16KNP	16	3/8"	3.85
GT17/19KNP	19	3/8"	7.10
GT21/06KNP	6	1/2"	3.10
GT21/08KNP	8	1/2"	4.70
GT21/09KNP	9	1/2"	3.35
GT21/13KNP	13	1/2"	4.05
GT21/16KNP	16	1/2"	4.70
GT21/19KNP	19	1/2"	4.95
GT21/25KNP	25	1/2"	10.35
GT26/09KNP	9	3/4"	5.60
GT26/13KNP	13	3/4"	5.25
GT26/16KNP	16	3/4"	6.45
GT26/19KNP	19	3/4"	6.05
GT26/25KNP	25	3/4"	8.90
GT33/13KNP	13	1"	10.25
GT33/19KNP	19	1"	9.85
GT33/25KNP	25	1"	10.35
GT33/31KNP	31	1"	12.55
GT42/25KNP	25	1.1/4"	15.75
GT42/31KNP	31	1.1/4"	19.25
GT48/38KNP	38	1.1/2"	29.15
GT52/50KNP	50	2"	38.40

Slangpilaren



Slangpilaren - blank messing

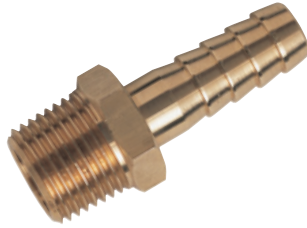

Slangpilaar inschroef - NPTF male

1010	To Suit Hose I.D. mm	NPTF	€
650-1004	4	1/8"	2.95
650-1005	5	1/8"	1.85
650-1006	6	1/8"	1.85
650-1305	5	1/4"	2.05
650-1306	6	1/4"	2.20
650-1308	8	1/4"	2.50
650-1310	10	1/4"	2.80
650-1706	6	3/8"	4.40
650-1710	10	3/8"	4.80
650-1713	13	3/8"	5.40
650-2110	10	1/2"	10.25
650-2113	13	1/2"	10.25

Tech Data
20348



Tee slangpilaar

1010	To Suit Hose I.D. mm	bar	€
THT-5	5	100	4.00
THT-6	6	100	4.00
THT-8	8	100	2.65
THT-10	10	50	3.85
THT-13	13	50	6.35

Tech Data
20349



Haakse slangpilaar inschroef - BSPT male

1010	To Suit Hose I.D. mm	BSPT	bar	€
EHT-18-6	6	1/8"	100	3.70
EHT-18-8	8	1/8"	100	3.70
EHT-18-10	10	1/8"	100	3.70
EHT-14-6	6	1/4"	100	3.85
EHT-14-8	8	1/4"	100	3.70
EHT-14-10	10	1/4"	100	3.70
EHT-14-13	13	1/4"	100	8.40
EHT-38-6	6	3/8"	100	4.85
EHT-38-8	8	3/8"	100	4.85
EHT-38-10	10	3/8"	100	4.55
EHT-38-13	13	3/8"	100	7.60
EHT-12-8	8	1/2"	100	8.40
EHT-12-10	10	1/2"	100	8.80
EHT-12-13	13	1/2"	100	8.90



Verbindingslangpilaar

1010	To Suit Hose I.D. mm	€
40310505	5	1.40
40310606	6	1.35
40310808	8	1.65
40310909	9	1.80
40311313	13	2.10
40311616	16	2.45
40311919	19	3.55
40312525	25	8.20



Y-slangpilaar

1010	To Suit Hose I.D.	€
2020-1943	1/4" (6.5mm)	5.05
2020-1950	5/16" (9mm)	5.50
2020-1968	3/8" (11mm)	7.25
2020-1976	1/2" (14mm)	12.55

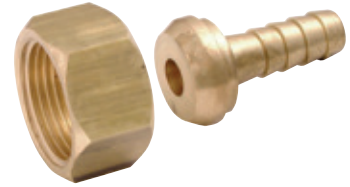

Slangpilaar opschroef met wartel - BSP female 60° bolconus

1010	To Suit Hose I.D. mm	BSPP	bar	€
FH10/18	4	1/8"	100	1.20
FH13/14	6	1/4"	100	2.20
FH13/516	8	1/4"	100	2.20
FH13/38	10	1/4"	100	2.30
FH17/14	6	3/8"	75	2.85
FH17/516	8	3/8"	75	3.05
FH17/38	10	3/8"	75	3.15
FH17/12	13	3/8"	75	2.45
FH21/38	10	1/2"	75	3.65
FH21/12	13	1/2"	75	3.75
FH26/34	19	3/4"	75	6.40
FH33/1	25	1"	70	8.65



Slangpilaar opschroef met wartel - BSP female met vlakke dichting en dichtingsring

1010	To Suit Hose I.D. mm	BSPP	bar	€
FH13/316FF	5	1/4"	40	1.35
FH13/14FF	6	1/4"	40	1.50
FH13/516FF	8	1/4"	40	1.65
FH13/38FF	10	1/4"	40	2.00
FH17/14FF	6	3/8"	40	2.05
FH17/38FF	10	3/8"	40	2.45
FH17/12FF	13	3/8"	40	2.45
FH21/38FF	10	1/2"	40	2.70
FH21/12FF	13	1/2"	40	4.40
FH26/34FF	19	3/4"	40	6.60
FH33/1FF	25	1"	30	10.30

Hoofdstuk 13 - Slangen

KELM™
pneumatiek

Hydrauliek

Snel-
koppelingen

Atsluiters

Roestvast
staal

Fittingen

Lucht-
conditioning

Gereedschap

Pneumatiek

Diversen

Malleabele
fittingen
& staal

Ringleiding-
systemen

Slangen

Compressoren

Slangpilaren

Slangpilaren mini - blank messing

Zeer geschikt voor besturingspanelen, logische besturing en minipneumatiek.

Schroefdraad: metrisch volgens ISO R/262.

Toepassing: perslucht. Gebruik deze pilaren in combinatie met flexibele slangen zoals PU.

De slang wordt door de vorm van de pilaar direct vastgehouden, hierdoor is het gebruik van slangklemmen niet nodig.

Tech Data
983

Temperatuur: -10°C tot 80°C

Maximale werkdruk: -0.99 bar tot 10 bar



Slangpilaar inschroef - metrisch male

1010	To Suit Hose I.D. mm		€
41190305	3	M5	1.10
41190405	4	M5	1.10



Verbindings slangpilaar

1010	To Suit Hose I.D. mm	L mm	€
41310202	2 x 2	20	1.65
41310303	3 x 3	20	1.65
41310404	4 x 4	22	1.85
41310606	6 x 6	22	1.85
41310302	3 x 2	20	1.65
41310403	4 x 3	21	1.85
41310604	6 x 4	22	1.85

Slangpilaren - messing vernikkeld

Veiligheidsfactor 4



Maximale werkdruk:

Max. druk bij 20°C:

1/8" = 150 bar

1/4" = 100 bar

3/8" = 75 bar

1/2" = 50 bar

3/4" = 85 bar

1" = 80 bar



Messing vernikkeld MS-58, UNI-5705 stroomloos vernikkeld in- en uitwendig.



Slangpilaar opschroef - BSP female

1011	To Suit Hose I.D. mm	BSPF		€
40200610	6	1/8"	19 14	1.65
40200710	7	1/8"	19 14	1.65
40200713	7	1/4"	19 17	1.75
40200813	8	1/4"	19 17	1.95
40200913	9	1/4"	19 17	1.95
40200917	9	3/8"	19 20	2.50
40201017	10	3/8"	19 20	2.50
40201217	12	3/8"	20 20	2.50
40201221	12	1/2"	20 24	3.40



Slangpilaar inschroef - BSP male

1011	To Suit Hose I.D. mm	BSPM		€
40390710	7	1/8"	20 14	1.20
40390713	7	1/4"	20 17	1.65
40390810	8	1/8"	20 14	1.35
40390910	9	1/8"	20 14	1.35
40390913	9	1/4"	20 17	1.75
40390917	9	3/8"	20 19	2.15
40391213	12	1/4"	20 17	1.75
40391217	12	3/8"	20 19	2.15
40391221	12	1/2"	22 24	3.20
40391717	17	3/8"	24 19	2.40
40391721	17	1/2"	24 24	3.40

KELM™ pneumatiek

Hydrauliek

Snelkoppelingen

Afsluiters

Roestvast staal

Fittingen

Luchtconditionering

Gereedschap

Pneumatiek

Diversen

Malleabele fittingen & staal

Ringleidingssystemen

Slangen

Compressoren

Haakse slangpilaar

1010	To Suit Hose I.D. mm	€
41020202	2	2.90
41020303	3	2.90
41020404	4	3.30
41020606	6	3.30

Tee slangpilaar

1010	To Suit Hose I.D. mm	€
41030202	2	3.65
41030303	3	3.65
41030404	4	3.85
41030606	6	3.85

Slangpilaar inschroef - BSPT male

1011	To Suit Hose I.D. mm				€
40190405	4	M5	15	8	0.85
40190610	6	1/8"	20	12	1.10
40190613	6	1/4"	20	14	1.35
40190710	7	1/8"	20	12	1.10
40190713	7	1/4"	20	14	1.35
40190810	8	1/8"	20	12	1.20
40190813	8	1/4"	20	14	1.45
40190910	9	1/8"	20	12	1.20
40190913	9	1/4"	20	14	1.50
40190917	9	3/8"	20	17	2.15
40190921	9	1/2"	20	22	2.65
40191010	10	1/8"	20	12	1.45
40191013	10	1/4"	20	14	1.50
40191017	10	3/8"	20	17	2.15
40191021	10	1/2"	20	22	2.70
40191213	12	1/4"	20	14	1.50
40191217	12	3/8"	20	17	2.15
40191221	12	1/2"	20	22	2.70
40191417	14	3/8"	20	17	2.50
40191421	14	1/2"	20	22	2.80
40191617	16	3/8"	20	17	2.65
40191621	16	1/2"	20	22	3.00
40191627	16	3/4"	20	27	4.55
40191717	17	3/8"	20	19	2.70
40191721	17	1/2"	20	22	3.20
40191817	18	3/8"	20	19	3.30
40191821	18	1/2"	20	22	3.40
40191827	20	3/4"	20	27	4.75
40192017	20	3/8"	20	21	3.15
40192021	20	1/2"	20	22	3.20
40192027	20	3/4"	20	27	4.40
40192527	25	3/4"	20	27	4.55
40192532	25	1"	30	34	7.15

Slangpilaren



Slangpilaren - staal verzinkt

Temperatuur: -50°C to +120°C
Barstdruk: 135 bar



Slangpilaar inschroef - BSPT male - heavy duty

1011	To Suit Hose I.D.	BSPT	€
625000	3/16" (5mm)	1/8"	4.75
625002	3/16" (5mm)	1/4"	3.10
625020	1/4" (6mm)	1/8"	1.85
625022	1/4" (6mm)	1/4"	2.45
625024	1/4" (6mm)	3/8"	3.95
625025	1/4" (6mm)	1/2"	5.45
625032	5/16" (8mm)	1/4"	2.45
625034	5/16" (8mm)	3/8"	3.90
625035	5/16" (8mm)	1/2"	5.80
625042	3/8" (10mm)	1/4"	2.45
625044	3/8" (10mm)	3/8"	3.90
625045	3/8" (10mm)	1/2"	5.55
625052	1/2" (13mm)	1/4"	3.25
625054	1/2" (13mm)	3/8"	6.35
625055	1/2" (13mm)	1/2"	7.20
625057	1/2" (13mm)	3/4"	10.90
625074	3/4" (20mm)	3/8"	8.25
625077	3/4" (20mm)	3/4"	14.80

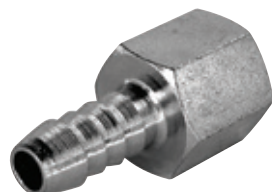

Slangpilaar opschroef - BSP female - heavy duty

1011	To Suit Hose I.D.	BSPT	€
626020	1/4" (6mm)	1/8"	3.15
626022	1/4" (6mm)	1/4"	3.95
626024	1/4" (6mm)	3/8"	4.65
626032	5/16" (8mm)	1/4"	3.45
626042	3/8" (10mm)	1/4"	4.00
626044	3/8" (10mm)	3/8"	5.40
626045	3/8" (10mm)	1/2"	8.70
626052	1/2" (13mm)	1/4"	4.85
626054	1/2" (13mm)	3/8"	5.35
626055	1/2" (13mm)	1/2"	8.50



Slangpilaren - staal vernikkeld

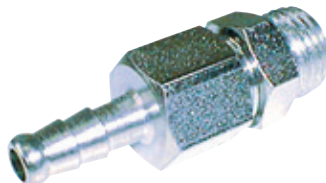

Slangpilaar inschroef - draaibaar - BSPT male

1011	To Suit Hose I.D. mm	BSPT	€
40400713	7	1/4"	5.30
40400717	7	3/8"	6.15
40400917	9	3/8"	6.35
40401113	11	1/4"	5.30
40401117	11	3/8"	6.35
40401417	14	3/8"	6.15



Slangpilaar inschroef - BSPT male

1011	To Suit Hose I.D. mm	BSPT	€
CNS-12	13	1/2"	3.00
CNS-34	19	3/4"	3.20
CNS-1	25	1"	4.90
CNS-114	32	1.1/4"	5.85
CNS-112	38	1.1/2"	7.55
CNS-2	50	2"	11.00
CNS-212	62	2.1/2"	14.35
CNS-3	76	3"	18.60
CNS-4	100	4"	31.75
CNS-5	126	5"	77.35
CNS-6	150	6"	90.80



Verbindingsslangpilaar

1011	To Suit Hose I.D. mm	€
40310707	7	1.95
40310909S	9	2.05
40311111	11	2.75



Verbindingsslangpilaar

1011	To Suit Hose I.D. mm	€
SHM-12	13	2.70
SHM-34	19	3.60
SHM-1	25	4.90
SHM-114	32	4.90
SHM-112	38	6.10
SHM-2	50	13.70
SHM-212	62	15.40
SHM-3	76	22.10
SHM-4	100	34.70
SHM-5	126	87.05
SHM-6	150	174.30

KELM™
pneumatiek

Hydrauliek

Snel-
koppelingen

Atsluiters

Roestvast
staal

Fittingen

Lucht-
conditionering

Gereedschap

Pneumatiek

Diversen

Malleabele
fittingen
& staal

Ringleiding-
systemen

Slangen

Compressoren

Slangpilaren - aluminium met messing buitenlaag

Draadtype:

Conisch volgens ISO 7.1 / BS 21 / DIN2999.

Toepassing:

Perslucht, water, olie en vloeistoffen in het algemeen op pneumatisch gebied.

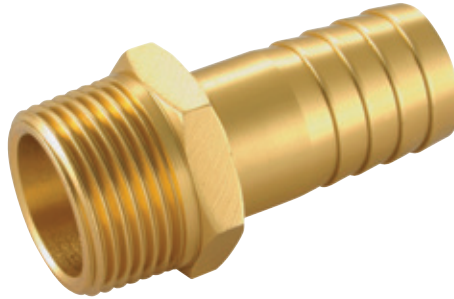

Temperatuur: 0°C tot +80°C
 Maximale werkdruk: 10 bar

Slangpilaar inschroef - BSPT male

1010	To Suit Hose I.D. mm	BSPT	€
AGT13/06K	6	1/4"	0.65
AGT13/08K	8	1/4"	0.55
AGT13/09K	9	1/4"	0.65
AGT13/13K	13	1/4"	0.75
AGT17/09K	9	3/8"	0.90
AGT17/13K	13	3/8"	0.80
AGT21/13K	13	1/2"	1.40
AGT21/19K	19	1/2"	1.40
AGT26/19K	19	3/4"	2.40
AGT33/25K	25	1"	4.90

“EEN ALTERNATIEF VOOR MESSING”

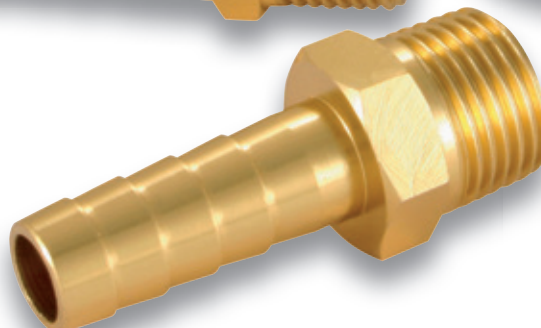
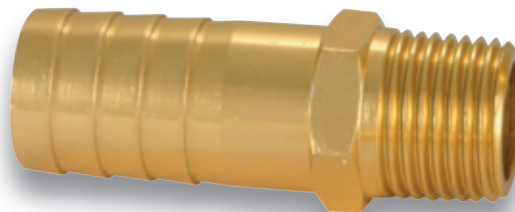

- Een nieuw begrip qua ontwerp, lichtgewicht pilaren met hoogwaardige en sterke eigenschappen.
- BSPT draad conform ISO 7.1, BS 21, DIN 2999.
- Voor gebruik met perslucht, water, olie en vloeistoffen in het algemeen op pneumatisch gebied.
- Heeft het uiterlijk van messing.

Druk en temperatuur is volledig afhankelijk van het type slang dat wordt toegepast.

Om deze reden moeten de waarden worden vastgesteld in overeenstemming met de kenmerken van de slang.

KELM™
pneumatiek

Hydrauliek

Snel-
koppelingen

Afsluiters

Roestvast
staal

Fittingen

Lucht-
conditionering

Gereedschap

Pneumatiek

Diversen

Malleabele
fittingen
& staal

Ringleiding-
systemen

Slangen

Compressoren

Slangpilaren



Hoogwaardige industriële kwaliteit.

Normering: BSPT-Conische schroefdraad, BS21;ISO 7.1; DIN-2999, BSP-Parallel schroefdraad, BS2779;ISO 228.

Veiligheidsfactor: 4

Temperatuur:
-20°C tot 290°C

Maximale werkdruk:
10 bar



Slangpilaren hogedruk - RVS AISI-316L

Temperatuur:
tot 225°C

Maximale werkdruk:
tot 140 bar

Slangpilaren - RVS AISI-316

Tech Data
1795



Slangpilaar inschroef - BSPT male

RVSK	To Suit Hose I.D. mm	BSPT	€
HT-18	4	1/8"	3.85
HT-18-6	6	1/8"	3.75
HT-14	6	1/4"	4.60
HT-14-08	8	1/4"	4.35
HT-14-10	10	1/4"	4.80
HT-14-13	13	1/4"	4.65
HT-38-08	8	3/8"	5.75
HT-38	10	3/8"	5.75
HT-38-13	13	3/8"	6.40
HT-12-10	10	1/2"	9.90
HT-12	13	1/2"	10.50
HT-12-19	19	1/2"	10.90
HT-12-25	25	1/2"	15.55
HT-34-13	13	3/4"	13.40
HT-34	19	3/4"	15.30
HT-1-19	19	1"	26.85
HT-1	25	1"	20.40
HT-1-31	31	1"	24.15
HT-114	31	1.1/4"	15.00
HT-112	38	1.1/2"	22.75
HT-2	50	2"	34.85
HT-212	63	2.1/2"	52.05
HT-3	75	3"	65.30
HT-4	100	4"	134.65

Tech Data
2077



Slangpilaar opschroef - BSP female

RVSK	To Suit Hose I.D. mm	BSPP	€
SFHT10/06	6	1/8"	8.35
SFHT13/06	6	1/4"	9.80
SFHT13/09	9	1/4"	9.80
SFHT17/10	10	3/8"	11.90
SFHT21/13	13	1/2"	15.45
SFHT26/19	19	3/4"	18.90
SFHT33/25	25	1"	23.00
SFHT42/32	32	1.1/4"	30.10
SFHT48/38	38	1.1/2"	47.90
SFHT52/51	51	2"	60.70

Tech Data
20779



Slangpilaar opschroef met wartel - BSP female 60° bolconus

RVSK	To Suit Hose I.D. mm	BSPP	€
FH13/14SS	6	1/4"	5.50
FH17/38SS	10	3/8"	8.60
FH21/12SS	13	1/2"	11.75
FH26/34SS	19	3/4"	16.60

Tech Data
20778



Verbindingslangpilaar

RVSK	To Suit Hose I.D. mm	€
DS06-SS	6	3.95
DS08-SS	8	4.35
DS10-SS	10	4.65
DS13-SS	13	5.30

Combi slangpilaar inschroef - BSPT male

RVSK	BSPT	€
SCN-12	1/2"	23.00
SCN-34	3/4"	23.20
SCN-1	1"	26.25
SCN-114	1.1/4"	31.65
SCN-112	1.1/2"	39.90
SCN-2	2"	47.10
SCN-3	3"	123.10



Slangpilaar inschroef - BSPT male - dikwandig gedraaid

RVSD	To Suit Hose I.D. mm	BSPT	mm	mm	H mm	€
60190610	6	1/8"	19.5	11	32	8.10
60190710	7	1/8"	19.5	11	32	8.15
60190713	7	1/4"	19.5	14	35.5	10.00
60190813	8	1/4"	19.5	14	35.5	9.90
60190913	9	1/4"	19.5	14	35.5	10.00
60190917	9	3/8"	19.5	17	36	12.90
60191013	10	1/4"	19.5	14	35.5	9.90
60191017	10	3/8"	19.5	17	36	12.90
60191021	10	1/2"	19.5	22	39	16.05
60191213	12	1/4"	19.5	14	39	19.10
60191217	12	3/8"	19.5	17	36	11.30
60191221	12	1/2"	19.5	22	39	19.10
60191417	14	3/8"	19.5	17	36	12.65
60191421	14	1/2"	19.5	22	39	19.10
60191621	16	1/2"	19.5	22	39	19.25
60191821	18	1/2"	19.5	22	39	19.50
60191827	18	3/4"	19.5	27	43.5	27.50
60192021	20	1/2"	19.5	22	39	20.20
60192027	20	3/4"	19.5	27	40	27.50

KELM™
pneumatiek

Hydrauliek

Snel-
koppelingen

Atsluiters

Roestvast
staal

Fittingen

Lucht-
conditionering

Gereedschap

Pneumatiek

Diversen

Malleabele
fittingen
& staal

Ringleiding-
systemen

Slangen

Compressoren

Slangpilaren



Temperatuur:
-20°C tot 110°C

Maximale
werkdruk:
14 bar

Nylon 66

Slangpilaren - kunststof Nylon 66



Slangpilaar inschroef - BSPT male

KDR	To Suit Hose I.D. mm	BSPT	€
83190410	4	1/8"	0.70
83190413	4	1/4"	0.70
83190510	5	1/8"	0.70
83190513	5	1/4"	0.70
83190610	6	1/8"	0.70
83190613	6	1/4"	0.85
83190617	6	3/8"	0.80
83190621	6	1/2"	0.85
83190627	6	3/4"	0.85
83190810	8	1/8"	0.90
83190813	8	1/4"	1.00
83190817	8	3/8"	1.00
83190821	8	1/2"	1.00
83190827	8	3/4"	1.00
83191013	10	1/4"	1.10
83191017	10	3/8"	1.20
83191021	10	1/2"	1.20
83191027	10	3/4"	1.20
83191213	12	1/4"	1.20
83191217	12	3/8"	1.20
83191221	12	1/2"	1.20
83191227	12	3/4"	1.20
83191417	14	3/8"	1.20
83191421	14	1/2"	1.20
83191427	14	3/4"	1.20
83191621	16	1/2"	1.20
83191627	16	3/4"	1.55
83191921	19	1/2"	1.55
83191927	19	3/4"	1.55
83191932	19	1"	1.55
83192527	25	3/4"	1.75
83192532	25	1"	1.85



Slangpilaar inschroef - BSPT male - paneelmontage

KDR	To Suit Hose I.D. mm	BSPT	€
83201021	10	1/2"	1.55



Slangpilaar opschroef - BSPT female

KDR	To Suit Hose I.D. mm	BSPT	€
83210510	5	1/8"	0.75
83210513	5	1/4"	0.75
83211517	5	3/8"	0.75
83210521	5	1/2"	0.80
83210610	6	1/8"	0.60
83210613	6	1/4"	0.75
83211617	6	3/8"	0.75
83210621	6	1/2"	0.80
83210810	8	1/8"	0.75
83210813	8	1/4"	0.80
83210817	8	3/8"	0.85
83210821	8	1/2"	0.90
83211013	10	1/4"	0.85
83211017	10	3/8"	0.90
83211021	10	1/2"	0.90
83211213	12	1/4"	0.90
83211217	12	3/8"	0.90
83211221	12	1/2"	1.00
83211417	14	3/8"	0.90
83211421	14	1/2"	1.00
83211621	16	1/2"	1.10
83211921	19	1/2"	1.10



Slangpilaar opschroef met wartel - BSPT female

KDR	To Suit Hose I.D. mm	BSPT	€
83330410	4	1/8"	1.85
83330413	4	1/4"	1.85
83330510	5	1/8"	1.75
83330513	5	1/4"	1.75
83330517	5	3/8"	1.85
83330613	6	1/4"	1.75
83330617	6	3/8"	2.25
83330621	6	1/2"	2.25
83330813	8	1/4"	1.85
83330817	8	3/8"	2.05
83330821	8	1/2"	2.40
83330827	8	3/4"	2.30
83331017	10	3/8"	2.40
83331021	10	1/2"	3.15
83331027	10	3/4"	2.40
83331221	12	1/2"	2.25
83331227	12	3/4"	2.60
83331421	14	1/2"	3.25
83331427	14	3/4"	3.60
83331627	16	3/4"	3.70
83331927	19	3/4"	2.65



Verbindingsslangpilaar

KDR	To Suit Hose I.D. mm	€
83310404	4	0.70
83330505	5	0.60
83310606	6	0.70
83310808	8	0.70
83311010	10	0.80
83311212	12	0.85
83311414	14	0.90
83311616	16	1.00
83311919	19	1.10



Verbindingsslangpilaar - verlopend

KDR	To Suit Hose I.D. mm	€
83320504	5 - 4	0.70
83320604	6 - 4	0.70
83320605	6 - 5	0.75
83320805	8 - 5	0.75
83320806	8 - 6	0.80
83321006	10 - 6	0.85
83321008	10 - 8	0.90
83321208	12 - 10	1.00
83321210	12 - 10	1.10
83321410	14 - 10	1.10
83321412	14 - 12	1.20
83321612	16 - 12	1.20
83321614	16 - 14	1.45
83321914	19 - 14	1.45
83321916	19 - 16	1.45

KELM™ pneumatiek
Hydrauliek
Snel- koppelingen
Afsluiters
Roestvast staal
Fittingen
Lucht- conditionering
Gereedschap
Pneumatiek
Diversen
Malleabele fittings & staal
Ringleiding- systemen
Slangen
Compressoren

Slangpilaren - kunststof Nylon 66



Haakse slangpilaar inschroef - BSPT male

KDR	To Suit Hose I.D. mm	BSPT	€
83500410	4	1/8"	0.85
83500413	4	1/4"	0.90
83500510	5	1/8"	0.85
83500513	5	1/4"	0.90
83500521	5	1/2"	0.85
83500610	6	1/8"	0.85
83500613	6	1/4"	1.00
83500617	6	3/8"	1.10
83500621	6	1/2"	1.10
83500810	8	1/8"	1.20
83500813	8	1/4"	1.20
83500817	8	3/8"	1.20
83500821	8	1/2"	1.20
83501013	10	1/4"	1.20
83501017	10	3/8"	1.20
83501021	10	1/2"	1.45
83501027	10	3/4"	1.20
83501213	12	1/4"	1.45
83501217	12	3/8"	1.45
83501221	12	1/2"	1.55
83501227	12	3/4"	1.20
83501417	14	3/8"	1.55
83501421	14	1/2"	1.20
83501427	14	3/4"	1.20
83501621	16	1/2"	1.85
83501627	16	3/4"	1.85
83501921	19	1/2"	1.95
83501927	19	3/4"	2.00



Haakse slangpilaar

KDR	To Suit Hose I.D. mm	€
83340400	4	0.60
83340500	5	0.75
83340600	6	0.75
83340800	8	0.80
83341000	10	0.90
83341200	12	0.90
83341400	14	1.10
83341600	16	1.20
83341900	19	1.35



Haakse slangpilaar - verlopend

KDR	To Suit Hose I.D. mm	€
83350504	5 - 4	0.75
83350605	6 - 5	0.75
83350806	8 - 6	0.80
83351006	10 - 6	0.85
83351008	10 - 8	0.85
83351210	12 - 10	0.90
83351412	14 - 12	1.10
83351614	16 - 14	1.10
83351916	19 - 16	1.20



Tee slangpilaar inschroef - BSPT male

KDR	To Suit Hose I.D. mm	BSPT	€
83530410	4	1/8"	0.70
83530413	4	1/4"	0.80
83530510	5	1/8"	0.70
83530513	5	1/4"	0.80
83530610	6	1/8"	0.80
83530613	6	1/4"	0.85
83530617	6	3/8"	0.90
83530621	6	1/2"	1.00
83530810	8	1/8"	1.20
83530813	8	1/4"	1.20
83530817	8	3/8"	1.20
83530821	8	1/2"	1.20
83531013	10	1/4"	1.45
83531017	10	3/8"	1.45
83531021	10	1/2"	1.55
83531027	10	3/4"	1.45
83531213	12	1/4"	1.45
83531217	12	3/8"	1.45
83531221	12	1/2"	1.55
83531227	12	3/4"	1.45
83531417	14	3/8"	1.55
83531421	14	1/2"	1.75
83531427	14	3/4"	1.45
83531621	16	1/2"	1.85
83531627	16	3/4"	1.95
83531921	19	1/2"	2.00
83531927	19	3/4"	2.15



Tee slangpilaar

KDR	To Suit Hose I.D. mm	€
83540400	4	0.70
83540500	5	0.80
83540600	6	1.00
83540800	8	1.20
83541000	10	1.20
83541200	12	1.45
83541400	14	1.45
83541600	16	1.65
83541900	19	1.95



Tee slangpilaar - verlopend

KDR	To Suit Hose I.D. mm	€
83550504	5 - 4	0.85
83550605	6 - 5	0.90
83550806	8 - 6	1.20
83551008	10 - 8	1.20
83551210	12 - 10	1.20
83551412	14 - 12	1.45
83551614	16 - 14	1.95
83551916	19 - 16	2.05



Y-slangpilaar

KDR	To Suit Hose I.D. mm	€
83570400	4	1.00
83570600	6	1.00
83570800	8	1.20
83571000	10	1.65
83571700	17	1.95

Slangpilaren

Slangpilaren - kunststof Nylon 6

Temperatuur:
-40°C – 90°C

Maximale werkdruk:
1 – 10 bar

Nylon 6



Slangpilaar inschroef - BSPT male

NORM	BSPT	ID mm	€
GES4R18	1/8"	4	0.70
GES4R14	1/4"	4	1.00
GES5R14	1/4"	5	2.45
GES6R18	1/8"	6	0.95
GES6R14	1/4"	6	1.00
GES6R38	3/8"	6	1.40
GES8R18	1/8"	8	1.25
GES8R14	1/4"	8	1.25
GES8R38	3/8"	8	1.50
GES8R12	1/2"	8	2.20
GES10R14	1/4"	10	1.40
GES10R38	3/8"	10	1.50
GES12R38	3/8"	12	1.50
GES12R12	1/2"	12	2.20
GES14R38	3/8"	14	1.90
GES14R12	1/2"	14	2.35
GES16R12	1/2"	16	2.80
GES16R34	3/4"	16	2.80
GES19R34	3/4"	19	3.20
GES25R1	1"	25	3.55



Inschroefdop - BSPT male

NORM	BSPT	€
BSTR18	1/8"	0.50
BSTR14	1/4"	0.60
BSTR38	3/8"	1.15
BSTR12	1/2"	1.80



Tee slangpilaar inschroef - BSPT male

NORM	BSPT	ID mm	€
TES4R18	1/8"	4	0.95
TES4R14	1/4"	4	1.25
TES6R18	1/8"	6	1.15
TES6R14	1/4"	6	1.40
TES8R14	1/4"	8	1.70
TES10R38	3/8"	10	2.30



Haakse slangpilaar inschroef - BSPT male

NORM	BSPT	ID mm	€
WES4R18	1/8"	4	0.85
WES4R14	1/4"	4	1.15
WES6R18	1/8"	6	1.00
WES6R14	1/4"	6	1.25
WES6R38	3/8"	6	1.50
WES8R18	1/8"	8	1.50
WES8R14	1/4"	8	1.50
WES8R38	3/8"	8	1.80
WES8R12	1/2"	8	2.70
WES10R14	1/4"	10	1.90
WES10R38	3/8"	10	2.05
WES12R38	3/8"	12	2.30
WES12R12	1/2"	12	2.65
WES19R34	3/4"	19	3.20
WES25R1	1"	25	4.55

Slangpilaren - kunststof POM

Temperatuur:
-40°C - 80°C

Maximale
werkdruk:
1 - 10 bar

POM



Verbindings slangpielaar

NORM	ID. (mm)	€
NOR-GS3	3	0.30
NOR-GS4	4	0.30
NOR-GS5	5	0.50
NOR-GS6	6	0.65
NOR-GS8	8	0.90
NOR-GS10	10	1.15
NOR-GS12	12	1.70
NOR-GS13	13	1.70
NOR-GS14	14	2.05
NOR-GS16	16	2.35
NOR-GS19	19	2.70
NOR-GS25	25	4.55



Verbindings slangpielaar - verlopemd

NORM	ID. (mm)	€
GRS4-3	4-3	0.65
GRS6-4	6-4	0.70
GRS8-4	8-4	0.95
GRS8-6	8-6	1.25
GRS10-6	10-6	1.50
GRS10-8	10-8	1.50
GRS12-8	12-8	1.80
GRS12-10	12-10	1.80



Tee slangpielaar

NORM	ID. (mm)	€
NOR-TS3	3	0.55
NOR-TS4	4	0.65
NOR-TS5	5	0.85
NOR-TS6	6	0.95
NOR-TS7	7	1.15
NOR-TS8	8	1.40
NOR-TS10	10	1.80
NOR-TS12	12	2.20
NOR-TS13	13	2.65
NOR-TS14	14	2.65
NOR-TS15	15	3.10
NOR-TS16	16	3.55
NOR-TS19	19	3.95
NOR-TS25	25	5.50



Tee slangpielaar - verlopemd

NORM	ID. (mm)	€
TRS3-4-3	3-4-3	0.95
TRS4-6-4	4-6-4	0.95
TRS6-4-6	6-4-6	0.95
TRS8-4-8	8-4-8	1.40
TRS8-6-8	8-6-8	1.40
TRS10-6-10	10-6-10	1.80
TRS10-8-10	10-8-10	1.90
TRS10-13-10	10-13-10	2.20
TRS12-6-12	12-6-12	2.30
TRS12-8-12	12-8-12	2.30
TRS12-10-12	12-10-12	3.20
TRS15-6-15	15-6-15	3.20
TRS15-8-15	15-8-15	3.20
TRS18-10-18	18-10-18	4.55
TRS18-15-18	18-15-18	4.55



Haakse slangpielaar

NORM	ID. (mm)	€
NOR-WS3	3	0.70
NOR-WS4	4	0.80
NOR-WS5	5	0.85
NOR-WS6	6	0.95
NOR-WS8	8	1.40
NOR-WS10	10	1.80
NOR-WS12	12	2.20
NOR-WS13	13	2.30
NOR-WS14	14	2.60
NOR-WS15	15	3.05
NOR-WS16	16	3.20
NOR-WS19	19	3.90
NOR-WS25	25	4.55



Y-slangpielaar

NORM	ID. (mm)	€
NOR-YS3	3	0.70
NOR-YS4	4	0.70
NOR-YS5	5	0.85
NOR-YS6	6	0.95
NOR-YS8	8	1.50
NOR-YS10	10	1.80
NOR-YS12	12	2.25
NOR-YS13	13	2.45
NOR-YS14	14	2.65
NOR-YS16	16	3.55
NOR-YS19	19	3.85



Y-slangpielaar - verlopemd

NORM	ID. (mm)	€
YRS4-6-4	6-4	0.95
YRS6-8-6	8-6	1.40



Kruis slangpielaar

NORM	ID. (mm)	€
NOR-KS4	4	1.15
NOR-KS5	5	1.40
NOR-KS6	6	1.70
NOR-KS12	12	3.45

KELM™
pneumatiek

Hydrauliek

Snel-
koppelingen

Atsluiters

Roestvast
staal

Fittingen

Lucht-
conditionering

Gereedschap

Pneumatiek

Diversen

Malleabele
fittingen
& staal

Ringleiding-
systemen

Slangen

Compressoren

Slangklemmen



MIKALOR

Milieuvriendelijk: Supra slangklemmen zijn geproduceerd volgens EU richtlijn 2002/95/EC van 1 juli 2006.

Veiligheid: De afgeschuinde hoeken van de slangklemband voorkomen schade aan de slang, en kunnen zo gevaarlijke situaties voorkomen.

Super slangklem

Geel verzinkt en verchromd



Tech Data
1739

Super W1 - zacht staal - stalen schroef

0108		B mm	€
SBC1719	17-19	19,8	0.55
SBC2022	20-22	19,8	0.60
SBC2325	23-25	19,8	0.60
SBC2628	26-28	19,8	0.60
SBC2931	29-31	22	0.75
SBC3235	32-35	22	0.80
SBC3639	36-39	22	0.80
SBC4043	40-43	22	0.90
SBC4447	44-47	24,5	1.30
SBC4851	48-51	24,5	1.30
SBC5255	52-55	24,5	1.35
SBC5659	56-59	24,5	1.40
SBC6063	60-63	24,5	1.45
SBC6467	64-67	24,5	1.45
SBC6873	68-73	26,5	1.90
SBC7479	74-79	26,5	1.95
SBC8085	80-85	26,5	2.05
SBC8691	86-91	26,5	2.05
SBC9297	92-97	26,5	2.20
SBC98103	98-103	26,5	2.20
SBC104112	104-112	26,5	2.30
SBC113121	113-121	26,5	2.45
SBC122130	122-130	26,5	2.85
SBC131139	131-139	29	3.35
SBC140148	140-148	29	3.35
SBC149161	149-161	29	3.95
SBC162174	162-174	29	4.55
SBC175187	175-187	29	4.40
SBC188200	188-200	29	4.70
SBC201213	201-213	29	4.85
SBC214226	214-226	29	5.00
SBC227239	227-239	29	5.05
SBC240252	240-252	29	5.50

Supra slangklem



Tech Data
1740

Supra W2 - RVS AISI-430 - stalen schroef

5555		B mm	€
MS1901	17-19	19,8	1.15
MS1902	19-21	19,8	1.15
MS1903	21-23	19,8	1.15
MS1904	23-25	19,8	1.15
MS1905	25-27	19,8	1.20
MS1906	27-29	19,8	1.20
MS1907	29-31	22	1.45
MS1908	31-34	22	1.50
MS1909	34-37	22	1.75
MS1910	37-40	22	1.75
MS1911	40-43	22	1.75
MS1912	43-47	22	2.20
MS1913	47-51	22	2.30
MS1914	51-55	22	2.30
MS1915	55-59	22	2.40
MS1916	59-63	22	2.40
MS1917	63-68	22	2.45
MS1918	68-73	27,5	3.15
MS1919	73-79	27,5	3.20
MS1920	79-85	27,5	3.30
MS1921	85-91	27,5	3.35
MS1922	91-97	27,5	3.55
MS1923	97-104	27,5	3.55
MS1924	104-112	27,5	3.80
MS1925	112-121	27,5	3.90
MS1926	121-130	27,5	4.00
MS1927	130-140	31	5.60
MS1928	140-150	31	5.75
MS1929	150-162	31	5.40
MS1930	162-174	31	6.05
MS1931	174-187	31	6.20
MS1932	187-200	31	6.35
MS1933	200-213	31	6.45
MS1934	213-226	31	6.70
MS1935	226-239	31	6.85
MS1936	239-252	31	7.05

RVS



Tech Data
1741

Supra W4 - RVS AISI-304 - RVS schroef

0108		B mm	€
SS1301	17-19	19,8	3.10
SS1302	19-21	19,8	3.10
SS1303	21-23	19,8	3.15
SS1304	23-25	19,8	3.20
SS1305	25-27	19,8	3.20
SS1306	27-29	19,8	3.30
SS1307	29-31	22	3.95
SS1308	31-34	22	4.00
SS1309	34-37	22	4.15
SS1310	37-40	22	4.25
SS1311	40-43	22	4.35
SS1312	43-47	22	5.35
SS1313	47-51	22	5.40
SS1314	51-55	22	5.50
SS1315	55-59	22	5.60
SS1316	59-63	22	5.70
SS1317	63-68	22	5.75
SS1318	68-73	27,5	8.10
SS1319	73-79	27,5	8.40
SS1320	79-85	27,5	8.50
SS1321	85-91	27,5	8.75
SS1322	91-97	27,5	8.85
SS1323	97-104	27,5	9.05
SS1324	104-112	27,5	9.30
SS1325	112-121	27,5	9.50
SS1326	121-130	27,5	9.75
SS1327	130-140	31	13.45
SS1328	140-150	31	13.80
SS1329	150-162	31	14.10
SS1330	162-174	31	14.20
SS1331	174-187	31	14.55
SS1332	187-200	31	14.95
SS1333	200-213	31	15.05
SS1334	213-226	31	15.30
SS1335	226-239	31	15.50
SS1336	239-252	31	15.70

Hoofdstuk 13 - Slangen

KELM™
pneumatiek

Hydrauliek

Snel-
koppelingen

Afsluiters

Roestvast
staal

Fittingen

Lucht-
conditionering

Gereedschap

Pneumatiek

Diversen

Malleabele
fittingen
& staal

Ringleiding-
systemen

Slangen

Compressoren

- **tst** (druknop) snelkoppelingen & insteeknippels vanaf pagina 257



tst

Slangklemmen



MIKALOR

Oorklem - enkel



Staal verzinkt

Tech Data
1743

5555



3012080	7-9	0.10
3012072	8-10	0.10
3012013	9-11	0.10
3012021	10-12	0.10
3012030	11-13	0.10
3012048	12-14	0.15
3012056	14-16	0.15
3012064	16-18	0.15

RVS



RVS AISI-304

Tech Data
1744

5555



23012440	7-9	0.25
23012087	8-10	0.30
23012010	9-11	0.30
23012028	10-12	0.30
23012036	11-13	0.35
23012044	12-14	0.35
23012079	13-15	0.35
23012052	14-16	0.35
23012458	15-17	0.40
23012060	16-18	0.40
23012423	17-19	0.45
23012431	18-20	0.45

Oorklem - dubbel



Staal verzinkt

Tech Data
1743

5555



3012101	5-7	0.10
3012110	7-9	0.10
3012128	9-11	0.10
3012099	10-12	0.10
3012136	11-13	0.10
3012144	13-15	0.15
3012152	14-17	0.15
3012160	15-18	0.20
3012179	17-20	0.20
3012187	18-21	0.20
3012195	20-23	0.20
3012208	22-25	0.25
3012216	23-27	0.30
3012224	25-28	0.30
3012232	28-31	0.35
3012240	31-34	0.40
3012259	34-37	0.45
3012267	37-40	0.50
3012275	40-43	0.60
3012283	43-46	0.65

RVS



RVS AISI-304

Tech Data
1744

5555



23012108	5-7	0.20
23012116	7-9	0.30
23012124	9-11	0.30
23012132	11-13	0.30
23012140	13-15	0.35
23012159	14-17	0.40
23012167	15-18	0.40
23012175	17-20	0.45
23012183	18-21	0.50
23012191	20-23	0.50
23012204	22-25	0.65

Oorklem met binnenring - enkel



Staal verzinkt -
binnenring RVS AISI-301

Tech Data
1745

5555



3011009	7,5-8,5	0.20
3011010	8,0-9,5	0.20
3011029	8,5-10,5	0.20
3011037	10-11,5	0.20
3011045	10,5-12,5	0.25
3011053	11,5-13,3	0.25
3011061	13,0-15,3	0.30
3011070	15,0-17,3	0.30

RVS



RVS AISI-304 -
binnenring RVS AISI-301

Tech Data
1745

5555



23012300	7,5-8,5	0.40
23012319	8,2-9,5	0.40
23012327	9,0-10,5	0.40
23012335	10,0-11,5	0.45
23012343	10,5-12,5	0.50
23012351	11,5-13,5	0.55
23012360	12,5-14,5	0.60
23012378	13,0-15,3	0.60
23012386	14,0-16,3	0.60
23012394	15,0-17,3	0.80
23012407	16,0-18,3	0.80
23012415	17,0-19,3	0.80

Hoofdstuk 13 - Slangen

KELM™
pneumatiek

Hydrauliek

Snel-
koppelingen

Atsluiters

Roestvast
staal

Fittingen

Lucht-
conditioning

Gereedschap

Pneumatiek

Diversen

Malleabele
fittingen
& staal

Ringleiding-
systemen

Slangen

Compressoren

JUBILEE® Clipdriver

7mm A/F socket - vaste steel

Tech Data
1940



7mm A/F socket - vaste steel

6666		
2025-3753	95	9.45
2025-3761	160	9.45

JUBILEE® Flexidriver

Voor efficiënte, snelle en eenvoudige aanpassing van Jubilee klemmen. Met flexibele steel, ontworpen voor gebruik op moeilijk bereikbare plekken.

7mm A/F socket

Tech Data
1940



7mm A/F socket

6666	
2025-3779	16.25

JUBILEE® wormschroefklem

No. 1 in the U.K.

Top kwaliteit, Kitemark gekeurd volgens BS 5315:1991 en geproduceerd volgens BS EN ISO 9001:2008. De staal serie is verzinkt ten behoeve van corrosiebestendigheid. De RVS serie is geheel uit RVS-304 (A2) en Lloyd's Register gekeurd.

Tech Data
591



Zacht verzinkt staal - 9mm

6666			
OOO-MS	9	9,5-12	0.65
MOO-MS	9	11-16	0.65
OO-MS	9	13-20	0.75

RVS AISI-304 - 9mm

6666			
OOO-SS	9	9,5-12	2.15
MOO-SS	9	11-16	2.15
OO-SS	9	13-20	2.15

Zacht verzinkt staal - 13mm

6666			
O-MS	13	16-22	0.80
OX-MS	13	18-25	0.80
1A-MS	13	22-30	0.85
1-MS	13	25-35	0.85
1X-MS	13	30-40	1.00
1M-MS	13	32-45	1.00
2A-MS	13	35-50	1.00
2-MS	13	40-55	1.05
2X-MS	13	45-60	1.10
3-MS	13	55-70	1.30
3X-MS	13	60-80	1.40
4-MS	13	70-90	1.40
4X-MS	13	85-100	1.50
5-MS	13	90-120	1.90
6-MS	13	110-140	2.05
6X-MS	13	120-150	2.15
7-MS	13	135-165	2.20
71/2-MS	13	158-190	2.80
81/2-MS	13	184-216	3.05
91/2-MS	13	210-242	3.25
101/2-MS	13	235-267	3.50
111/2-MS	13	260-292	3.75
121/2-MS	13	286-318	4.75

RVS AISI-304 - 13mm

6666			
O-SS	13	16-22	2.60
OX-SS	13	18-25	2.70
1A-SS	13	22-30	2.80
1-SS	13	25-35	3.00
1X-SS	13	30-40	3.05
1M-SS	13	32-45	3.15
2A-SS	13	35-50	3.55
2-SS	13	40-55	3.20
2X-SS	13	45-60	3.70
3-SS	13	55-70	3.95
3X-SS	13	60-80	4.35
4-SS	13	70-90	4.45
4X-SS	13	85-100	4.65
5-SS	13	90-120	5.10
6-SS	13	110-140	5.55
6X-SS	13	120-150	5.75
7-SS	13	135-165	6.00
71/2-SS	13	158-190	6.85
81/2-SS	13	184-216	7.75
91/2-SS	13	210-242	8.75
101/2-SS	13	235-267	9.50
121/2-SS	13	286-318	10.55

Slangklemmen



JUBILEE® Clip dispenser

Ook geschikt voor wandmontage
Eenvoudig aan te vullen
100 klemmen per dispenser

Inhoud:		Type	Aantal
OOO	10	1A	10
MOO	10	1	10
OO	10	1X	10
O	10	1M	10
OX	10	2A	10
		Flexibele schroevendraaier	1



Zacht verzinkt staal

6666

CD-100MS



126.70

JUBILEE® Large clip dispenser

Ook geschikt voor wandmontage
Eenvoudig aan te vullen
140 klemmen per dispenser

Inhoud:		Type	Aantal
OOO	10	OOO	10
MOO	10	MOO	10
OO	10	OO	10
O	10	O	10
OX	10	OX	10
1A	10	1A	10
1	10	1	10
1X	10	1X	10
1M	10	1M	10
2A	10	2A	10
2	10	2	10
2X	10	2X	10
3	10	3	10
3X	10	3X	10
		Flexibele schroevendraaier	3



Zacht verzinkt staal

6666

CD-140MS



255.45



RVS AISI-304

6666

CD-100SS



268.25



RVS AISI-304

6666

CD-140SS



537.15

Hoofdstuk 13 – Slangen

KELM™

pneumatiek

Hydrauliek

Snelkoppelingen

Afsluiters

Roestvast staal

Fittingen

Luchtconditionering

Gereedschap

Pneumatiek

Diversen

Malleabele fittingen & staal

Ringleidingssystemen

Slangen

Compressoren

Slangklemmen



JUBILEE® Workshop assortimentsverpakking

Tech Data
1938



Inhoud:

Type	Aantal
OOO	24
MOO	32
OO	28
O	13
OX	14
1A	12
1	13
1X	7

Een assortiment van 143 wormschroefklemmen in een kunststof box

Zacht verzinkt staal

6666



HCP143

142.95

JUBILEE® Handy Packs

Tech Data
10584



Inhoud:

Type	Aantal
OOO	10
MOO	10
OO	10
O	10
OX	10
1A	10
1	10
1X	10
1M	10
2A	10

Een assortiment van de meest gebruikte maten wormschroefklemmen, individueel verpakt in doosjes van 10 stuks

Zacht verzinkt staal

6666



HP100MS

85.40



RVS AISI-304

6666



HP100SS

244.85

JUBILEE® Junior slangklem (nut en bolt)

Tech Data
10310



Toepassingen:
Olie- en bezineslang,
heaters en slangen
met kleine doorlaat

Zacht verzinkt staal

6666



NB0709	7	9	0.35
NB0810	8	10	0.35
NB0911	9	11	0.35
NB1012	10	12	0.35
NB1113	11	13	0.35
NB1214	12	14	0.35
NB1315	13	15	0.35
NB1416	14	16	0.35
NB1517	15	17	0.35
NB1618	16	18	0.35

JUBILEE® Junior assortimentsverpakking

Tech Data
1938



Inhoud:

Type	Aantal
07-09mm	25
08-10mm	25
09-11mm	25
10-12mm	30
11-13mm	30
12-14mm	30

Een assortiment van 165 slangklemmen (nut & bolt) in een kunststof box (te gebruiken voor met slangen met een kleine doorlaat)

Zacht verzinkt staal

6666



JA165



88.40

JUBILEE® Superclamp éénbouts slangklem

Voor gebruik bij toevoerslang, eenvoudig aan te passen door gebruik van één bout.
Maximaal aanhaalmoment 6 tot 25 Nm (afhankelijk van maatvoering).





Zacht verzinkt staal

6666				€
JSC19	17	19	18	0.95
JSC22	20	22	18	0.95
JSC25	23	25	18	0.95
JSC28	26	28	18	0.95
JSC31	29	31	18	1.00
JSC35	32	35	20	1.35
JSC39	36	39	20	1.35
JSC43	40	43	20	1.40
JSC47	44	47	20	1.45
JSC51	48	51	20	1.50
JSC55	52	55	20	1.50
JSC59	56	59	20	1.65
JSC63	60	63	20	1.65
JSC67	64	67	25	2.70
JSC73	68	73	25	2.75
JSC79	74	79	25	3.05
JSC85	80	85	25	3.10
JSC91	86	91	25	3.20
JSC97	92	97	25	3.25
JSC103	98	103	25	3.35
JSC112	104	112	25	3.35
JSC121	113	121	25	3.45
JSC130	122	130	25	3.75
JSC139	131	139	25	3.85
JSC148	140	148	25	3.90
JSC161	149	161	25	4.05
JSC174	162	174	25	4.35
JSC187	175	187	25	4.45
JSC200	188	200	25	4.55
JSC213	201	213	25	5.00
JSC226	214	226	25	5.45
JSC239	227	239	25	5.95
JSC252	240	255	25	6.50
JSC265	253	265	25	7.05





RVS AISI-304

6666				€
JSC019SS	17	19	18	3.20
JSC022SS	20	22	18	3.35
JSC025SS	23	25	18	3.45
JSC028SS	26	28	18	3.60
JSC031SS	29	31	18	3.65
JSC035SS	32	35	20	3.85
JSC039SS	36	39	20	3.85
JSC043SS	40	43	20	3.85
JSC047SS	44	47	20	3.90
JSC051SS	48	51	20	3.90
JSC055SS	52	55	20	4.00
JSC059SS	56	59	20	4.05
JSC063SS	60	63	20	4.20
JSC067SS	64	67	25	8.10
JSC073SS	68	73	25	8.25
JSC079SS	74	79	25	8.30
JSC085SS	80	85	25	8.40
JSC091SS	86	91	25	8.60
JSC097SS	92	97	25	8.65
JSC103SS	98	103	25	8.80
JSC112SS	104	112	25	8.90
JSC121SS	113	121	25	9.05
JSC130SS	122	130	25	9.35
JSC139SS	131	139	25	9.55
JSC148SS	140	148	25	9.65
JSC161SS	149	161	25	9.85
JSC174SS	162	174	25	10.05
JSC187SS	175	187	25	11.45
JSC200SS	188	200	25	11.85
JSC213SS	201	213	25	12.20
JSC226SS	214	226	25	12.75
JSC239SS	227	239	25	13.30
JSC252SS	240	255	25	13.90
JSC265SS	253	265	25	14.50



RVS AISI-316

6666				€
JSC019SS316	17	19	18	6.35
JSC022SS316	20	22	18	6.50
JSC025SS316	23	25	18	6.85
JSC028SS316	26	28	18	7.05
JSC031SS316	29	31	18	7.30
JSC035SS316	32	35	20	7.60
JSC039SS316	36	39	20	7.05
JSC043SS316	40	43	20	7.70
JSC047SS316	44	47	20	7.70
JSC051SS316	48	51	20	7.85
JSC055SS316	52	55	20	8.00
JSC059SS316	56	59	20	8.10
JSC063SS316	60	63	20	8.25
JSC067SS316	64	67	25	16.00
JSC073SS316	68	73	25	16.25
JSC079SS316	74	79	25	16.45
JSC085SS316	80	85	25	16.50
JSC091SS316	86	91	25	17.00
JSC097SS316	92	97	25	17.10
JSC103SS316	98	103	25	17.35
JSC112SS316	104	112	25	17.60
JSC121SS316	113	121	25	18.00
JSC130SS316	122	130	25	18.40
JSC139SS316	131	139	25	18.80
JSC148SS316	140	148	25	19.05
JSC161SS316	149	161	25	19.45
JSC174SS316	162	174	25	19.90
JSC187SS316	175	187	25	22.65
JSC200SS316	188	200	25	23.30
JSC213SS316	201	213	25	24.05
JSC226SS316	214	226	25	25.10
JSC239SS316	227	239	25	26.25
JSC252SS316	240	252	25	27.45
JSC265SS316	253	265	25	28.55



Slangklemmen



JUBILEE® High Torque wormschroefklem

Aanbevolen aanhaalmoment 11,9 Nm.
Voor toepassingen waar een extra hoog aanhaalmoment nodig is, zoals bij zuigslangen met staaldraad inlage.
8mm A/F socket

Tech Data
1941



RVS

RVS AISI-304 - 16mm

6666		€
JHT35	20-35	5.95
JHT40	25-40	6.00
JHT45	25-45	6.10
JHT50	30-50	6.25
JHT70	40-70	6.50
JHT80	60-80	7.15
JHT95	70-95	7.30
JHT100	80-100	7.25
JHT120	90-120	7.60
JHT140	110-140	8.00
JHT160	130-160	8.55
JHT180	150-180	8.55
JHT200	170-200	9.45
JHT220	190-220	9.90
JHT240	210-240	10.30
JHT260	230-260	10.65
JHT280	250-280	10.60
JHT300	270-300	11.35
JHT320	290-320	11.30
JHT340	310-340	11.60
JHT360	330-360	12.60
JHT380	350-380	12.50
JHT400	370-400	12.95
JHT420	390-420	13.15
JHT440	410-400	14.00
JHT480	450-480	14.95
JHT500	470-500	15.30

JUBILEE® Multiband dispenser

Voor het samenstellen van wormschroefklemmen op gewenste lengte/spanbereik.
RVS AISI-304 wormschroefband met bandbreedte 7mm of 11mm is op aanvraag leverbaar.



Wormschroefband - zacht verzinkt staal - 10 meter

6666		€
2025-3720	11	33.30

Wormschroefband - zacht verzinkt staal - 30 meter

6666		€
2025-3738	11	95.80



Wormschroefhuis en schroef - zacht verzinkt staal - 25 stuks

6666		€
2025-3746	25	30.15

Tech Data 1942

JUBILEE® Multiband Pocket Pack

• inclusief wormschroefhuis en schroef (25 stuks) - zacht verzinkt staal



Wormschroefband - zacht verzinkt staal - 3 meter

6666		€
MB1707	11	27.90

JUBILEE® Multiband Handy Pack

• inclusief wormschroefhuis en schroef (8 stuks) - zacht verzinkt staal



Wormschroefband - zacht verzinkt staal - 10 meter

6666		€
MB1708	11	65.70

- Voor drukknop veiligheidssnelkoppelingen conform ARB0/ISO 4414 zie pagina 257 en 262
- Met Euro, Orion & ISO 6150-C profiel



Slangklemmen



HI-GRIP assortimentsverpakking wormschroefklemmen



Maten van 12mm tot 50mm
135-delige set - zacht verzinkt staal

6695

HGZAB1



143.55

MINI-CLIP assortimentsverpakking wormschroefklemmen



Diameters: 7mm-9mm, 8mm-10mm, 9mm-11mm, 10mm-12mm, 11mm-13mm, 12mm-14mm, 13mm-15mm, 14mm-16mm, 15mm-17mm, 16mm-18mm

157-delige set - zacht verzinkt staal

6695

MCZAB1



133.70



Maten van 12mm tot 50mm
135-delige set - 18/8 marine kwaliteit RVS AISI-304

6695

HGSAB1

RVS



417.80

Hoofdstuk 13 – Slangen

KELM™
pneumatiek

Hydrauliek

Snel-
koppelingen

Atsluiters

Roestvast
staal

Fittingen

Lucht-
conditionering

Gereedschap

Pneumatiek

Diversen

Malleabele
fittingen
& staal

Ringleiding-
systemen

Slangen

Compressoren

Slangklemmen



HI-TORQUE wormschroefklem - heavy duty

Materiaal:
RVS BS304
(schroef RVS
BS410)



RVS BS304 - RVS BS410 schroef -
16mm

6695	B mm	min mm	max mm	€
HT27	16	20	27	6.70
HT30	16	20	30	6.70
HT35	16	20	35	6.70
HT40	16	25	40	6.70
HT45	16	25	45	6.80
HT50	16	30	50	6.90
HT60	16	40	60	7.10
HT65	16	45	65	7.35
HT70	16	50	70	7.35
HT80	16	60	80	7.55
HT90	16	70	90	7.70
HT95	16	75	95	7.85
HT100	16	80	100	8.05
HT120	16	90	120	8.35
HT140	16	110	140	8.70
HT160	16	130	160	9.15
HT180	16	150	180	9.50
HT200	16	170	200	10.00
HT220	16	190	220	10.50
HT240	16	210	240	10.80
HT260	16	230	260	11.25
HT280	16	250	280	11.65
HT320	16	290	320	12.55
HT340	16	310	340	12.90
HT360	16	330	360	13.30
HT380	16	350	380	13.70
HT400	16	370	400	14.10
HT420	16	390	420	14.40
HT440	16	410	440	14.95
HT460	16	430	460	13.30
HT480	16	450	480	15.75
HT500	16	470	500	16.10

HI-GRIP wormschroefklem - vleugelschroef

Materiaal: Zacht
verzinkt staal



Zacht verzinkt staal - 9mm

6695	B mm	min mm	max mm	€
510-12	9	9.5	12	1.10
510-16	9	11	16	1.20
510-20	9	13	20	1.20

Zacht verzinkt staal - 13mm

6695	B mm	min mm	max mm	€
510-22	13	14	22	1.20
510-25	13	17	25	1.35
510-30	13	22	30	1.35
510-35	13	25	35	1.40
510-40	13	30	40	1.40
510-45	13	35	45	1.40
510-50	13	35	50	1.70
510-55	13	40	55	1.50
510-60	13	45	60	1.70

HI-GRIP wormschroefklem



Zacht verzinkt staal - 9mm

6695	B mm	min mm	max mm	€
WDHC000	9	9.5	12	0.65
WDHCM00	9	11	16	0.65
WDHCOO	9	13	20	0.65

Zacht verzinkt staal - 13mm

6695	B mm	min mm	max mm	€
WDHCO	13	14	22	0.70
WDHCOX	13	17	25	0.75
WDHC1A	13	22	30	0.75
WDHC1	13	25	35	0.80
WDHC1X	13	30	40	0.80
WDHC2A	13	35	50	0.90
WDHC2	13	40	55	0.90
WDHC2X	13	45	60	0.95
WDHC3	13	50	70	1.10
WDHC3X	13	60	80	1.20
WDHC4	13	70	90	1.40
WDHC4X	13	80	100	1.50
WDHC5	13	90	120	1.90

RVS BS304 - 9mm

6695	B mm	min mm	max mm	€
WDHC000-SS	9	9.5	12	2.40
WDHCM00-SS	9	11	16	2.40
WDHCOO-SS	9	13	20	2.40

RVS BS304 - 13mm

6695	B mm	min mm	max mm	€
WDHCO-SS	13	14	22	2.85
WDHCOX-SS	13	17	25	2.85
WDHC1A-SS	13	22	30	2.90
WDHC1-SS	13	25	35	3.00
WDHC1X-SS	13	30	40	3.15
WDHC2A-SS	13	35	50	3.45
WDHC2-SS	13	40	55	3.65
WDHC2X-SS	13	45	60	3.80
WDHC3-SS	13	50	70	4.15
WDHC3X-SS	13	60	80	4.40
WDHC4-SS	13	70	90	4.80
WDHC4X-SS	13	80	100	5.00
WDHC5-SS	13	90	120	5.60
WDHC6-SS	13	110	140	6.10
WDHC7-SS	13	130	160	6.70

HI-GRIP dispenser

100 stuks staal verzinkt wormschroefklemmen - maten van 12mm tot 50mm
(10 stuks per maat) 1 flexibele schroevendraaier



Zacht verzinkt staal - 100 wormschroefklemmen

6695



DISPKZ1

176.80

160 stuks staal verzinkte wormschroefklemmen - maten van 12mm tot 100mm
(10 stuks per maat) 1 flexibele schroevendraaier



Zacht verzinkt staal - 160 wormschroefklemmen

6695



DISPKZ2

266.40

100 stuks RVS BS304 wormschroefklemmen - maten van 12mm tot 50mm
(10 stuks per maat) 1 flexibele schroevendraaier



RVS BS304 - 100 wormschroefklemmen

6695



DISPKS1

406.70

160 stuks RVS BS304 wormschroefklemmen - maten van 12mm tot 100mm
(10 stuks per maat) 1 flexibele schroevendraaier



RVS BS304 - 160 wormschroefklemmen

6695



DISPKS2

683.60

Slangklemmen



Hoofdstuk 13 – Slangen

NOVA wormschroefklem



Band: 8-12 tot 40mm: Galfan
32-44 tot 85mm: Aluzink
Wormhuis: Blauw gelakt
Schroef: Verzinkt staal



Aluzink - verzinkt stalen schroef - S20/9mm

ABA		B mm	€
ABA3240015	8-14	9	0.80
ABA3240017	11-17	9	0.80
ABA3240022	13-20	9	0.80
ABA3240025	15-24	9	0.90
ABA3240028	19-28	9	1.00
ABA3240032	22-32	9	1.00
ABA3240040	26-38	9	1.00
ABA3240045	32-44	9	1.10
ABA3240051	38-50	9	1.15
ABA3240056	44-56	9	1.20
ABA3240065	50-65	9	1.35
ABA3240075	58-75	9	1.50
ABA3240085	68-85	9	1.65

ORIGINAL wormschroefklem



Band: 8-12 tot 40mm: Galfan
32-44 tot 95mm: Aluzink
Wormhuis: Blauw gelakt
Schroef: Verzinkt staal



Aluzink - verzinkt stalen schroef - S20/12mm

ABA		B mm	€
ABA3110024	15-24	12	1.00
ABA3110028	19-28	12	1.05
ABA3110032	22-32	12	1.10
ABA3110038	26-38	12	1.10
ABA3110044	32-44	12	1.20
ABA3110050	38-50	12	1.20
ABA3110056	44-56	12	1.35
ABA3110065	50-65	12	1.65
ABA3110075	58-75	12	1.85
ABA3110085	68-85	12	1.85
ABA3110095	77-95	12	2.00



Geheel RVS 304

RVS



W4 geheel RVS 2333/AISI-304 - S40/9mm

ABA		B mm	€
ABA3440015	8-14	9	3.55
ABA3440017	11-17	9	3.25
ABA3440022	13-20	9	3.25
ABA3440025	15-24	9	3.30
ABA3440028	19-28	9	3.30
ABA3440032	22-32	9	3.30
ABA3440040	26-38	9	3.30



Geheel RVS 304

RVS



W4 geheel RVS 2333/AISI-304 - S40/12mm

ABA		B mm	€
ABA3411024	15-24	12	3.60
ABA3411028	19-28	12	3.65
ABA3411032	22-32	12	3.70
ABA3411038	26-38	12	3.75
ABA3411044	32-44	12	4.00
ABA3411050	38-50	12	4.15
ABA3411056	44-56	12	4.65
ABA3411065	50-65	12	5.00
ABA3411075	58-75	12	5.10
ABA3411085	68-85	12	5.40
ABA3411095	77-95	12	5.80

Slangklemmen



Toepassing: Veelvuldig toegepast in industrie, landbouw en automotive.

Materiaal codes

W1: alle delen van verzinkt staal.

W2: wormschroef van verzinkt staal, band & huis van RVS-AISI-430

W4: alle delen van RVS-AISI-304

W2 wormschroefklem

Tech Data
20401



RVS - verzinkt stalen schroef - 9mm

WORM		B mm	€
40480812	8-12	9	0.60
40481016	10-16	9	0.70
40481220	12-20	9	0.70
40481625	16-25	9	0.70
40582032	20-32	9	0.80
40482540	25-40	9	0.80
40483250	32-50	9	0.90
40483545	35-45	9	0.90
40484060	40-60	9	1.00
40481012	100-120	9	1.50
40481214	120-140	9	1.75

RVS - verzinkt stalen schroef - 12mm

WORM		B mm	€
40583250	32-50	12	1.25
40585070	50-70	12	1.50
40586080	60-80	12	1.70
40587090	70-90	12	1.80
40488010	80-100	12	1.85
40589010	90-110	12	2.20
40581012	100-120	12	2.30
40581113	110-130	12	2.45
40581214	120-140	12	2.50
40581315	130-150	12	2.80
40581416	140-160	12	2.80

Hi-grip mini wormschroefklem

Tech Data
20459

Zacht verzinkt staal

WORM		B mm	€
505-9	7-9	9	0.45
505-10	8-10	9	0.45
505-11	9-11	9	0.45
505-12	10-12	9	0.45
505-13	11-13	9	0.45
505-14	12-14	9	0.45
505-15	13-15	9	0.45
505-16	14-16	9	0.45
505-17	15-17	9	0.45
505-18	16-18	9	0.45

W4 wormschroefklem

Tech Sheet
20402



Geheel RVS - 9mm

WORM		B mm	€
60480812	8-12	9	1.25
60481016	10-16	9	1.25
60481625	16-25	9	1.35
60481220	12-20	9	1.70
60482032	20-32	9	1.80
60482540	25-40	9	1.80
60483250	32-50	9	1.80
60484060	40-60	9	1.90
60485070	50-70	9	2.00

Geheel RVS - 12mm

WORM		B mm	€
60582032	20-32	12	1.80
60585070	50-70	12	2.10
60587090	70-90	12	2.95
60589011	90-110	12	3.20
60581113	110-130	12	3.75
60581315	130-150	12	4.10
60581416	140-160	12	4.40



RVS

WORM		B mm	€
505-9SS	7-9	9	1.10
505-10SS	8-10	9	1.15
505-11SS	9-11	9	1.15
505-12SS	10-12	9	1.15
505-13SS	11-13	9	1.15
505-14SS	12-14	9	1.15
505-15SS	13-15	9	1.15
505-16SS	14-16	9	1.15
505-17SS	15-17	9	1.25
505-18SS	16-18	9	1.25



Hoofdstuk 13 - Slangen

KELM™
pneumatiek

Hydrauliek

Snel-
koppelingen

Atsluiters

Roestvast
staal

Fittingen

Lucht-
conditioning

Gereedschap

Pneumatiek

Diversen

Malleabele
fittingen
& staal

Ringleiding-
systemen

Slangen

Compressoren

Slangklemmen



Snelsluitslangklem

Tech Data
20460



RVS

WORM	SPAN REPER	B mm	€
G76028	25-57		3.50
G76036	25-70		3.75
G76048	38-89		4.60
G76056	25-101		4.80
G76072	51-127		5.25
G76088	52-152		5.75
G76104	45-177		6.50
G76128	45-217		6.75
G76152	50-254		7.15
G76188	52-312		8.15
G76216	258-355		8.90
G76248	45-406		9.55
G76280	361-457		10.70
G76312	355-508		11.05
G76344	45-559		12.25

Oorklem

Tech Data
588



Dubbel - zacht staal

OORK	SPAN REPER	B mm	€
40350305	3-5	5	0.35
40350507	5-7	6	0.20
40350709	7-9	6	0.20
40350911	9-11	6.5	0.20
40351113	11-13	6.5	0.30
40351315	13-15	7	0.30
40351518	15-18	7.5	0.40
40351720	17-20	7.5	0.40
40352023	20-23	8	0.55
40352225	22-25	8.5	0.60
40352327	23-27	8.5	0.65
40352528	25-28	9	0.70
40352731	27-31	9	0.75
40353134	31-34	9.5	0.95
40353437	34-37	9.5	1.15
40353740	37-40	10	1.50
40354043	40-43	10	0.95

Easygrip wormschroefklem - vleugelschroef

Tech Data
20410



Staal

WORM	SPAN REPER	B mm	€
EGHC8-12	8-12	9	0.60
EGHC10-16	10-16	9	0.60
EGHC12-20	12-20	9	0.60
EGHC16-25	16-25	9	0.60
EGHC20-32	20-32	9	0.60
EGHC25-40	25-40	9	0.65
EGHC32-50	32-50	9	0.65
EGHC35-45	35-45	9	0.65
EGHC40-60	40-60	9	0.70
EGHC50-70	50-70	9	0.75
EGHC60-80	60-80	9	0.85
EGHC70-90	70-90	9	0.95
EGHC80-100	80-100	9	1.00



Tech Data
20411
20412

Enkel - RVS

OORK	SPAN REPER	B mm	€
SEHC6.5	5-6.5	5	0.40
SEHC7	5.8-7	5	0.40
SEHC8	6.8-8	5	0.40
SEHC8.7	7-8.7	5	0.40
SEHC9.5	7.8-9.5	5	0.40
SEHC10.5	8.8-10.5	5	0.40
SEHC11.3	9.6-11.3	7	0.40
SEHC11.9	10.2-11.9	7	0.55
SEHC12.3	10.6-12.3	7	0.55
SEHC13.3	10.8-13.3	7	0.55
SEHC14	11.5-14	7	0.55
SEHC14.5	12-14.5	7	0.55
SEHC15.3	12.8-15.3	7	0.55
SEHC16.2	13.7-16.2	7	0.60
SEHC17.5	15-17.5	7	0.60
SEHC18.5	15.3-18.5	7	0.60
SEHC19.2	16-19.2	7	0.60
SEHC22.6	19.4-22.6	7	0.65
SEHC23.5	20.4-23.6	7	0.65
SEHC24.1	20.9-24.1	7	0.65
SEHC27.1	23.9-27.1	7	0.70
SEHC32.1	28.9-32.1	7	0.85
SEHC34.6	31.4-34.6	7	0.85
SEHC41	37.8-41	7	0.95
SEHC42.5	39.3-42.5	7	1.00
SEHC44	40.8-44	7	1.00
SEHC51.5	48.3-51.5	7	1.00
SEHC63.5	60.3-63.5	7	1.30

Slangklemmen



Tech Data **20468**

Assortimentsverpakking

Inhoud:

8-12mm 14x
10-16mm 10x
12-22mm 10x
16-27mm 8x
20-32mm 7x
25-40mm 6x



Wormschroefklemmen



HC-KIT-MS	Zacht staal	52.65
HC-KIT-SS	RVS	129.05

Inhoud:

7-9mm 21x
8-10mm 20x
9-11mm 15x
10-12mm 15x
11-13mm 14x
12-14mm 8x
13-15mm 10x
15-17mm 7x
16-18mm 6x

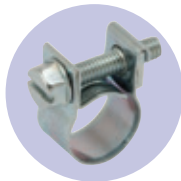

Hi-grip mini wormschroefklemmen



HCMINI-KIT-MS	Zacht staal	64.45
HCMINI-KIT-SS	RVS	162.95

Inhoud:

9-11mm 34x
11-13mm 26x
13-15mm 18x
14-17mm 14x
15-18mm 24x
17-20mm 20x
18-21mm 20x
22-25mm 12x
Knijptang 1x

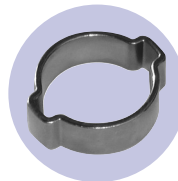

Oorklemmen



OC-KIT-MS	Zacht staal	118.05
------------------	-------------	---------------

Hoofdstuk 13 – Slangen

KELM™

pneumatiek

Hydrauliek

Snelkoppelingen

Atsluiters

Roestvast staal

Fittingen

Luchtconditionering

Gereedschap

Pneumatiek

Diversen

Malleabele fittingen & staal

Ringleidingssystemen

Slangen

Compressoren

Slangklemmen



Hoofdstuk 13 – Slangen

Wormschroefklemmen display



INHOUD:

1x	Flexibele schroevendraaier	12x	25-40mm
1x	Wandrek	12x	32-50mm
12x	8-12mm	12x	35-45mm
12x	10-16mm	12x	40-60mm
12x	12-20mm	12x	50-70mm
12x	16-25mm	9x	60-80mm
12x	20-32mm	9x	70-90mm

RVS - verzinkt stalen schroef - voor wandmontage



HC-DS

90.45

Knijptang



Voor oorklemmen



OP1

8.70

Flexibele schroevendraaier



Voor wormschroefklemmen



40580008

SK-flex

7.45

Snap clip



Acetaal - herbruikbaar



PC8-10	8	10	0.60
PC11-13	11	13	0.60
PC14-16	14	16	0.80
PC15-17	15	17	0.70
PC16-18	16	18	0.80
PC17-19	17	19	0.70
PC23-25	23	25	0.70
PC26-28	26	28	1.00
PC30-32	30	32	1.35
PC44-46	44	46	1.35
PC10-12	11	13	0.70
PC13-15	10	12	0.80
PC18-20	18	20	0.70
PC21-23	21	23	0.80

• **tst** (drukknop) snelkoppelingen & insteeknippels vanaf pagina 257

tst



Slangklemmen



Eenbouts heavy duty slangklem

Tech Data
20405

W4 - RVS AISI-304



WORM			€
SHC-1719	17-19		3.90
SHC-2022	20-22		4.10
SHC-2325	23-25		4.00
SHC-2628	26-28		4.00
SHC-2931	29-31		4.80
SHC-3235	32-35		5.10
SHC-3639	36-39		5.00
SHC-4043	40-43		5.00
SHC-4447	44-47		7.70
SHC-4851	48-51		8.20
SHC-5255	52-55		8.85
SHC-5659	56-59		8.85
SHC-6063	60-63		8.80
SHC-6467	64-67		8.80
SHC-6873	68-73		10.05
SHC-7479	74-79		10.05
SHC-8085	80-85		10.45
SHC-8691	86-91		10.45
SHC-9297	92-97		10.55
SHC-98103	98-103		11.25
SHC-104112	104-112		10.85
SHC-113121	113-121		11.60
SHC-122130	122-130		11.70
SHC-131139	131-139		14.35
SHC-140148	140-148		15.30
SHC-149161	149-161		16.70
SHC-162174	162-174		16.70
SHC-175187	175-187		16.70
SHC-188200	188-200		16.80
SHC-201213	201-213		16.15
SHC-214226	214-226		16.95
SHC-227239	227-239		19.45
SHC-240252	240-252		16.95

Tech Data
20403

W1 - staal



WORM			€
HDSHS-1719	17-19		1.85
HDSHS-2022	20-22		1.85
HDSHS-2325	23-25		1.90
HDSHS-2628	26-28		1.90
HDSHS-2931	29-31		2.25
HDSHS-3235	32-35		2.25
HDSHS-3639	36-39		2.25
HDSHS-4043	40-43		2.35
HDSHS-4447	44-47		3.10
HDSHS-4851	48-51		3.40
HDSHS-5255	52-55		3.40
HDSHS-5659	56-59		3.40
HDSHS-6063	60-63		3.40
HDSHS-6467	64-67		3.40
HDSHS-6873	68-73		4.40
HDSHS-7479	74-79		4.40
HDSHS-8085	80-85		4.30
HDSHS-8691	86-91		4.80
HDSHS-9297	92-97		4.30
HDSHS-98103	98-103		5.00
HDSHS-104112	104-112		5.05
HDSHS-113121	113-121		4.80
HDSHS-122130	122-130		5.35
HDSHS-131139	131-139		5.35
HDSHS-140148	140-148		5.35
HDSHS-149161	149-161		6.45
HDSHS-162174	162-174		5.90
HDSHS-175187	175-187		5.80
HDSHS-188200	188-200		6.45
HDSHS-201213	201-213		7.10
HDSHS-214226	214-226		6.60
HDSHS-227239	227-239		6.50
HDSHS-240252	240-252		6.45

Tweebouts heavy duty slangklem

Tech Data
20404

Gegalvaniseerd



WORM			€
MIPC-1722	MAL-STEEL W1-2B	17-22	2.25
MIPC-2229	MAL-STEEL W1-2B	22-29	2.45
MIPC-2934	MAL-STEEL W1-2B	29-34	2.60
MIPC-3440	MAL-STEEL W1-2B	34-40	3.25
MIPC-3949	MAL-STEEL W1-2B	39-49	4.80
MIPC-4860	MAL-STEEL W1-2B	48-60	5.35
MIPC-6076	MAL-STEEL W1-2B	60-76	5.90
MIPC-7794	MAL-STEEL W1-2B	77-94	9.85
MIPC-94115	MAL-STEEL W1-2B	94-115	10.85
MIPC-400	MAL-STEEL W1-2B	88-96	12.45
MIPC-463	MAL-STEEL W1-2B	102-108	13.15
MIPC-525	MAL-STEEL W1-2B	108-125	15.30
MIPC-550	MAL-STEEL W1-2B	114-128	15.95
MIPC-600	MAL-STEEL W1-2B	130-144	19.10
MIPC-675	MAL-STEEL W1-2B	151-165	19.75
MIPC-769	MAL-STEEL W1-2B	165-192	24.40
MIPC-875	MAL-STEEL W1-2B	210-225	34.95
MIPC-988	MAL-STEEL W1-2B	227-239	42.00
MIPC-1125	MAL-STEEL W1-2B	252-289	68.25
MIPC-1450	MAL-STEEL W1-2B	335-381	148.85

Tweebouts slangklem

Verzinkt/geel gepasseerd



WORM	min mm	max mm	€
HD.000	17	22	2.55
HD.001	20	29	3.70
HD.002	28	35	3.70
HD.003	32	40	5.25
HD.004	39	49	6.80
HD.005	48	60	7.95
HD.006	60	76	10.10
HD.007	77	94	15.70
HD.1	89	101	15.70
HD.2	101	113	24.20
HD.3	113	127	28.35
HD.5	140	154	33.90
HD.6	154	175	39.40
HD.7	175	194	40.00
HD.9	210	225	53.25

KELM™
pneumatiek

Hydrauliek

Snel-
koppelingen

Atsluiters

Roestvast
staal

Fittingen

Lucht-
conditionering

Gereedschap

Pneumatiek

Diversen

Malleabele
fittingen
& staal

Ringleiding-
systemen

Slangen

Compressoren

Slangklemmen

COBRA schroefloze spanklem



RVS

W4 - RVS AISI-304

NORM	B mm	OD mm	€
COBRA75	7	7,5	0.80
COBRA8	7	8	0.80
COBRA85	7	8,5	0.80
COBRA9	7	9	0.80
COBRA95	7	9,5	0.80
COBRA10	7	10	0.80
COBRA105	7	10,5	0.80
COBRA11	7	11	0.80
COBRA115	7	11,5	0.80
COBRA12	8	12	0.85
COBRA13	8	13	0.85
COBRA14	8	14	0.85
COBRA15	8	15	0.85
COBRA16	8	16	0.85
COBRA17	8	17	0.85
COBRA18	8	18	0.85
COBRA19	8	19	0.85
COBRA20	8	20	0.85
COBRA21	8	21	0.90
COBRA22	8	22	0.90
COBRA23	8	23	0.90
COBRA24	8	24	0.90
COBRA25	8	25	0.90
COBRA26	8	26	0.90
COBRA27	8	27	0.90
COBRA28	8	28	0.95
COBRA29	8	29	0.95
COBRA30	8	30	0.95



Montagegereedschap voor Cobra spanklem

NORM	€
COB-TOOL Cobra montagegereedschap	124.75

TORRO wormschroefklem



W1 DIN 3017 - verzinkt staal

NORM	B mm	€	
NOR-000	8-12	9	0.65
NOR-MOO	10-16	9	0.65
NOR-00	12-22	9	0.65
NOR-O	16-27	12	0.80
NOR-1A	20-32	12	0.80
NOR-1	25-40	12	0.85
NOR-2A	35-50	12	0.95
NOR-2	40-60	12	1.15
NOR-3	50-70	12	1.25
NOR-3X	60-80	12	1.50
NOR-4	70-90	12	1.70
NOR-4X	80-100	12	1.70
NOR-5	90-110	12	2.00

Voor

NORMA

bevestigings-
materiaal



...zie hoofdstuk 12

TORRO RVS wormschroefklem



RVS

W4 DIN 3017 - RVS AISI-304

NORM	B mm	€	
SS-75-12	8-12	7,5	1.50
SS-75-16	10-16	7,5	1.70
SS-75-18	12-18	7,5	1.70
SS-000	8-16	9	2.25
SS-00	12-22	9	2.50
SS-O	16-27	12	2.90
SS-1A	20-32	12	2.90
SS-1	25-40	12	3.10
SS-2A	32-50	12	3.25
SS-2	40-60	12	3.45
SS-3	50-70	12	3.65
SS-3X	60-80	12	4.00
SS-4	70-90	12	4.65
SS-4X	80-100	12	4.90
SS-5	90-110	12	5.10



Heavy duty W4 DIN 3017-RVS AISI-304

RVS

NORM	B mm	€	
HD45	25-45	16	12.25
HD54	32-54	16	12.65
HD67	45-67	16	12.65
HD79	57-79	16	13.10
HD92	70-92	16	13.60
HD105	83-105	16	14.15
HD118	95-118	16	14.65
HD130	108-130	16	15.20
HD143	121-143	16	15.30
HD156	133-156	16	15.70
HD168	146-168	16	15.90
HD181	159-181	16	16.30
HD194	172-194	16	17.30
HD206	184-206	16	17.95
HD219	197-219	16	18.45
HD232	210-232	16	18.75

GBS heavy duty wormschoefklem



W1 DIN 3017 - verzinkt staal

NORM	Ø (mm)	B (mm)	€
GBSW1-17-19	17-19	18	2.65
GBSW1-19-21	19-21	18	2.65
GBSW1-21-23	21-23	18	2.65
GBSW1-23-25	23-25	18	2.65
GBSW1-25-27	25-27	18	2.70
GBSW1-27-29	27-29	18	2.70
GBSW1-29-31	29-31	18	2.90
GBSW1-31-34	31-34	18	2.90
GBSW1-34-37	34-37	18	2.90
GBSW1-37-40	37-40	18	2.90
GBSW1-40-43	40-43	18	2.90
GBSW1-43-47	43-47	20	3.05
GBSW1-47-51	47-51	20	3.05
GBSW1-51-55	51-55	20	3.05
GBSW1-55-59	55-59	20	3.05
GBSW1-59-63	59-63	20	3.10
GBSW1-63-68	63-68	20	3.10
GBSW1-68-73	68-73	25	3.65
GBSW1-73-79	73-79	25	3.65
GBSW1-79-85	79-85	25	3.80
GBSW1-85-91	85-91	25	3.80
GBSW1-91-97	91-97	25	4.00
GBSW1-97-104	97-104	25	4.10
GBSW1-104-114	104-114	25	4.10
GBSW1-114-121	114-121	25	4.25
GBSW1-121-130	121-130	25	4.65
GBSW1-130-140	130-140	30	5.85
GBSW1-140-150	140-150	30	6.10
GBSW1-150-162	150-162	30	7.60
GBSW1-162-174	162-174	30	7.35
GBSW1-174-187	174-187	30	8.25
GBSW1-187-200	187-200	30	8.50
GBSW1-200-213	200-213	30	9.10
GBSW1-213-226	213-226	30	9.30
GBSW1-226-239	226-239	30	9.55
GBSW1-239-252	239-252	30	9.75

GBS heavy duty RVS wormschoefklem



W4 DIN 3017 - RVS AISI-304

NORM	Ø (mm)	B (mm)	€
GBSW4-17-19	17-19	18	7.35
GBSW4-19-21	19-21	18	7.35
GBSW4-21-23	21-23	18	7.45
GBSW4-23-25	23-25	18	7.45
GBSW4-25-27	25-27	18	7.45
GBSW4-27-29	27-29	18	7.55
GBSW4-29-31	29-31	18	7.55
GBSW4-31-34	31-34	18	7.60
GBSW4-34-37	34-37	18	7.70
GBSW4-37-40	37-40	18	7.80
GBSW4-40-43	40-43	18	8.00
GBSW4-43-47	43-47	20	10.55
GBSW4-47-51	47-51	20	10.60
GBSW4-51-55	51-55	20	10.65
GBSW4-55-59	55-59	20	10.75
GBSW4-59-63	59-63	20	10.85
GBSW4-63-68	63-68	20	10.95
GBSW4-68-73	68-73	25	16.75
GBSW4-73-79	73-79	25	16.95
GBSW4-79-85	79-85	25	17.15
GBSW4-85-91	85-91	25	17.30
GBSW4-91-97	91-97	25	17.45
GBSW4-97-104	97-104	25	17.95
GBSW4-104-114	104-114	25	18.25
GBSW4-114-121	114-121	25	18.55
GBSW4-121-130	121-130	25	18.95
GBSW4-130-140	130-140	30	28.90
GBSW4-140-150	140-150	30	29.20
GBSW4-150-162	150-162	30	29.40
GBSW4-162-174	162-174	30	30.35
GBSW4-174-187	174-187	30	30.90
GBSW4-187-200	187-200	30	31.25
GBSW4-200-213	200-213	30	31.90
GBSW4-213-226	213-226	30	32.50
GBSW4-226-239	226-239	30	33.05
GBSW4-239-252	239-252	30	33.85

Wormschoefband

Voor het op maat maken van wormschoefklemmen.



Wormschoefband W1 - verzinkt staal - 30 meter lengte

NORM	B (mm)	L (m)	€
BAND-W1	12	30	105.00



Wormschoefhuis W1 - verzinkt staal - 50 stuks

NORM	B (mm)	L (m)	€
NBG-12W1	12	50	56.55

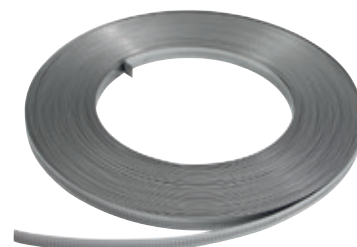

Wormschoefband W3 - verchromd staal - 30 meter lengte

NORM	B (mm)	L (m)	€
BAND-W3	12	30	139.20



Wormschoefhuis W3 - verchromd staal - 50 stuks

NORM	B (mm)	L (m)	€
NBG-12W3	12	50	95.60

- KELM™ pneumatiek
- Hydrauliek
- Snelkoppelingen
- Atsluiters
- Roestvast staal
- Fittingen
- Luchtconditionering
- Gereedschap
- Pneumatiek
- Diversen
- Malleabele fittingen & staal
- Ringleidingssystemen
- Slangen
- Compressoren

Buiskoppelingen

Het CONNECT-assortiment maakt lasvrije verbindingen mogelijk van buizen met gladde einden in o.a. de leidingbouw, scheepsbouw, offshore, machinebouw, chemische installaties, petrochemische industrie, irrigatie- en afvalwaterinstallaties.



Kenmerken:

- Eenvoudig te monteren en te demonteren
- Axiale treksterkte (type GRIP)
- Alleen afdichting (type FLEX)
- Herbruikbaar
- Gepatenteerde dubbele lipafdichting
- Standaard staalbandinlage
- Geschikt voor vacuüm- en druktoepassingen
- Tot 16 bar (nominale) druk

NORMACONNECT® REP E

Geschikt voor buisreparatie van metalen en kunststof buizen.

Tech Data
60060



RVS

W5 - NBR

	7788			€
Hydrauliek	NOR-FGRR355	34.5	35.5	146.05
	NOR-FGRR429	39	42.9	147.85
Snelkoppelingen	NOR-FGRR45	43	45	147.85
	NOR-FGRR488	45.5	48.8	148.80
Afsluiters	NOR-FGRR549	53.6	54.9	148.80
	NOR-FGRR576	55	57.6	148.80
Roestvast staal	NOR-FGRR609	57.7	60.9	151.85
	NOR-FGRR74	72.6	74	185.25
Fittingen	NOR-FGRR769	74	76.9	185.25
	NOR-FGRR85	83	85	185.25
Luchtconditionering	NOR-FGRR896	85.1	89.8	188.70
	NOR-FGRR1029	101	102.9	195.85
Gereedschap	NOR-FGRR106	103	106	195.90
	NOR-FGRR111	109	111	195.90
Pneumatiek	NOR-FGRR1154	112	115.4	201.70
	NOR-FGRR156	153	156	271.05
Diversen	NOR-FGRR170	166	170	277.50

NORMACONNECT® GRIP

Voor het verbinden van niet-ingelemde metalen buizen.

Tech Data
60061



W2 - NBR

	7788			€
Hydrauliek	NOR-05788400026	26.4	27.5	80.35
	NOR-05788400033	33	34.3	85.30
Snelkoppelingen	NOR-05788400042	41.7	43	87.00
	NOR-05788400048	47.6	50.5	87.00
Afsluiters	NOR-05788400060	59.5	61	93.85
	NOR-05788400076	75.2	77	116.00
Roestvast staal	NOR-05788400088	87	89.9	122.75
	NOR-05788400114	113	115	141.25
Fittingen	NOR-05788400139	138.1	141.6	187.40
	NOR-05788400168	166.5	170.1	215.25
Luchtconditionering	NOR-05778400219	216	221	482.55

NORMACONNECT® FLEX

Voor het verbinden van ingeleemde metalen en kunststof buizen.

Tech Data
60062



W2 - NBR

	7788			€
Hydrauliek	NOR-05738400026	26.5	27.4	71.25
	NOR-05738400033	33	34.3	75.55
Snelkoppelingen	NOR-05738400042	41.7	43	87.90
	NOR-05738400048	47.6	50.5	85.30
Afsluiters	NOR-05738400060	59.5	61	89.55
	NOR-05738400076	75.2	77	110.95
Roestvast staal	NOR-05738400088	87	89.9	113.40
	NOR-05738400114	113	115.5	115.90
Fittingen	NOR-05738400139	138.1	141.6	157.35
	NOR-05738400168	166.5	170.1	170.60
Luchtconditionering	NOR-05738400180	178	182	270.95
	NOR-05738400193	192	196	270.95
Gereedschap	NOR-05738400206	202	208	332.70
	NOR-05738400219	216	221	313.60
Pneumatiek	NOR-05738400267	264	269	322.60
	NOR-05738400355	352	359	387.50
Diversen	NOR-05738400406	402	410	455.40
	NOR-05738400508	505	510	449.20
Malleabele fittingen & staal	NOR-05738400609	606	613	482.65

KELM™
pneumatiek

Hydrauliek

Snelkoppelingen

Afsluiters

Roestvast staal

Fittingen

Luchtconditionering

Gereedschap

Pneumatiek

Diversen

Malleabele fittingen & staal

Ringleidingssystemen

Slangen

Compressoren

CONAH

Waarom de keuze voor CONAH slanghaspels?

- Scherp geprijsde slanghaspels
- Op aanvraag volledig samengesteld volgens uw specificaties
- Een volledige range slanghaspels in kunststof en metaal
- Uitvoeringen voor lage-, medium- en hogedruk toepassingen van 12 bar tot 270 bar
- Alle hogedruk slanghaspels worden geassembleerd door BFPA opgeleide technici
- Vloer-, wand- of plafondmontage opties



Kenmerken:

- Minder slijtage en beschadiging
- Verhoogde efficiëntie
- Eenvoudig in gebruik en opslag
- Veiligheid vooropgesteld – voorkom schade en letsel op de werkvloer
- Compacte uitvoeringen voor toepassing in beperkte ruimte



Gesloten kunststof veerslanghaspels - perslucht

- Gewapende PU slang.
- Sterke slagvaste polypropyleen constructie
- 180° swivel.
- Automatisch oprolmechanisme.
- Mechanisme voor automatische vergrendeling van de slang op elke gewenste lengte.
- Lichtgewicht.

Maximale werkdruk: 12 bar

Tech Data 10179

Perslucht - 9 meter PU slang ID 8mm

0800	L mtrs	-ID-	Inlet	Outlet	€
ZA02-9	9	5/16"	1/4" BSPT	1/4" BSPT	81.95



Gesloten kunststof veerslanghaspels - perslucht & water

- Gewapende PVC slang.
- Sterke slagvaste polypropyleen constructie
- 180° swivel.
- Automatisch oprolmechanisme.
- Mechanisme voor automatische vergrendeling van de slang op elke gewenste lengte.
- Lichtgewicht.
- Met draaggreep.

Maximale werkdruk: Perslucht: 17 bar

0800	L mtrs	-ID-	Inlet	Outlet	€
ZA04-10B	10	3/8"	1/4" BSPT	1/4" BSPT	106.10

Perslucht en water - 10 meter PVC slang ID 10mm



Maximale werkdruk: Perslucht: 15 bar

Perslucht en water - 15 meter PVC slang ID 10mm

0800	L mtrs	-ID-	Inlet	Outlet	€
ZA05-15	15	3/8"	1/4" BSPT	1/4" BSPT	145.90
ZA05-15-38	15	3/8"	3/8" BSPT	3/8" BSPT	149.45



Maximale werkdruk: Perslucht: 20 bar

Perslucht en water - 20 meter PVC slang ID 13mm

0800	L mtrs	-ID-	Inlet	Outlet	€
ZA05-20B	20	1/2"	1/2" BSPT	3/8" BSPT	224.50
ZA05-20B-12	20	1/2"	1/2" BSPT	1/2" BSPT	229.95



Open metalen veerslanghaspels

- Zwaar geribbd plaatstaal
- Stabiliteit door gecentreerde positie van de veer
- Vierrichting geleiders verminderen slangslijtage



Maximale werkdruk:
20 bar

Tech Data
10183



Perslucht - 15 meter rubber slang ID 10mm of zonder slang

0800



SAHR-15-38 15m slang ID 3/8" - 3/8" BSPT aansl. **244.20**
SAHR-15N-38 Zonder slang - capaciteit 15m slang ID 3/8" **221.95**

- Verstelbare geleidingsarm waardoor verschillende montageposities mogelijk zijn
- Swivel met kogellager voor frictievermindering

Tech Data
10184

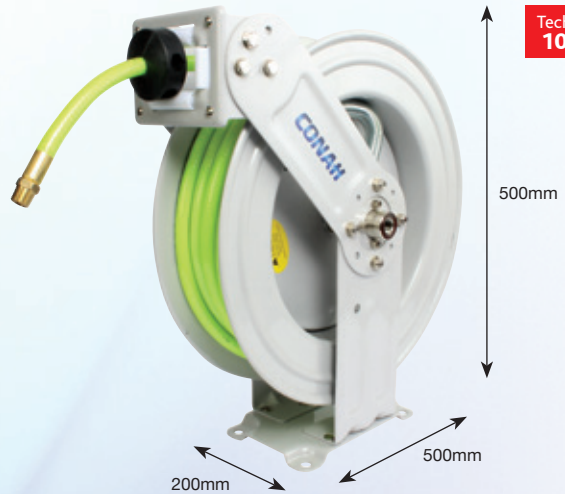

Perslucht en water - 15 meter Hi-Vis PVC slang ID 10mm

0800



SAHR-15-38SHV06T 15m slang ID 3/8" - 3/8" BSPT male aansl. **297.20**



Draaibare montageplaat t.b.v. SAHR-15-38

0800

To Suit



SAHR-15-38-SB SAHR-15-38 **28.20**



Draaibare montageplaat t.b.v. SAHR-15-12

0800

To Suit



SAHR-15-12-SB SAHR-15-12 **34.70**

Tech Data
10188



Perslucht en water - 15 meter Rubber Tech slang ID 10mm

0800



SAHR-15-38SRT06F 15m slang ID 3/8" - 3/8" BSP female aansl. **307.85**

Open metalen veerslanghaspels

- Zwaar geribbd plaatstaal
- Stabiliteit door gecentreerde positie van de veer
- Vierrichting geleiders verminderen slangslijtage

- Verstelbare geleidingsarm waardoor verschillende montageposities mogelijk zijn
- Swivel met kogellager voor frictievermindering

Tech Data
10185

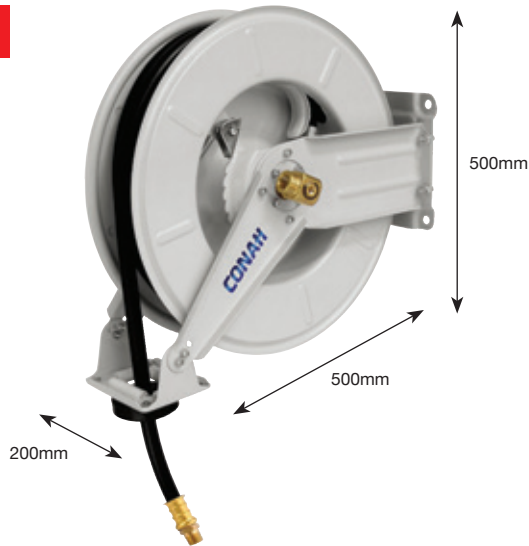

Perslucht - 15 meter rubber slang ID 13mm of zonder slang

0800		€
SAHR-15-12	15m slang ID 1/2" - 1/2" BSPT aansl.	361.45
SAHR-15N-12	Zonder slang - capaciteit 15m slang ID 1/2"	286.95

Maximale werkdruk:
28 bar

Tech Data
10187



Perslucht en water - 15 meter R6 slang ID 1/2"

0800		€
SAHR-15-12SR608F	15m slang ID 1/2" - 1/2" BSP female aansl.	420.35

Tech Data
10186



Perslucht en water - 20 meter Hi-Vis PVC slang ID 10mm

0800		€
SAHR-20-12SHV06T	20m slang ID 3/8" - 3/8" BSPT male aansl.	380.50

Tech Data
10195

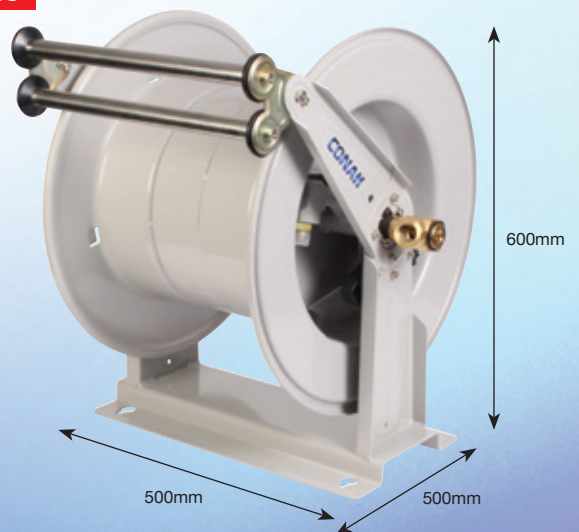

Zonder slang

0800		€
SAHR-40N-34	Zonder slang - capaciteit 40m slang ID 3/4"	943.95

Open metalen hogedruk veerslanghaspels

- Compact, geschikt voor gebruik bij toepassingen waar ruimte beperkt is
- Zware stalen constructie met corrosiebestendige poedercoating
- Vierrichting geleiders verminderen slangslijtage
- Multipositieel palmechanisme en eenvoudige spanningsaanpassing
- Volledig gesloten en gesmeerde veer
- Swivel met volle doorlaat
- Verstelbare geleidingsarm waardoor verschillende montageposities mogelijk zijn

 **Maximale werkdruk:**
150 bar

Tech Data
10189



Water - 15 meter zwarte Jetwash
R1 slang ID 3/8" of zonder slang

0800



SWHR-15-38 15m slang ID 3/8" - 3/8" BSP inl. - M22x1.5 uitl. **427.20**
SWHR-15N-38 Zonder slang - capaciteit 15m R1 slang ID 3/8" **348.70**

 **Maximale werkdruk:**
150 bar

Tech Data
10190

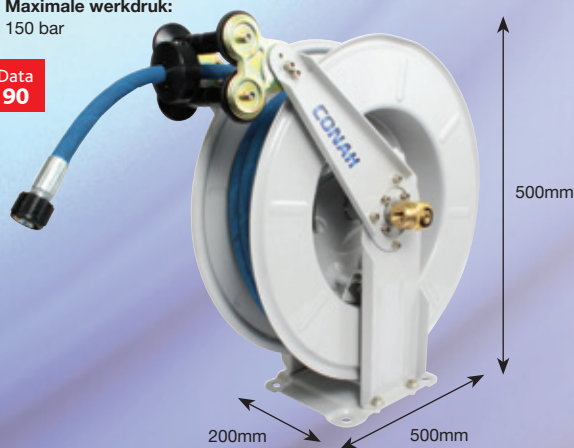

Water - 15 meter blauwe Jetwash
R1 slang ID 3/8"

0800



SWHR-15-38SB122K 15m slang ID 3/8" - M22x1.5 female aansl. **471.25**

Open metalen hogedruk slanghaspels - manueel

- Zware stalen constructie met corrosiebestendige poedercoating.
- Vierrichting geleiders verminderen slangslijtage
- Multipositieel palmechanisme en eenvoudige spanningsaanpassing
- Swivel met volle doorlaat
- Verschillende montageposities mogelijk

 **Maximale werkdruk:**
270 bar

Tech Data
10191



Water - 30 meter blauwe Jetwash
R2 slang ID 3/8"

0800



SWHR-30-38MB222K 30m slang ID 3/8" - M22x1.5 female aansl. **581.65**

 **Maximale werkdruk:**
270 bar

Tech Data
10192



Water - 30 meter zwarte Jetwash
R2 slang ID 3/8" of zonder slang

0800



SWHR-30-38 30m slang ID 3/8" - M22x1.5 aansl. **462.50**
SWHR-30N-38 Zonder slang - capaciteit 30m R2 slang ID 3/8" **224.70**

Half open veerslanghaspel

- Geschikt voor perslucht
- Geschikt voor wand-, vloer- of plafondmontage
- Rubberen slangnok voorkomt krassen op gevoelige oppervlaktes

Huis: kunststof
Slang: PU slang



Maximale
werkdruk:
8 bar

Tech Data
20340



Perslucht - 6 meter gewapende PU slang
ID 6,5mm - 1/4" aansluiting

27001307	9,5/6,5 x 1/4"	6	Beige	210	60	77.15

Open slanghaspel - manueel

- Geschikt voor perslucht & water
- Met inklapbare handgreep
- 360° draaibare wissel
- Zeer slagvast en knikvrij

Huis: metaal gecoat huis
Slang: hoge kwaliteit slijtvaste en knikvrije PU slang met textielinlage



Maximale
werkdruk:
14 bar

Tech Data
20342



Perslucht en water - 30 meter gewapende PU slang
ID 8mm - 1/4" aansluiting

27001730	12/8 X 1/4"	30	Rood	330	260	156.20

Gesloten veerslanghaspel

Tech Data
20339



Perslucht - 10 meter PU slang ID 8mm - 1/4" aansluiting

HR-1033	Nw-10 x 1/4"	10	Geel	12	227.60

- **tst** (drukknop) snelkoppelingen & insteeknippels vanaf pagina 257



PR serie slangenwagen - manueel

Voor het verplaatsen van zware en lange stukken slang met minimale inspanning.

- Alle swivels zijn 90°, de interne delen die in contact komen met het medium zijn bestand tegen een temperatuur van -25°C tot +100°C
- Zware dikwandige geheel stalen constructie met poedercoating.
- Een volstrekt stalen borgpen - voorkomt dat de trommel draait tijdens het verplaatsen van de wagen.
- Afneembare handgreep - voor compacte opslag en verzending.
- Massieve rubber banden.
- Stalen poten met rubber voetjes - voorkomt het wegglijden van de wagen bij het uittrekken van de slang.
- Instelbare vergrendeling - voorkomt terugslag van de slang bij het afrollen.



Zonder slang

0122



PRL-4-200 Zonder slang - capaciteit 60m slang ID 1/2" 1/2" **868.45**

Perslucht en water - 60 meter gewapende rubber slang ID 1/2"

0122



PRL-4-200-AW 60m slang ID 12.5mm **1031.85**

Alba Star serie 2 slangenwagen - heavy duty

- Robuuste stalen constructie.
- Verzinkt ter bescherming tegen corrosie.
- Grote trommeldiameter voorkomt het knikken van de slang.
- Brede rubber wielen voor extra mobiliteit.
- Trommelvergrendeling voorkomt het afrollen van de slang bij het verplaatsen.
- Swivels met volle doorlaat

Slangcapaciteit haspel:

- 1/2" (13mm) - 120 meter
- 5/8" (16mm) - 100 meter
- 3/4" (19mm) - 80 meter
- 1" (25mm) - 50 meter



Gegalvaniseerd - zonder slang

0122



AK1980 3/4" **409.40**

DM serie "Dolly" slangenwagen - manueel

Voorkomt overmatige inspanning en vermoeidheid bij het manueel oprollen van slangen. Bespaar tijd en verhoog productiviteit door efficiëntere verplaatsing van de slang.

- Geheel stalen constructie.
- Heavy duty 1"- 1.1/4" buisframe.
- Afneembare handgreep voor compacte opslag en verzending.
- Stevige 8 "rubber banden.
- Rubber voetjes - voorkomt het wegglijden van de wagen bij het uittrekken van de slang.
- Instelbare vergrendeling - voorkomt terugslag van de slang bij het afrollen.



Zonder slang

0122



117L-3-200DM Zonder slang - capaciteit 60m slang ID 1/2" 3/8" **575.35**
117L-4-225DM Zonder slang - capaciteit 70m slang ID 1/2" 1/2" **669.10**

Alba Profi slangenwagen - heavy duty

- Extreem robuuste stalen constructie.
- Thermisch verzinkt ter bescherming tegen corrosie in de meest barre omstandigheden.
- Grote trommeldiameter voorkomt het knikken van de slang.
- Brede, pneumatische rubber wielen voor extra mobiliteit.
- Trommelvergrendeling voorkomt het afrollen van de slang bij het verplaatsen.
- Zeer stabiele rubber voetjes - voorkomt het wegglijden van de wagen bij het uittrekken van de slang.

Slangcapaciteit haspel:
 5/8" (16mm) - 150 meter
 3/4" (19mm) - 120 meter
 1" (25mm) - 80 meter



Gegalvaniseerd - zonder slang

0122



AK2580 1" **686.65**

KELM™ pneumatiek
Hydrauliek
Snelkoppelingen
Afsluiters
Roestvast staal
Fittingen
Luchtconditionering
Gereedschap
Pneumatiek
Diversen
Malleabele fittingen & staal
Ringleidingssystemen
Slangen
Compressoren

Retracta gesloten veerslanghaspels

De Redashe Retracta veerslanghaspels bieden betrouwbaarheid, kwaliteit en veelzijdigheid. Het huis is gemaakt slagvast UV-bestendig polypropyleen en daardoor zeer duurzaam. Geschikt voor zowel binnen- als buitentoepassingen. In het bijzonder geschikt voor reinigingstoepassingen in de voedingsindustrie, als alternatief voor de conventionele RVS haspels. Geschikt voor wand-, vloer- en overheadmontage.



Productdetails:

- Met vergrendelingsfunctie zodat dat de haspel in alle mogelijke posities gemonteerd kan worden
- Slang kan vergrendeld worden op elke gewenste lengte
- Sterke corrosiebestendige constructie van slagvast UV-bestendig polypropyleen
- Lichtgewicht (12kg) en makkelijk te installeren
- Volledig automatisch oprolmechanisme
- Lage rolweerstand waardoor de slang makkelijk uittrekbaar is
- Zeer onderhoudsarm
- Reserveonderdelen zijn verkrijgbaar
- 5 jaar fabrieksgarantie (onder voorwaarden)

N.B.: Leverbaar voor veel andere toepassingen, met of zonder slang.

Perslucht - 20 meter gewapende PVC slang ID 10mm

0122							€
AR100	20	10	3/8" female	1/4" male	16	Rood	514.25

Perslucht - 15 meter gewapende PVC slang ID 12,5mm

0122							€
AR200	15	12.5	3/8" female	3/8" male	16	Rood	554.75

Koud water (max. 40°C) - 15 meter gewapende PVC slang ID 12,5mm

0122							€
CW100	15	12.5	3/8" female	Slang	10	Blauw	622.70

Heet water (max. 90°C) - 12 meter gewapende rubber slang ID 12,5mm

0122							€
HW100	12	12.5	3/8" female	3/8" male	10	Rood	712.40

Heet water FOOD (max. 95°C) - 12 meter gewapende rubber slang ID 12,5mm

0122							€
FQ100	12	12.5	3/8" female	1/2" male	20	Rood	752.25

Tuinhaspel - 18 meter PVC slang ID 12,5mm

0122							€
DR100	18	12.5	3/4" male	Nozzle	7	Groen	454.75

Ademlucht EN139 - 15 meter gewapende NBR/PVC slang ID 10mm

0122							€
BH100	15	10	3/8" female	3/8" male	12	Rood	778.90

Reelworks 701/705 gesloten veerslanghaspels

Productdetails:

- Geschikt voor water en perslucht
- Lichtgewicht (5.7kg) en duurzaam
- Huis van slagvast UV-bestendig polypropyleen
- Standaard geleverd met PVC slang voor direct gebruik
- Compleet geassembleerd
- Geïntegreerde montagebeugel voor wand- en overheadmontage
- Slang kan vergrendeld worden op elke gewenste lengte
- Volledig automatisch oprolmechanisme
- Zeer onderhoudsarm
- 12 maanden fabrieksgarantie (onder voorwaarden)

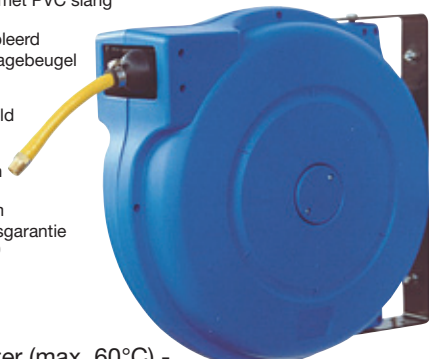

Perslucht en water (max. 60°C) - diverse lengtes en maten PVC slang

0122	L m	ID mm	BSPT	bar	Slang	€
C705-100	10	1/4"	1/4"	12	Blauw Zwart	156.50
C705-200	8	5/16"	1/4"	12	Blauw Zwart	164.55
C701-100	15	3/8"	3/8"	20	Blauw Geel	228.70
C701-200	15	1/2"	1/2"	20	Blauw Geel	248.80

Reelworks 808 open veerslanghaspels

Productdetails:

- Geschikt voor perslucht en water (lage en medium druk)
- Huis van zwaar plaatstaal met corrosiebestendige poedercoating
- Met geleidingsarm, verstelbaar in 4 posities
- De veer is volledig ingesloten en gesmeerd
- Slang kan vergrendeld worden op elke gewenste lengte
- Geschikt voor wand-, plafond-, overhead- of vloerinstallatie



Perslucht en water - 15 meter slang ID 10mm of 12.5mm

0122	L m	ID mm	BSPT	bar	€
C808-350L	15	3/8"	3/8"	20	397.35
C808-450L	15	1/2"	1/2"	20	457.55
C808-350M	15	3/8"	3/8"	155	539.80
C808-450M	15	1/2"	1/2"	138	600.00

Reelworks 208 open slanghaspels - manueel

Productdetails:

- Vervaardigd uit tubulair en gevormd staal voor superieure sterkte en duurzaamheid
- Zwarte corrosiebestendige poedercoating
- De draaibare messing aansluiting heeft een volle doorlaat en zorgt voor een maximale flow.
- Geschikt voor wand-, vloerwerkbankmontage, ideaal voor mobiele applicaties
- De borgpen met veer voorkomt dat de slang van de haspel kan gaan
- Lichtgewicht (7,5kg zonder slang)
- Maximale werkdruk haspel: 200 bar



Zonder slang

0122	Inlaat	Uitlaat	€
C208-3-100H	Capaciteit 30m slang ID 10mm	3/8" 3/8"	202.70
C208-4-65H	Capaciteit 20m slang ID 12,5mm	1/2" 1/2"	198.70

Reelworks 460 open slanghaspels - manueel

Productdetails:

- Ontworpen voor industriële applicaties waar langere slanglengtes vereist zijn
- Huis van zwaar plaatstaal met poedercoating
- De draaibare aansluiting heeft een volle doorlaat en zorgt voor maximale flow
- De borgpen met veer voorkomt dat de slang van de haspel kan gaan
- Geschikt voor wand-, plafond-, overhead- of vloerinstallatie
- Maximale werkdruk haspel: 200 bar



Zonder slang

0122	Inlaat	Uitlaat	€
C460-3-350H	Capaciteit 105m slang ID 10mm	3/8" 3/8"	288.95
C460-4-270H	Capaciteit 80m slang ID 12,5mm	1/2" 1/2"	285.00

Type MP/MN/MD gesloten veerslanghaspels

Toepassing: Perslucht

Levering: Compleet met 180° draaibare bevestiging. Geschikt voor wand- en plafondmontage. Andere kleuren/slanguitvoeringen zijn op aanvraag leverbaar.

Functies: Automatische terugloop, blokkeerstanden op de gewenste slanglengte. De professionele draaibare inlaatkoppeling zorgt voor perfecte dichting en soepel draaiwerk. De swivels zijn per uitvoering voorzien van verschillende dichtingen, aangepast aan het medium en de toepassing. Deze Faicom swivels zijn ook los verkrijgbaar, zie verderop in dit hoofdstuk.

Kwaliteit: Industriële kwaliteit. Geproduceerd en getest in de EU, 2 jaar garantie.

Materiaal: **Haspel:** Plaatstaal, in en uitwendig bad verzinkt en epoxy gecoat. UV bestendig.
Onderdelen die in contact komen met het medium zijn extra tegen corrosie behandeld.

Temperatuur:
Tot 40°C

Maximale werkdruk:
Tot 20 bar



MP20-SERIE



27021710



27021712

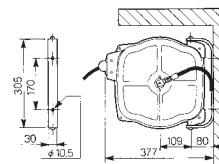
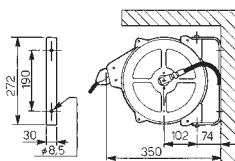
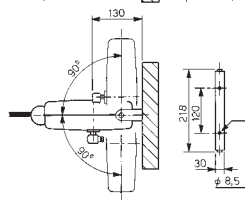
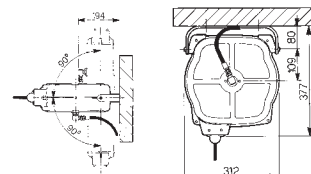
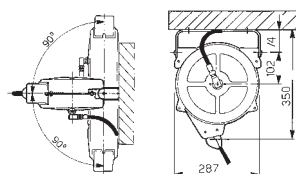
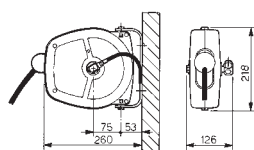

Perslucht - diverse lengtes en maten gewapende PU slang

MP200805		Type MP20	Blauw	5	3	1/4" BSP male	PU 11x8 BSP	PU 11x8	181.80
MP201003		Type MP20	Blauw	3	3	3/8" BSP male	PU 14x10 BSP	PU 14x10	191.35
27021710		Type MN20	Rood	10	8	1/4" BSP male	3/8" BSP female	PU 12x8	273.30
27021712		Type MD20	Blauw	12	9	1/4" BSP male	3/8" BSP female	PU 12x8	329.40

• **Voor drukknop veiligheidsnelkoppelingen conform ARB0/ISO 4414 zie pagina 257 en 262**

• **Met Euro, Orion & ISO 6150-C profiel**



Slanghaspels



FAICOM
ITALY

Type AM open slanghaspels - manueel

Toepassingen: Perslucht en water.

Levering: Verkrijgbaar met en zonder polyester versterkte PU slang. Inclusief 2 meter aansluitslang. De bevestigingsgaten \varnothing 8.5 maken wandmontage mogelijk.

Functie: Inklapbare handel. Ruimtebesparende goedkope oplossing. Geen rondslingerende slangen. Veilig.

Kwaliteit: Deze slanghaspel is van uitstekende kwaliteit. Geproduceerd en getest in de EU, 2 jaar garantie.

Materiaal: **Buizenframe:** Elektrostatisch polyester gecoat, krasvast en UV bestendig.

Haspel: Het plaatstaal is in- en uitwendig badverzinkt.

Temperatuur:
Tot 40°C

Maximale werkdruk:
Tot 20 bar

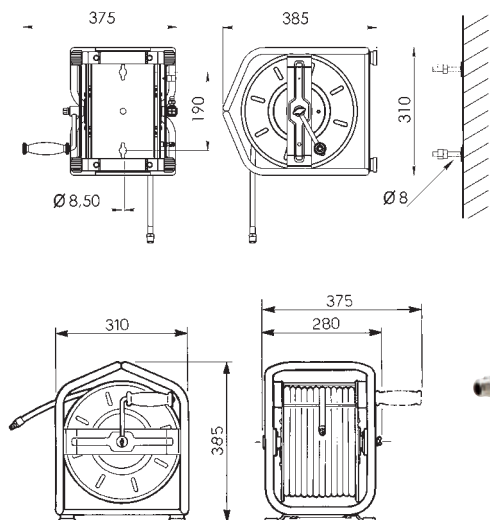

Perslucht - diverse lengtes en maten gewapende PU slang

VEER	-m-		Uitlaat	Inlaat	Slang	€
AM2010ST	Zonder slang	5.5	1/4" BSP male	1/4" BSP female	Geen	146.15
AM200830	30	8.4	1/4" BSP male	1/4" BSP male	TPU 12x8	199.55
AM200840	40	9	1/4" BSP male	1/4" BSP male	TPU 12x8	224.20
AM201025	25	8.4	3/8" BSP male	3/8" BSP male	TPU 14x10	217.35

Hoofdstuk 13 - Slangen

KELM™
pneumatiek

Hydrauliek

Snel-
koppelingen

Atsluiters

Roestvast
staal

Fittingen

Lucht-
conditionering

Gereedschap

Pneumatiek

Diversen

Malleabele
fittingen
& staal

Ringleiding-
systemen

Slangen

Compressoren

- **tst** (drukknop) snelkoppelingen & insteeknippels vanaf pagina 257



tst

Type MC industriële gesloten veerslanghaspels

Toepassingen: Geschikt voor perslucht, water (heet en koud), olie en vet.

Levering: Andere slangen (lengtes en maten) zijn op aanvraag leverbaar. Standaard levering met vaste bevestiging. Geschikt voor wand- en plafondmontage. Levering exclusief aansluitslang. Voor 180° draaibare bevestigingsbeugel (26061099L) en aansluitslang zie Faicom accessoires.

Functies: Automatische terugloop, met blokkeerstanden op de gewenste slanglengtes. De professionele draaibare inlaatkoppeling zorgt voor perfecte dichting en soepel draaiwerk. De swivels zijn per uitvoering voorzien van verschillende dichtingen, aangepast aan het medium en de toepassing. Faicom swivels zijn los verkrijgbaar, zie Faicom accessoires.

Kwaliteit: Industriële kwaliteit. Geproduceerd en getest in de EU, 2 jaar garantie.

Materiaal: **Haspel:** Plaatstaal is in en uitwendig bad verzinkt en epoxy gecoat. UV bestendig. Onderdelen die in contact komen met het medium zijn extra tegen corrosie behandeld. Op aanvraag in andere kleuren leverbaar.

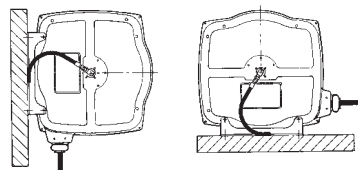
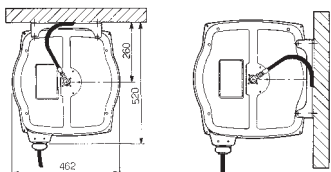
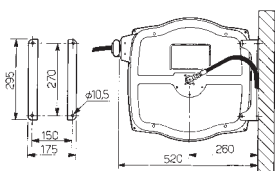

KELM™
pneumatiek

Hydrauliek

Snel-
koppelingen

Afsluiters

Roestvast
staal

Fittingen

Lucht-
conditionering

Gereedschap

Pneumatiek

Diversen

Malleabele
fittingen
& staal

Ringleiding-
systemen



Slangen

Compressoren

 **Temperatuur:**
Tot 40°C

 **Maximale
werkdruk:**
Tot 18 bar



Perslucht en water - type MC18 - diverse lengtes en maten SAE 100R6 slang

	VEER	 -m-		Uitlaat	Inlaat	Slang	€
27031710	10	20	20	3/8" BSP male	3/8" BSP female	14x8	482.50
27031715	15	20	20	3/8" BSP male	3/8" BSP female	14x8	531.70
27031720	20	20	20	3/8" BSP male	3/8" BSP female	14x8	582.30
27031810	10	20	20	3/8" BSP male	3/8" BSP female	17x10	490.70
27031815	15	20	20	3/8" BSP male	3/8" BSP female	17x10	546.70
27032110	10	20	20	1/2" BSP male	1/2" BSP male	20x13	571.35

 **Temperatuur:**
Tot 40°C

 **Maximale
werkdruk:**
Tot 20 bar

Perslucht - type MC20 - diverse lengtes en maten gewapende PU slang

	VEER	 -m-		Uitlaat	Inlaat	Slang	€
27030820PU	20	20	20	3/8" BSP male	3/8" BSP female	PU 12x8	561.80
27031020PU	20	20	20	3/8" BSP male	3/8" BSP female	PU 14x10	582.30
27031315PU	15	20	20	1/2" BSP male	1/2" BSP male	PU 18x13	627.50

Type V industriële open veerslanghaspels

Toepassingen: Perslucht, water (heet en koud), olie en vet.

Levering: Met vaste bevestiging. Voor 140° draaibare beugelsets (26071099S), zie Faicom accessoires.

Functies: In 3 verschillende standen fixeerbare slanggeleider met 2 rollen. Met automatische blokkeerinrichting.

Kwaliteit: Zware industriële kwaliteit. Geproduceerd en getest in de EU, 2 jaar garantie.

Materiaal: **Haspel:** Plaatstaal is in- en uitwendig badverzinkt & epoxy gecoat. UV bestendig. Onderdelen die in contact komen met het medium zijn extra tegen corrosie behandeld.

Temperatuur:
Tot 40°C

**Maximale
werkdruk:**
Tot 18 bar

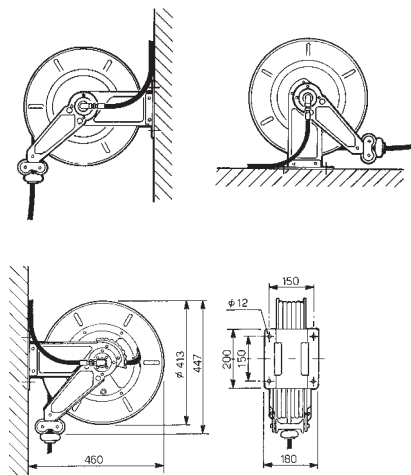

Perslucht en water - type V18 - diverse lengtes en maten SAE 100R6 slang

VEER	m	kg	Uitlaat	Inlaat	Slang	€
27071710VS	10	20	3/8" BSP male	3/8" BSP female	14x8	482.50
27071715VS	15	20	3/8" BSP male	3/8" BSP female	14x8	531.70
27071720VS	20	20	3/8" BSP male	3/8" BSP female	14x8	582.30
27071820VS	20	20	3/8" BSP male	3/8" BSP female	17x10	582.30
27071815VS	15	20	1/2" BSP male	1/2" BSP male	20x13	620.50

KELM™
pneumatiek

Hydrauliek

Snel-
koppelingen

Atsluiters

Roestvast
staal

Fittingen

Lucht-
conditionering

Gereedschap

Pneumatiek

Diversen

Malleabele
fittingen
& staal

Ringleiding-
systemen

Slangen

Compressoren

Type VX industriële open RVS veerslanghaspels

Toepassingen: Geschikt voor perslucht en heet water. Toepasbaar in o.a. farmaceutische industrie, slachterijen, melkveehouderij, grootkeukens, laboratoria, levensmiddelenindustrie & zwembaden.

Levering: Koppelingen met beschermmof. Standaard levering met vaste RVS bevestiging. Geschikt voor wand- en plafondmontage. Voor 140° draaibare RVS beugel (AXSG15) zie Faicom accessoires.

Functies: Automatische terugloop, met blokkeerstanden op de gewenste slanglengtes. De professionele RVS draaibare inlaatkoppeling zorgt voor perfecte dichting en soepel draaiwerk. De swivel is voorzien van speciale dichtingen, aangepast aan de werkdruk en het medium.

Kwaliteit: Zware industriële FOOD kwaliteit. Geproduceerd en getest in de EU, 2 jaar garantie.

Materiaal: **Haspel:** RVS AISI-304. Plaatmateriaal, bevestigingstechniek en draadelen van RVS en/of chemisch vernikkeld.

Afmetingen: Zie de technische tekeningen op de vorige pagina.



RVS

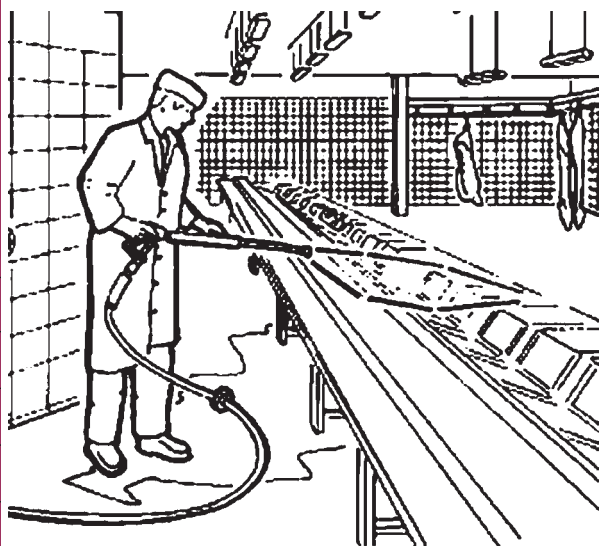

KELM™
pneumatiek

Hydrauliek

Snel-
koppelingen

Afsluiters

Roestvast
staal

Fittingen

Lucht-
conditionering

Gereedschap

Pneumatiek

Diversen

Malleabele
fittingen
& staal

Ringleiding-
systemen

Slangen

Compressoren

Perslucht & water (hoge- en lagedruk) - 15 meter Thermoplastic Blue rubber slang in diverse maten

	VEER	- m -	bar	°C	kg	Uitlaat	Inlaat	Slang	€
VX101315K		15m	10	80	20	1/2" BSP male	1/2" BSP male	ID 13mm	1025.10
VX4H3815		15m	400	150	20	3/8" BSP male	3/8" BSP female	ID 9,5mm	1133.20
VX4H5115		15m	400	150	20	3/8" BSP male	3/8" BSP female	ID 8mm	1145.35

Slanghaspels

Type VL breed model open veerslanghaspels

- Toepassingen:** Perslucht, water (heet en koud), olie e.d.
Levering: Standaard met vaste bevestiging. Voor beugelset 140° draaibaar (27071009L), zie Faicom accessoires.
Functionies: Drie verschillende standen. Fixeerbare slanggeleider met 2 rollen.
Kwaliteit: Zware industriële kwaliteit. Geproduceerd en getest in de EU, 2 jaar garantie.
Materiaal: **Haspel:** Plaatstaal is in- en uitwendig badverzinkt & epoxy gecoat. UV bestendig. Onderdelen die in contact komen met het medium zijn extra tegen corrosie behandeld..

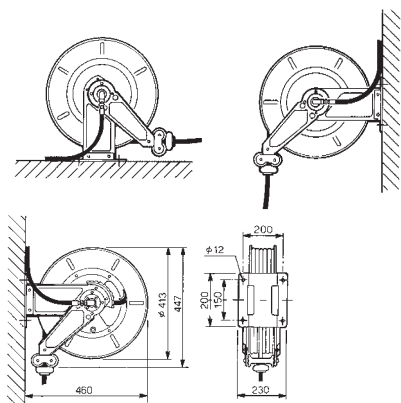

- Temperatuur:** Perslucht en water tot 40°C
Maximale werkdruk: Tot 18 bar

Perslucht en water - type VL18 - 25 meter SAE 100R6 rubber slang in diverse maten

VEER			Uitlaat	Inlaat	Slang	€
27071725VL	25	25	3/8" BSP male	3/8" BSP female	14x8	665.65
27071825VL	25	25	3/8" BSP male	3/8" BSP female	17x10	721.75

- Temperatuur:** Perslucht tot 40°C
Temperatuur: Perslucht tot 20 bar

Perslucht - type VL20 - 25 meter gewapende PU slang ID 13mm

VEER			Uitlaat	Inlaat	Slang	€
27071725PVL	25	25	1/2" BSP male	1/2" BSP male	PU 18x13	805.15

- Temperatuur:** Water en olie tot 40°C
Maximale werkdruk: Perslucht tot 60 bar

Olie en water - type VL60 - 20 meter LEANLINE rubber slang ID 1/2"

VEER			Uitlaat	Inlaat	Slang	€
27081720VL	20	25	1/2" BSP male	1/2" BSP male	ID 13mm	885.65

- Temperatuur:** Water tot 150°C
Maximale werkdruk: Tot 400 bar

Hogedruk water - type VL4H - 20 meter HOT WATER BLUE slang ID 3/8"

VEER			Uitlaat	Inlaat	Slang	€
27101720VL	20	25	3/8" male	3/8" female	ID 9,5mm	949.95

Slanghaspels



FAICOM
ITALY

Type VLX breed model open RVS veerslanghaspels

- Toepassingen:** Geschikt voor perslucht en heet water. Toepasbaar in o.a. farmaceutische industrie, slachterijen, melkveehouderij, grootkeukens, laboratoria, levensmiddelenindustrie & zwembaden.
- Levering:** Koppelingen met beschermmof. Standaard levering met vaste RVS bevestiging. Geschikt voor wand- en plafondmontage. Voor 140° draaibare RVS beugel (ALXSG20) zie Faicom accessoires.
- Functies:** Automatische terugloop, met blokkeerstanden op de gewenste slanglengtes. De professionele RVS draaibare inlaatkoppeling zorgt voor perfecte dichting en soepel draaiwerk. De swivel is voorzien van speciale dichtingen, aangepast aan de werkdruk en het medium. RVS swivels zijn los verkrijgbaar. Met een in 3 verschillende standen fixeerbare slanggeleider met 2 rollen.
- Kwaliteit:** Industriële FOOD kwaliteit. Geproduceerd en getest in de EU, 2 jaar garantie.
- Materiaal:**
Haspel: RVS AISI-304. Plaatmateriaal, bevestigingstechniek en draaidelen van RVS en/of chemisch vernikkeld.
Slang: Zeer slijtvaste industriële kwaliteit Thermoplastic Blue slang.
Afmetingen: Zie de technische tekeningen op de vorige pagina.



Slang: synthetisch rubber

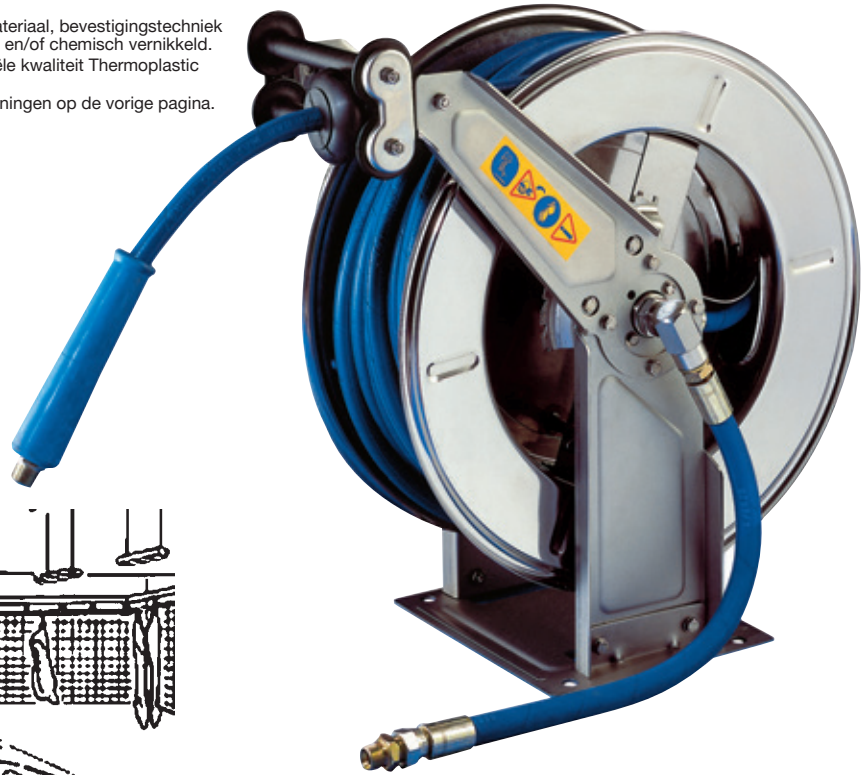

Hoofdstuk 13 - Slangen

KELM™
pneumatiek

Hydrauliek

Snel-
koppelingen

Afsluiters

Roestvast
staal

Fittingen

Lucht-
conditionering

Gereedschap

Pneumatiek

Diversen

Malleabele
fittingen &
staal

Ringleiding-
systemen

Slangen

Compressoren

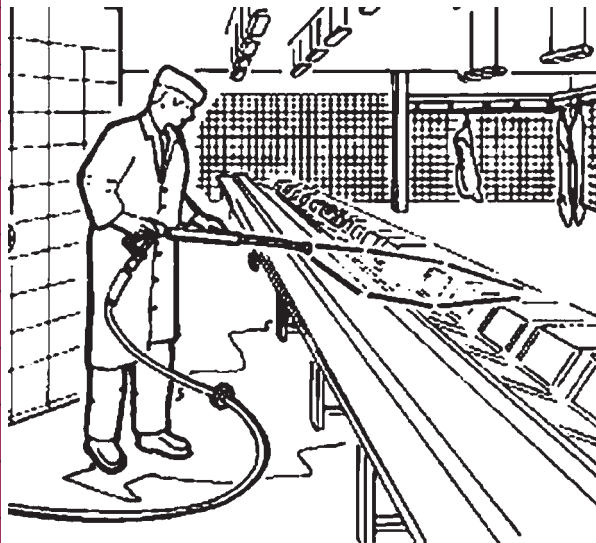

Water - 20 meter Thermoplastic Blue rubber slang in diverse maten

	VEER	bar	°C	-m-	kg	Uitlaat	Inlaat	Slang	€
VLX101320K		10	80	20	20	1/2" male	1/2" male	21x13	1290.35
VLX4H3820		400	150	20	20	3/8" male	3/8" female	ID 9,5mm	1459.85
VLX4H5120		400	150	20	20	3/8" male	3/8" female	ID 8mm	1444.90

Montageplaten

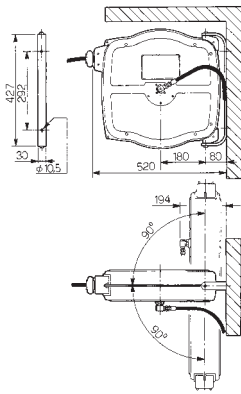

26061099L & MCXSG10



26071099S & AXSG15

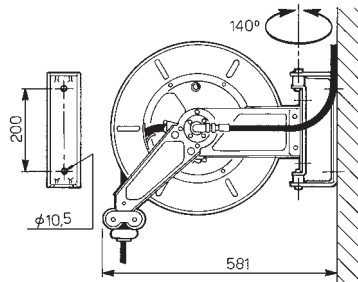

27071099L & ALXSG20

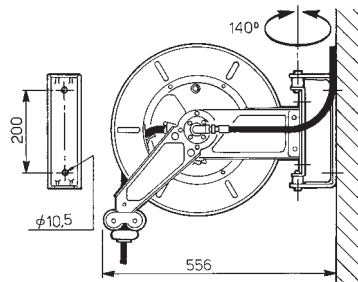

Draibare montageplaat voor industriële slanghaspels



26061099L	MCXSG10 180° t.b.v. type MC haspel	28.30
MCXSG10	MCXSG10 180° (RVS) t.b.v. type MCX haspel	69.80
26071099S	ASG15 140° t.b.v. type V haspel	37.40
AXSG15	AXSG15 140° (RVS) t.b.v. type VX haspel	86.45
27071099L	ALSG20 140° t.b.v. type VL haspel	41.85
ALXSG20	ALXSG20 140° (RVS) t.b.v. type VLX haspel	80.15



Vaste montageplaat voor slanghaspel type MC



MCCS10



28.30

Afsluitdeksels



Voor zijkant van slanghaspels type V, VL, VX en VLX



VCAR



Beschermkap haspels



37.65

Slangstoppers



Voor industriële veerslanghaspels



342	11mm	10.45
127	12mm	10.45
0022A	14mm (1/4")	16.50
0022B	17mm (3/8")	16.50
0022C	20mm (1/2")	16.50
0022E	23mm (5/8")	19.70
0022F	27mm (3/4")	19.70
0022G	33mm (1")	19.70

KELM™
pneumatiek

Hydrauliek

Snel-
koppelingen

Atsluiters

Roestvast
staal

Fittingen

Lucht-
conditionering

Gereedschap

Pneumatiek

Diversen

Malleabele
fittingen
& staal

Ringleiding-
systemen

Slangen

Compressoren

Swivels



0065A 0065D 0066A
0066A1 0066B

90° swivels voor industriële slanghaspels - verzinkt staal

VEER	Type	BSPP	bar	Seal	€
0065A	65A - perslucht, water, olie	3/8" female	60 bar	PU	23.00
0065D	65D - perslucht, water, olie	1/2" male	60 bar	PU	27.65
0066A	66A - olie	1/4" female	400 bar	NBR/PTFE	44.30
0066A1	66A1 - olie	3/8" female	400 bar	NBR/PTFE	44.30
0066B	66B - water 150°C	3/8" female	400 bar	SIL/PTFE	44.30

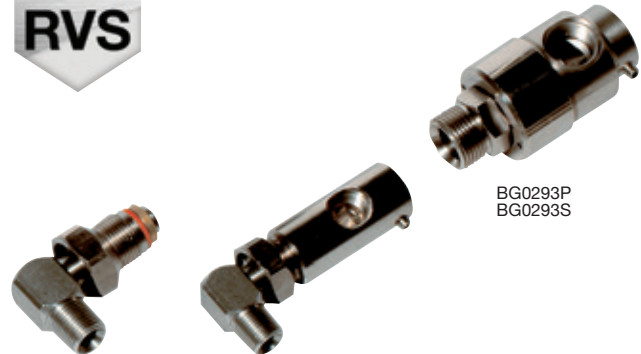

0238X BG0238CPL

BG0293P
BG0293S

Swivels voor industriële slanghaspels type BG en BGX - RVS

VEER	Type	Uitlaat	Inlaat	bar	Seal	€
0238X	238X - water 150°C	1/2" female	1/2" male	400 bar	SIL/PTFE	118.50



0065CX 0066BX

90° swivels voor industriële RVS slanghaspels - RVS

VEER	Type	BSPP	bar	Seal	€
0065CX	65CX - water 100°C	1/2" male	60 bar	NBR	68.85
0066BX	66BX - water 150°C	3/8" female	400 bar	SIL/PTFE	68.85

Swivels voor industriële slanghaspels type BG en BGX - chemisch vernikkeld staal

VEER	Type	Uitlaat	Inlaat	bar	Seal	€
BG0238CPL	water 150°C	1/2" female	1/2" male	400 bar	SIL/PTFE	178.60
BG0293P	perslucht, water, olie	3/4" female	1" male	60 bar	PU	178.60
BG0293S	water 150°C	3/4" female	1" male	60 bar	SIL/PTFE	178.60



Aansluit slang

Met koppelingen voor industriële slanghaspels - lengte 0,5 meter

VEER		bar	°C	To Suit	Uitlaat	Inlaat	€
TC08005	Slang 14x8 (5/16" SAE100R6)	18	40	MC, A, AL, V, VL	3/8" BSP female	3/8" BSP male	18.55
TC10005	Slang 17x10 (3/8" SAE100R6)	18	40	MC, A, AL, V, VL	3/8" BSP female	3/8" BSP male	18.55
TC13005	Slang 20x13 (1/2" SAE100R6)	18	40	MC, A, AL, V, VL	1/2" BSP female	1/2" BSP female	29.00
TC38005	Slang ID 9,5mm (3/8" EN857 1SC)	60	40	MC, A, AL, V, VL	3/8" BSP male	3/8" BSP female	24.90
TC12005	Slang ID 13mm (1/2" Leanline)	60	40	MC, A, AL, V, VL	1/2" BSP female	1/2" BSP female	25.10
TC14005	Slang ID 6,35mm (1/4" EN853 2SN)	400	40	MC, A, AL, V, VL	1/4" BSP male	1/4" BSP female	19.10
TC13005K	Slang ID 13mm (Thermoplastic Blue)	12	80	MCX, AX, ALX, VX, VLX	1/2" BSP female	1/2" BSP female	23.65
TC38005H	Slang ID 9,5mm (3/8" HOT WATER BLUE)	400	150	MCX, AX, ALX, VX, VLX	3/8" BSP male	3/8" BSP female	23.65

Slanghaspels

804 gesloten veerslanghaspels

Huis: Slagvast ABS kunststof

Slang: Gladde versterkte soepele KPU slang met grote doorlaat. Nippel met buitendraad en anti-knikveer. Metalen zwenkbare muurbeugel. Automatische blokkeerinrichting elke 50 cm. naar keuze in- of uit te schakelen.

Temperatuur: -5°C tot +40°C
Maximale werkdruk: 15 bar

Perslucht en water - 9 meter gewapende KPU slang ID 8mm

27001306	1/4"	8	9+1	GRIJS	310	125	290.40



813 gesloten veerslanghaspels

Huis: Epoxy gelakt aluminium spuitgietwerk.

Slang: Soepele versterkte PVC slang met polyurethaan binnenslang met grote doorlaat. Nippel met buitendraad en anti-knikveer. Metalen zwenkbare muurbeugel. Automatische blokkeerinrichting elke 50 cm. naar keuze in- of uit te schakelen

Temperatuur: -5°C tot +40°C
Maximale werkdruk: 15 bar

Perslucht en water - 10 meter gewapende PVC slang ID 8mm

27001310	1/4"	8	10+2	GRIJS	360	175	517.70

Perslucht en water - 7 meter gewapende PVC slang ID 10mm

27001707	3/8"	10	7+2	GRIJS	360	175	518.85



805 gesloten veerslanghaspels

Huis: Slagvast ABS kunststof

Slang: Gladde versterkte soepele KPU slang met grote doorlaat. Nippel met buitendraad en anti-knikveer. Metalen zwenkbare muurbeugel. Automatische blokkeerinrichting elke 50 cm. naar keuze in en uit te schakelen.

Plafondmontage mogelijk met ombouwkit 949/805-7000

Temperatuur: -5°C tot +40°C
Maximale werkdruk: 15 bar

Perslucht en water - 15 meter gewapende KPU slang ID 8mm

ZH805/8/S	1/4"	8	15+1	Grijs	380	205	265.70

Perslucht en water - 15 meter gewapende KPU slang ID 10mm

ZH805/10/S	3/8"	10	15+1	Grijs	380	205	280.05



- KELM™ pneumatiek
- Hydrauliek
- Snelkoppelingen
- Atsluiters
- Roestvast staal
- Fittingen
- Luchtconditionering
- Gereedschap
- Pneumatiek
- Diversen
- Malleabele fittingen & staal
- Ringleidingssystemen
- Slangen
- Compressoren

Slanghaspels



Industriële veerkabelhaspels met een moderne vormgeving
Slijtvaste PVC (Ho5VV-F) kabel. Voorzien van dubbele aarding. Huis van slagvast kunststof en met twee geleiderollen. Met automatische blokkering op iedere 50 cm.

Beschermklasse: IP42.

Wordt geleverd compleet met zwenkbeugel voor wandmontage
Alle gele haspels t/m 3-aderig hebben een thermische beveiliging.

4000/7000 serie veerkabelhaspel - 12/24/230V



gele uitvoering is serie 4000

12, 24 en 230 Volt - diverse lengtes slijtvaste PVC kabel

ZVEE	Aderig	Dia Ader			KW OP	KW AF	€
ZH4315	3	1,5	Geel	14+1	1,2 Kw	1,8 Kw	244.90
ZH4325	3	2,5	Geel	9+1	1,9 Kw	2,5 Kw	255.35
ZH7315	3	1,5	Grijs	25+2	1,1 Kw	1,8 Kw	426.95
ZH7325	3	2,5	Grijs	20+2	2,0 Kw	3,0 Kw	459.00

4000/7000 serie veerkabelhaspel - 400V



grijze uitvoering is serie 7000

400 Volt - diverse lengtes slijtvaste PVC kabel

ZVEE	Aderig	Dia Ader			KW OP	KW AF	€
ZH4415	4	1,5	Geel	10+1	1,4 Kw	1,9 Kw	266.85
ZH4515	5	1,5	Geel	8+1	1,4 Kw	1,9 Kw	288.20
ZH7415	4	1,5	Grijs	25+2	1,1 Kw	1,8 Kw	469.65
ZH7425	4	2,5	Grijs	18+2	2,0 Kw	3,0 Kw	480.35
ZH7525	5	2,5	Grijs	15+2	2,0 Kw	3,0 Kw	533.70

De haspels, serie 7000 (grijze uitvoering) worden standaard geleverd met de blokkering in stand "uit"
Plafondmontage mogelijk met ombouwkit 949/4000 (serie 4000) en 949/805-7000 (serie 7000)

- **tst** (drukknop) snelkoppelingen & insteeknippels vanaf pagina 257



Bestendigheidstabel

De chemische stoffen zijn bij de opgegeven temperaturen zorgvuldig onderzocht en daarna in de bestendigheidstabel geplaatst. Als er geen vermelding in de kolom staat zijn er geen testgegevens beschikbaar m.b.t. het desbetreffende materiaal.

Deze bestendigheidlijst dient als richtlijn. Wij zijn niet aansprakelijk voor schade die eventueel zou kunnen voortvloeien uit deze gegevens. Bij onduidelijkheid of vragen neemt u s.v.p. contact met ons op.

Tekstverklaring: bestendig = b beperkt bestendig = bb niet bestendig = n

Medium	Concentratie %	°C	PVC	PA	PU	PE	PPC	Vinnylan
Accuzuur	-	50	bb	bb	n	b	b	bb
Accuzuur	-	20	bb	bb	n	b	b	b
Aceton	100%	20	n	b	b	n	b	n
Acrylnitriet	100%	20	-	b	-	b	-	-
Afvalzouten	-	20	b	-	-	-	-	-
Afwasmiddel	-	20	b	-	-	-	b	-
Alcohol	96%	20	bb	-	-	-	b	-
Aluin	verdund	20	bb	-	-	-	b	b
Aluminiumchloride	verdund	23	-	-	-	b	b	b
Aluminiumhydroxide	geconcentreerd	23	-	-	-	b	b	-
Aluminiumsulfaat	10%	20	-	b	b	b	b	-
Ammoniak (gas)	100%	20	b	-	-	b	-	b
Ammoniak (in water)	geconcentreerd	-	-	-	-	-	-	b
Ammoniak (in water)	10%	20	b	-	-	b	b	b
Ammoniumacetaat (in water)	elke	20	b	-	-	-	b	b
Ammoniumchloride	10%	20	-	b	bb	b	b	b
Aniline	100%	23	n	bb	n	b	b	n
Antimoanchloride	verzadigd	23	-	-	-	b	b	-
Antivries	-	20	b	-	-	-	b	b
Arseenzuur	100%	23	-	-	-	b	b	-
Asfalt	-	20	bb	b	b	n	-	bb
Azijnzuur	98%	20	n	n	n	b	b	n
Azijnzuur	10%	20	-	b	b	b	b	b
Bakkersgist	-	20	b	-	-	-	-	-
Bariumcarbonaat	verzadigd	23	-	-	-	b	b	-
Bariumchloride	verzadigd	23	-	-	-	b	b	b
Bariumhydroxide	verzadigd	23	-	-	-	b	b	-
Bariumsulfaat	verzadigd	23	-	-	-	b	b	-
Benzeen	100%	23	n	b	b	n	bb	n
Benzeenzuur	verzadigd	23	-	-	-	b	bb	-
Benzine	100%	20	-	b	b	n	bb	b
Bier	-	20	b	-	-	b	b	-
Blauwzuur	-	20	b	-	-	-	b	-
Bleekwater (0,1 % Act. Chloor)	-	20	-	n	n	bb	bb	-
Boenwas	-	20	bb	-	-	-	-	bb
Boorzuur	10%	20	-	b	b	b	b	b
Borax	verzadigd	23	-	-	-	b	-	n
Boter	-	20	n	bb	bb	b	b	-
Brandwijn	-	-	-	b	b	b	b	-
Broom (vloeibaar)	100%	20	n	-	-	-	n	n
Broomzuur	50%	23	-	-	-	b	bb	n
Butaan (vloeibaar)	100%	20	n	b	b	n	b	n
Calciumcarbonaat	verzadigd	23	-	bb	bb	b	b	-
Calciumchloride	verzadigd	23	-	-	n	n	b	b
Calciumhydroxide	verzadigd	23	-	-	-	b	b	-
Calciumnitraat	verzadigd	23	-	-	-	b	b	b
Calciumsulfaat	verzadigd	23	-	-	-	b	b	-
Chloorgas	100%	20	-	n	bb	n	n	n
Chloorwater	-	20	-	n	n	n	bb	n
Chloroform	100%	20	-	n	n	n	bb	n
Chroomzuur	1%	20	-	bb	n	b	b	-
Chroomzwavelzuur	-	20	n	-	-	bb	n	n
Citroensap	-	20	b	-	-	b	b	b
Citroenzuur	10%	20	-	b	b	b	b	b
Citroenzuur	verzadigd	23	b	-	-	b	b	-
Cyaankali	waterig	20	b	b	b	-	b	-
Dextrose	verzadigd	23	-	-	-	b	b	-
Dieselolie	100%	20	bb	b	b	n	b	n
Eiwitoplossing	-	20	b	-	-	-	-	-
Ethanol	96%	20	-	b	b	b	b	bb
Ethanol	10%	20	b	-	-	-	b	b
Ether	-	20	n	-	-	-	n	-
Etherische olie	-	20	bb	-	-	-	-	-

Bestendigheidstabel

Medium	Concentratie %	°C	PVC	PA	PU	PE	PPC	Vinnylan
Ethylacetaat	100%	20	n	-	-	-	b	n
Fixeer	100%	20	b	-	-	-	b	b
Fluorwaterstof	40%	20	-	n	n	n	b	-
Foazelolie	-	20	bb	-	-	-	-	-
Formaldehyde	40%	23	-	-	-	b	b	bb
Fosforzuur	10%	20	b	b	bb	b	b	b
Freon 12dichloor	-	-	-	-	-	-	-	-
difluormethaan	-	20	-	b	bb	n	n	-
Fructose	verzadigd	23	-	-	-	b	b	-
Gasoline	100%	20	n	-	-	-	bb	n
Gedestilleerd water	-	20	b	-	-	-	b	-
Gelatine	-	20	b	-	-	-	b	-
Gesmolten was	-	-	-	b	b	b	bb	-
Glühwijn	-	20	b	-	-	b	b	b
Glycerine	100%	23	bb	b	b	b	b	b-bb
Glycerol	100%	20	bb	-	-	-	b	b-bb
Glycol	100%	20	bb	-	-	-	b	b-bb
Glycolzuur	30%	23	-	-	-	b	b	-
Haarshampoo	-	20	b	-	-	-	b	b
Hexaan	100%	20	n	b	-	b	b	n
Ijzerchloride	10%	20	-	b	b	b	b	-
Ijzerdichloride	verzadigd	23	-	-	-	b	-	-
Ijzernitraat	verzadigd	23	-	-	-	b	b	-
Ijzerzout	verzadigd	20	b	-	-	-	b	b
Inkt	-	20	b	-	-	-	-	b
Jodiumtinctuur	-	20	-	n	n	b	b	-
Kaliloog	10%	20	b	b	b	b	b	b
Kaliumbromide	verzadigd	23	-	-	-	b	b	-
Kaliumcarbonaat	geconcentreerd	23	-	-	-	b	b	n
Kaliumcarbonaat (in water)	verzadigd	20	b	-	-	-	b	b
Kaliumchloride	verzadigd	23	-	-	-	b	b	-
Kaliumchloride (in water)	verzadigd	20	b	-	-	-	b	b
Kaliumhydroxide	20%	23	-	-	-	b	b	-
Kaliumjodide	verzadigd	20	b	-	-	-	b	b
Kaliumnitraat	verzadigd	23	-	-	-	b	b	-
Kaliumnitraat	10%	20	-	bb	b	b	b	-
Kaliumsulfaat	geconcentreerd	23	-	-	-	b	b	-
Kaliumsulfaat (in water)	verzadigd	20	b	-	-	-	b	-
Kaliumsulfiet	geconcentreerd	23	-	-	-	b	b	-
Kaliumwaterglas	-	20	b	-	-	-	-	b
Kalzeep	-	20	b	-	-	-	b	-
Keukenzout	-	20	b	-	-	-	b	b
Kiezelzuur	verzadigd	23	-	-	-	b	b	-
Kooldioxide	-	20	b	-	-	-	b	-
Koperchloride	verzadigd	23	-	n	n	b	b	-
Kopernitraat	verzadigd	23	-	-	-	b	b	-
Kopersulfaat	10%	20	-	b	-	b	b	-
Koud water	-	-	-	b	b	b	b	b
Kunstzijde	-	20	b	-	-	-	b	-
Lanoline	-	20	bb	-	-	-	b	bb
Latex	100%	23	-	-	-	b	b	-
Lijnolie	-	20	bb	b	b	n	b	-
Limonade	-	20	b	-	-	b	b	b
Loodacetaat	verzadigd	23	-	-	-	b	b	-
Loodzout	-	20	b	-	-	-	-	-
Looistof	-	20	b	-	-	-	b	-
Magnesiumcarbonaat	verzadigd	23	-	-	-	b	b	-
Magnesiumchloride	verzadigd	23	-	-	-	b	b	-
Magnesiumhydroxide	verzadigd	23	-	-	-	b	b	-
Magnesiumnitraat	verzadigd	23	-	-	-	b	b	-
Magnesiumsulfaat	verzadigd	23	-	-	-	b	b	-
Magnesiumzout	verzadigd	20	b	-	-	-	b	b
Mayonaise	-	20	bb	-	-	b	-	b-bb
Melkzuur	10%	20	-	n	n	b	b	b
Meststofzout	100%	20	n	-	-	b	-	-
Methanol	-	20	-	b	b	b	b	n
Methylacetaat	100%	20	-	b	b	-	b	n
Methylalcohol	100%	20	n	-	-	-	b	n
Methylalcohol (in water)	50%	20	bb	-	-	-	b	n

Bestendigheidstabel

Medium	Concentratie %	°C	PVC	PA	PU	PE	PPC	Vinnylan
Methylbenzeen	100%	20	n	-	-	-	bb	n
Methyleenchloride	100%	23	n	n	bb	b	bb	n
Mierenzuur	98%	20	n	n	n	n	b	n
Mierenzuur	10%	20	b	n	n	b	b	b
Mineraalolie	100%	23	-	b	b	bb	b	n
Mineraalolie (aromatenvrij)	-	20	bb	-	-	-	b	bb
Nagellak	-	20	n	b	-	-	-	n
Nagellakremover	-	20	n	-	-	-	-	n
Natriumcarbonaat	verzadigd	23	-	-	-	b	b	n
Natriumcarbonaat	10%	20	-	b	b	b	b	b
Natriumcarbonaat (in water)	verzadigd	20	b	b	b	-	b	bb
Natriumchloride	10%	20	-	bb	bb	b	b	b
Natriumfosfaat (in water)	verzadigd	20	b	-	-	-	b	b
Natriumhydroxide	10%	20	b	-	-	-	b	-
Natriumnitraat (in water)	verzadigd	20	b	-	-	-	b	bb
Natriumsulfaat	10%	20	-	n	n	b	b	b
Natriumsulfide (in water)	verzadigd	20	b	-	-	b	b	b
Natronloog	10%	20	bb	b	b	b	b	b
n-butylalcohol	100%	20	n	-	-	-	-	n
Nicotinezuur	100%	23	-	-	-	b	b	-
Nikkelchloride	verzadigd	23	-	-	-	b	b	b
Nikkelnitraat	geconcentreerd	23	-	-	-	b	b	-
Nikkelsulfaat	verzadigd	23	-	-	-	b	b	-
Nitrobenzeen	100%	20	n	-	-	-	b/bb	n
Nitroglycerine	-	20	bb	-	-	-	b	-
Octaan	100%	20	n	-	-	-	b	-
Oxaalzuur	10%	20	-	n	-	b	b	b
Ozon	-	20	-	n	n	bb	bb	b
Paraffine	100%	20	bb	-	-	-	b	bb
Paraffineolie	100%	20	bb	-	-	-	b	bb
Parfum	-	20	n	b	b	n	b	n
Pectine	verzadigd	20	b	-	-	-	b	b
Perchloorethyleen	100%	20	n	-	-	-	n	n
Petroleum	100%	20	n	b	b	bb	b	n
Propaan (vloeibaar)	100%	20	n	b	b	n	b	n
Propyleenglycol	100%	23	-	-	-	b	-	-
Pyridine	100%	20	n	b	b	b	bb	n
Salicylzuur	-	20	b	-	-	-	b	-
Salpeterzuur	10%	20	bb	n	n	bb	n	b-bb
Schoensmeer	-	20	bb	-	-	-	-	b
Schrijfmachineolie	-	20	bb	b	b	n	-	-
Siliciumfluorwaterstof	31.10%	23	-	-	-	b	-	-
Sojaolie	-	20	bb	-	-	b	b	bb
Stearinezuur	100%	20	b	-	-	b	b	b
Stikstof	-	20	b	-	-	-	b	-
Suikeroplossing	elke	20	b	-	-	b	b	b
Suikersap	-	20	b	-	-	b	b	-
Talg	-	20	-	b	b	b	b	-
Tandenpasta	-	20	b	-	-	-	-	b
Teer / teerolie	-	20	bb	-	-	-	b	n
Terpentine-olie	-	20	n	-	-	-	n	n
Testbenzine	-	20	n	b	bb	n	bb	n
Tomatensap	-	20	b	-	-	b	-	b
Urine	-	20	b	b	b	-	-	-
Vaseline	-	20	bb	b	b	n	b	bb
Vet/olie (dierlijk en plantaardig)	-	20	bb	b	b	n	b	-
Vetalcohol	-	20	bb	-	-	-	b	-
Vetzuur	-	20	bb	n	n	b	b	-
Wasmiddel	hoch	20	b	-	-	b	b	b
Water	-	20	b	b	b	b	b	b
Waterstof	-	20	b	-	-	-	b	-
Waterstofperoxide	0.50%	20	-	b	b	b	b	b
Waterstofsulfide	gering	20	b	-	-	-	-	-
Wijn	-	20	-	b	b	b	b	b
Wijnzuur (in water)	verzadigd	20	b	-	-	-	b	b
Xyleen	100%	20	n	b	b	n	n	n
Zeeep (vast)	-	20	b	-	-	-	-	-
Zeeewater	-	20	b	b	b	b	b	b
Zilverzout (in water)	verzadigd	20	b	-	-	-	b	b

Bestendigheidstabel

Medium	Concentratie %	°C	PVC	PA	PU	PE	PPC	Vinnylan
Zink-2-chloride	verzadigd	20	b	-	-	b	b	b
Zinkchloride	10.00%	20	-	n	n	b	b	-
Zinksulfaat	verzadigd	23	-	-	-	b	b	-
Zinkzout	-	20	b	-	-	-	b	-
Zinkzout (in water)	verzadigd	20	b	-	-	-	b	-
Zout water	elke	20	b	b	b	b	b	b
Zoutzuur	2%	20	-	n	n	b	b	b
Zuurstof	-	20	b	-	-	-	b	-
Zwavel	100%	20	b	-	-	-	b	b
Zwaveldioxide	gering	20	b	bb	bb	b	b	b
Zwavelkoolstof	-	20	n	bb	b	bb	n	n
Zwavelzuur	2%	20	-	n	n	b	b	b
Zwavelzuur	96%	20	-	-	-	-	bb	n

Verhouding werkdruk & temperatuur

De opgegeven werkdruk is gemeten bij 20 °C.

Bij verhoging van de temperatuur daalt de werkdruk met onderstaande factor.

Temperatuur	20 °C	30 °C	40 °C	50 °C	60 °C	70 °C	80 °C	90 °C	100 °C
Factor	1.00	0.95	0.82	0.74	0.62	0.51	0.44	0.40	0.30

Vermenigvuldig de opgegeven werkdruk met deze factor om de werkdruk bij gewenste temperatuur te berekenen.

Voorbeeld:

Polyamide Nylon 12 slang in maat 6x4 heeft bij 20 °C een opgegeven werkdruk van 27 bar.

Werkdruk bij 40 °C: $27 \times 0.82 = 22.1$ bar

Werkdruk bij 70 °C: $27 \times 0.51 = 13.7$ bar

Werkdruk bij 100 °C: $27 \times 0.30 = 8.1$ bar

De verhoudingen zoals genoemd in de tabel gelden voor alle slangen zonder wapening:

- Polyamide (PA)
- Polyethyleen (PE)
- Polyurethaan (PU)
- Polypropyleen (PPC)

Omreken tabel inch naar millimeter

6	152,4
5	127,0
4	101,6
3	76,2
2,1/2	63,5
2	50,8
1,1/2	38,1
1,1/4	31,8
1	25,4
3/4	19,1
1/2	12,7
3/8	8,3
1/4	6,4
1/8	3,2



MENS, MAATWERK & TECHNIEK

Professionals in Flow & Fluid Technology

Gewoon

www.aimfluid.nl



Neutrale medium



Agressieve medium



Heet water

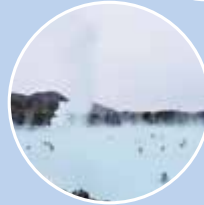

Stoom



Pneumatiek

| AIM FLUID CONTROL |

Het meten en regelen van Flow & Fluid Technology is onze 2^e natuur



aim *fluid control* sinds 1995. Als onafhankelijke specialist in het meten en regelen van diverse soorten vloeistof- en gasstromen (Flow & Fluid Technology) richt aim zich op de professionele markt. De markt met de behoefte aan standaardproducten tot aan engineeringprojecten die verregaande technische kennis vereisen op het gebied van afsluiters, magneetventielen, pneumatiek ventielen, actuators, appendages, vacuümpompen, compressoren, fittingen en toebehoren.

Vanuit het hoofdkantoor en magazijn te Son & Breugel, nabij Science Park Ekkersrijt, ontzorgt aim zijn klanten van A tot Z en biedt technische en logistieke maatwerkoplossingen middels gedegen kennis, een gedreven en persoonlijke service én een klantspecifiek voorraadbeheer.

Ontzorgend, **Betrokken** & **Verantwoordelijk**

aim fluid control b.v.
Ekkersrijt 7310-7312
5692 HH Son en Breugel / Nederland
T. +31(0) 499 49 10 90
E. info@aimfluid.nl
F. +31(0) 499 49 63 70
I. www.aimfluid.nl

