



Mens, Maatwerk & Techniek
Professionals in Flow & Fluid Technology

Bestel eenvoudig uw persluchtproducten
Zowel offline als online
30.000 producten!



Perslucht Catalogus 2017
Ook online www.aimfluid.nl



MENS, MAATWERK & TECHNIEK





































Professionals in Flow & Fluid Technology

Gewoon

www.aimfluid.nl

| ALS JE DOOR DE BOMEN HET BOS NIET MEER ZIET |

aim biedt uitkomst

 	Pagina 516	Pneumatisch gereedschap	 	Pagina 538	Smeernippels, vetspuiten & -slangen
 	Pagina 521	Verfspuiten	 	Pagina 539	Brandstofapparatuur
	Pagina 522	Veerbalancers	 	Pagina 540	Verfspuiten
	Pagina 524	JWL blaaspistolen en reinigingspistolen	 	Pagina 542	JAYMAC spuitpistolen - lagedruk
 	Pagina 529	RECTUS blaaspistolen	 	Pagina 544	Jetwash hogedrukslang
	Pagina 532	CDC, KELM & AIR-PRO blaaspistolen	 	Pagina 546	HIPRHO spuitpistolen & lansen
 	Pagina 532	Air Jet nozzles		Pagina 552	Hogedruk watersnelkoppelingen
	Pagina 534	Waspistolen		Pagina 553	Iride reinigingspistolen & lansen
	Pagina 535	Bandenpompen	 	Pagina 557	NITO spuitpistolen
 	Pagina 536	Digitale bandenpompen	 	Pagina 559	Industrieel handgereedschap
 	Pagina 537	Hogedruk snijringkoppelingen LL		Pagina 571	Metaal- & houtboren

VEILIGHEIDSTIPS:

Hieronder algemeen advies voor het gebruik van persluchtgereedschap, om schade en letsel te voorkomen op de werkplek.

(Dit is geen vervanging voor de **AEROPRO** veiligheidsvoorschriften/handleidingen).



VISUELE INSPECTIE VOOR GEBRUIK

Controleer het gereedschap, luchtslang en fittingen op tekenen van beschadiging, overmatige slijtage of defecten. Zorg ervoor dat het gereedschap is gesmeerd.

GEBRUIK DE JUISTE ACCESSOIRES

Alleen aanbevolen accessoires gebruiken met **AEROPRO** gereedschap. Gebruik bijvoorbeeld nooit handdoppen bij slagmoersleutels. Ontkoppel altijd de luchttoevoer voor het vervangen van een accessoire.

BESCHERMINGSMIDDELEN

Draag altijd noodzakelijke persoonlijke beschermingsmiddelen bij bediening van het gereedschap, zoals een veiligheidsbril en oordopjes. Draag afhankelijk van de toepassing ook handschoenen, een schort, helm & stofmasker. Zorg voor stofafzuiging bij het werken met materialen waarbij schadelijke deeltjes vrijkomen in de lucht, om blootstelling te voorkomen.

EEN VEILIGE WERKOMGEVING

Maak andere mensen bewust van uw werkgebied en zorg dat men op veilige afstand wordt gehouden. Houdt de werkomgeving schoon en verlicht en het vloeroppervlak vrij van struikelgevaar. Leidt de luchtafvoer af van uzelf en anderen. Gebruik het gereedschap niet in een explosieve atmosfeer en altijd weghouden van elektrische bedrading.

Accessoires pneumatisch gereedschap

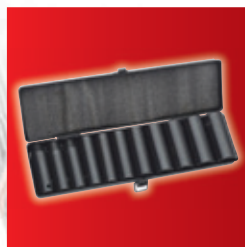

MATISCH GEREEDSCHAP

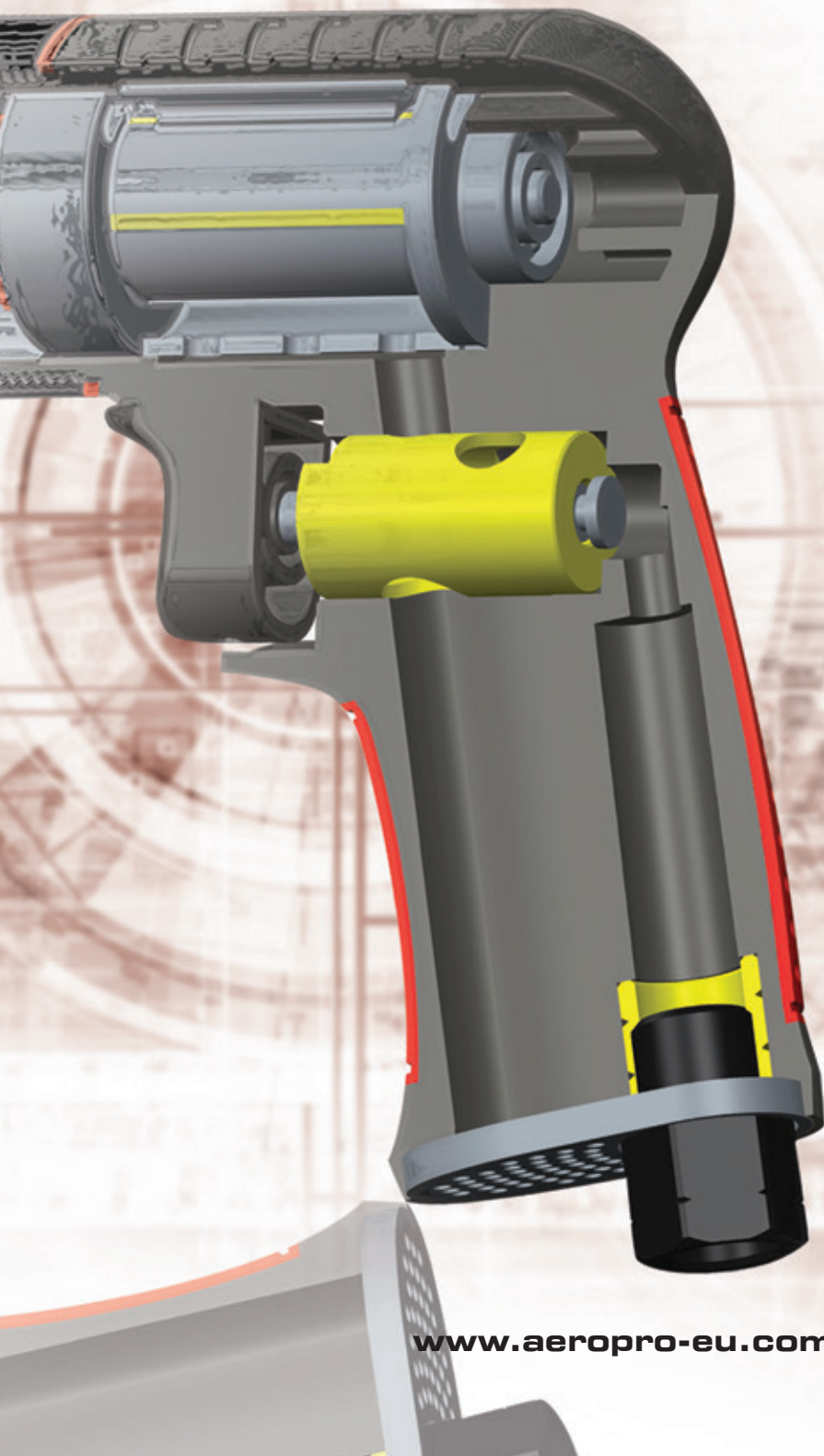

EIGENSCHAPPEN & VOORDELEN

Ontwerp:

Aantrekkelijk design,
lichtgewicht & comfortabele
composit handgreep.

Kwaliteit:

Ontworpen volgens superieure
technologie en vervaardigd met
precisie voor levering van een
groter vermogen en een langere
levensduur.

Robuust:

Volledig geharde planetaire
tandwielen verminderen wrijving
en warmtebehandelde onderdelen
zorgen voor een verhoogde
duurzaamheid.

Garantie:

12 maanden fabrieksgarantie.



www.aeropro-eu.com

Slagmoersleutel

- Het Twin hammer slagmechanisme heeft 2 identieke hamers die een evenwichtige slag leveren, dit vermindert trilling en de hoge energie die vrijkomt wordt direct doorgestuurd naar het aandrijvierkant voor maximaal vermogen.
- Afgeschermdde luchtinlaat voorkomt beschadiging van het gereedschap door vuil en puin.
- Luchtuitlaat: achterzijde
- Aanbevolen werkdruk: 6 bar



Tech Data
10235

Model No.	Square Drive	Capacity Bolt Size		Free Speed RPM	Working Torque		Overall Length		Air Inlet	Air Hose (ID)	Average Air Consumption		Net Weight	
		Imp	Met mm		Ft-Lb	N.m	In	mm			cfm	l/min	Lbs	Kgs
AP7451	1/2"	5/8"	16	7.500	450	610	7.48	190	1/4"	3/8"	6.5	183.9	4.2	1.9

1/2" slagmoersleutel - vierkantaandrijving

0373



AP7451

118.40



Tech Data
10237

Model No.	Square Drive	Capacity Bolt Size		Free Speed RPM	Working Torque		Overall Length		Air Inlet	Air Hose (ID)	Average Air Consumption		Net Weight	
		Imp	Met mm		Ft-Lb	N.m	In	mm			cfm	l/min	Lbs	Kgs
AP7460	3/4"	1"	25	7.000	1000	1355	8.2	208	3/8"	1/2"	9.5	269	6.6	3.0

3/4" slagmoersleutel - vierkantaandrijving

0373



AP7460

226.20

- Ergonomische handgreep voor comfort en stabiliteit
- Sterk slagmechanisme van gelegeerd staal voor een lange levensduur
- 45° luchtinlaat, voorkomt het roteren van de slang tijdens gebruik
- Verlengde aandrijfas voor moeilijk bereikbare plaatsen
- 4 snelheidsinstellingen (voor- en achteruit)



Tech Data
20217

Model No.	Square Drive	Capacity Bolt Size		Free Speed RPM	Working Torque		Overall Length		Air Inlet	Air Hose (ID)	Average Air Consumption		Net Weight		Suggested Air Comp
		Imp	Met mm		Ft-Lb	N.m	Imp	Met mm			cfm	l/min	Lbs	Kgs	
AP7495	1"	2"	50	2800	2500	3480	25.4	644	1/2"	5/8"	43	1225	41.6	18.9	5 HP

1" slagmoersleutel - vierkantaandrijving

0373



AP7495

635.40

Slagmoersleutelset

- Het Twin hammer slagmechanisme heeft 2 identieke hamers die een evenwichtige slag leveren, dit vermindert trilling en de hoge energie die vrijkomt wordt direct doorgestuurd naar het aandrijvierkant voor maximaal vermogen.
- Afgeschermdde luchtinlaat voorkomt beschadiging van het gereedschap door vuil en puin.
- Luchtuitlaat: achterzijde
- Aanbevolen werkdruk: 6 bar

Inhoud:

- 1x AP17407 1/2" slagmoersleutel
- 10x slagkop (9, 10, 11, 13, 14, 17, 19, 22, 24, 27mm)
- 1x 5" verlengstuk
- 1x flesje olie
- 1x inbusseleutel
- 1x mini nevelaar
- 1x insteeknippel
- 1x draagkoffer



Tech Data
10238

Model No.	Square Drive	Capacity Bolt Size		Free Speed RPM	Working Torque		Overall Length		Air Inlet	Air Hose (ID)	Average Air Consumption		Net Weight	
		Imp	Met mm		Ft-Lb	N.m	In	mm			cfm	l/min	Lbs	Kgs
AP17407	1/2"	5/8"	16	7.500	410	555	7.30	187.4	1/4"	3/8"	6.5	183.5	4.9	2.26

1/2" slagmoersleutel - vierkantaandrijving - 17-delige set

0373



AP17808

127.25

Ratelsleutel

- Ontworpen volgens superieure technologie en vervaardigd met precisie voor levering van een groter vermogen en een langere levensduur.
- Volledig geharde planetaire tandwielen verminderenrijving.
- Comfortabele handgreep.
- Eenvoudige dopwisseling.
- Warmtebehandelde onderdelen voor verhoogde duurzaamheid.
- Lichtgewicht aluminium behuizing.
- Compacte kop maakt gebruik in moeilijk bereikbare ruimtes mogelijk.
- Handige greepbediening voor het wijzigen van de draairichting.
- Luchtuitlaat: zijkant
- Aanbevolen werkdruk: 6 bar



Tech Data
10236

Model No.	Square Drive	Capacity Bolt Size		Free Speed RPM	Working Torque		Overall Length		Air Inlet	Air Hose (ID)	Average Air Consumption		Net Weight	
		Imp	Met mm		Ft-Lb	N.m	In	mm			cfm	l/min	Lbs	Kgs
AP17411	3/8"	1/2	13	160	50	68	10.8	275	1/4"	3/8"	3	85.5	2.5	1.15

3/8" ratelsleutel - vierkantaandrijving

0373



AP17411-3/8

57.20

Hakhamer

- Ergonomische handgreep voor comfort en stabiliteit.
- Warmtebehandelde impact onderdelen voor een verhoogde duurzaamheid.
- Gasgreep en ingebouwde vermogensregelaar voor eenvoudige kracht- en snelheidscontrole.
- Afgeschermdeluchtinlaat voorkomt beschadiging door vuil en puin.
- Standaard snelwisselvoor snelle en eenvoudige beetelwisseling.
- Luchtuitlaat: voorzijde
- Aanbevolen werkdruk: 6 bar

Inclusief 4-delige beetelset.



Tech Data
10242

Model No.	Chisel Shank mm	Blows per min	Air Inlet	Air Hose (ID)	Overall Length		Average Air Consumption		Net Weight	
					In	mm	cfm	l/min	Lbs	Kgs
AP17621	10.2	4,500	1/4"	3/8"	6.10	155	2.8	79.8	2.65	1.2

Heavy duty

0373



AP17621

30.85

Slagschroevendraaier

- Duurzame aluminium behuizing
- Snelspankop maakt gebruik van 1/4" hex bithouder
- Geschikt voor schroeven van maximaal 5.0mm
- Aanbevolen werkdruk: 6 bar



Tech Data
20218

Model No.	Square Drive	Capacity Bolt Size		Free Speed RPM	Working Torque		Overall Length		Air Inlet	Air Hose (ID)	Average Air Consumption		Net Weight		Suggested Air Comp
		Imp	Met mm		Ft-Lb	N.m	Imp	Met mm			cfm	l/min	Lbs	Kgs	
AP17225	1/4"	2"	13	11000	33	45	6.9	176	1/4"	1/4"	2.6	74	1.83	0.76	2 HP

1/4" slagschroevendraaier - vierkantaandrijving

0373



AP17225

49.65

Tech Data
10236



Model No.	Square Drive	Capacity Bolt Size		Free Speed RPM	Working Torque		Overall Length		Air Inlet	Air Hose (ID)	Average Air Consumption		Net Weight	
		Imp	Met mm		Ft-Lb	N.m	In	mm			cfm	l/min	Lbs	Kgs
AP17411	1/2"	1/2"	13	160	50	68	10	254	1/4"	3/8"	2.7	77	2.4	1.1

1/2" ratelsleutel - vierkantaandrijving

0373



AP17411-1/2

57.20

- **tst** (drukknop) snelkoppelingen & insteeknippels vanaf pagina 257



tst

Rechte boormachine

- Compacte en handzame boormachine.
- Precisie-bewerkte tandwielen garanderen maximale vermogensoverdracht en duurzaamheid.
- Lichtgewicht - helpt vermoeidheid bij langdurig gebruik te voorkomen.
- Ideaal voor gebruik op plaatsen waar ruimte beperkt is.
- Aanbevolen werkdruk: 6 bar



Tech Data
10239

Model No.	Chuck Size	Free Speed RPM	Air Inlet	Air Hose (ID)	Overall Length		Average Air Consumption		Net Weight	
					In	mm	cfm	l/min	Lbs	Kgs
AP17111	3/8"	2,600	1/4"	3/8"	8.8	225	4.0	115	1.87	0.85

3/8" boormachine - tandkransboorhouder

0373



AP17111

46.20

Combi tacker

- Sterk en lichtgewicht drukgegoten aluminium huis
- Multi-directionele uitlaat leidt lucht weg van de operator en werkplek
- Teflon O-ring beschermt de zuiger tegen slijtage
- Regelbare diepte-instelling
- Instelbare draaiknop voor sequentiële of contactschoten
- Ontworpen voor Ga18 type nieten en nagels tot lengte 50mm



Tech Data
20219

Model No.	Dimensions (mm)	Required Pressure		Max Pressure		Nail Capacity	Weight	
		PSI	Bar	PSI	Bar		lbs	kgs
APSF5040RC	283x256x60	70-110	4.8-7.5	120	8.3	100 Pcs	3.52	1.6

Nieten & nagels

0373



APSF5040RC

88.10

Omkeerbare boormachine

- Compacte en handzame boormachine.
- Doseerbare snelheidsregeling voor een makkelijke start.
- Precisie-bewerkte tandwielen garanderen maximale vermogensoverdracht en duurzaamheid.
- Handige drukknop voor verandering van draairichting
- Lichtgewicht - helpt vermoeidheid bij langdurig gebruik te voorkomen.
- Stille werking met achteruitlaat - leidt lucht weg van de werkplek.
- Constructie met kogellagers.
- Aanbevolen werkdruk: 6 bar



Tech Data
10240

Model No.	Chuck Size	Free Speed RPM	Air Inlet	Air Hose (ID)	Overall Length		Average Air Consumption		Net Weight	
					In	mm	cfm	l/min	Lbs	Kgs
AP17101	3/8"	1,800	1/4"	3/8"	7	180	3.7	104	1.98	0.9

3/8" boormachine - tandkransboorhouder

0373



AP17101

50.40



Tech Data
10241

Model No.	Chuck Size	Free Speed RPM	Air Inlet	Air Hose (ID)	Overall Length		Average Air Consumption		Net Weight	
					In	mm	cfm	l/min	Lbs	Kgs
AP17107	1/2"	700	1/4"	3/8"	7.68	195	4	115	1.18	1.19

1/2" boormachine - tandkransboorhouder

0373



AP17107

58.35

Stiftslijper

- Lichtgewicht aluminium behuizing.
- Veiligheidsgreep voorkomt onopzettelijke start.
- Luchtuitlaat: achterzijde
- Toepassing: afwerking van lasnaden, polijsten, slijpen, frezen en afbramen.
- Aanbevolen werkdruk: 6 bar



Tech Data
10243

Model No.	Grinder Cap	Free Speed RPM	Air Inlet	Air Hose (ID)	Average Air Consumption		Net Weight	
					cfm	l/min	Lbs	Kgs
AP17313	1/4"	20,000	1/4"	3/8"	3	86.25	0.70	0.32

1/4" stiftslijper - recht

0373



AP17313

24.90

- Haakse slijpkop biedt toegang tot moeilijk bereikbare ruimtes.
- Lichtgewicht aluminium behuizing.
- Luchtuitlaat: achterzijde
- Toepassing: afwerking van lasnaden, polijsten, slijpen, frezen en afbramen.
- Aanbevolen werkdruk: 6 bar



Tech Data
10244

Model No.	Grinder Cap	Free Speed RPM	Air Inlet	Air Hose (ID)	Average Air Consumption		Net Weight	
					cfm	l/min	Lbs	Kgs
AP17315	1/4"	20,000	1/4"	3/8"	2.2	62	0.99	0.45

1/4" stiftslijper - haaks

0373



AP17315

45.85

Stiftslijperset

- Haakse slijpkop biedt toegang tot moeilijk bereikbare ruimtes
- Lichtgewicht aluminium behuizing
- Veiligheidsgreep voorkomt onopzettelijke start
- Luchtuitlaat: achterzijde
- Toepassing: afwerking van lasnaden, polijsten, slijpen, frezen en afbramen
- Aanbevolen werkdruk: 6 bar

Inhoud:

- 1x AP17315 1/4" stiftslijper - haaks
- 2x handsleutels
- 10x slijpstenen
- 1x insteeknippel
- 1x kraag
- 1x draagkoffer



Tech Data
20220

Model No.	Grinder Cap	Free Speed RPM	Air Inlet	Air Hose (ID)	Average Air Consumption		Net Weight	
					cfm	l/min	Lbs	Kgs
AP17315	1/4"	20,000	1/4"	3/8"	2.2	62	0.99	0.45

1/4" stiftslijper - haaks - 16-delige set

0373



AP17803-A

56.40

Haakse slijper

- Ingebouwde regelaar voor snelheidscontrole.
- Planetair tandwielmechanisme.
- Luchtuitlaat: zijkant
- Aanbevolen werkdruk: 6 bar



Tech Data
10245

Model No.	Sanding Pad		Free Speed RPM	Air Inlet	Air Hose (ID)	Average Air Consumption		Net Weight	
	In	mm				cfm	l/min	Lbs	Kgs
AP7319	4"	100	10,000	1/4"	3/8"	5	140	2.86	1.3
	5"								

4" haakse slijper - heavy duty

0373



AP7319

53.80

- Voor drukknop veiligheidssnelkoppelingen conform ARB0/ISO 4414 zie pagina 257 en 262
- Met Euro, Orion & ISO 6150-C profiel



tst®

Multifunctionele gereedschapset

- Multitool voor zagen, schrapen, slijpen en schuren
- Veelzijdige multi-positie bladmontage
- Ergonomisch ontwerp
- Lichtgewicht - helpt vermoeidheid bij langdurig gebruik te voorkomen
- Doseerbare snelheidsregeling voor een makkelijke start

Inhoud:
Multitool
3.1/2" zaagblad half rond
2.1/2" slijpschijf diamant half rond
2" vlakke schraper + schraper
1-1/2", 3/4" en 3/8" vlakke snijbladen
3" driehoekig schuurplateau
Schuurpapierset K60/80/100/120 (12 stuks)



Tech Data
20221

Model No.	Max Swing Angle	Swing Frequency	Air Inlet	Air Hose (ID)	Overall Length		Average Air Consumption		Net Weight	
					Imp	Met mm	cfm	l/min	Lbs	Kgs
AP7636	2.8"	16000	1/4"	3/8"	8.5	217	4.5	128	1.87	0.853

Slijp- en polijstset - haaks - 21-delige set

0373

AP7636



75.50

Snelspanboorkop

3/8" & 1/2"

0373

APKLC38
APKLC12

To
Suit

3/8"
1/2"



10.95
11.70

Beitelset

Inhoud:
Platte beitel
Puntbeitel
Voegbeitel
Tandbeitel



Geschikt voor AP17621 - 4-delige set

0373

AP7002-7



4.80

Veer voor hakhamer

Geschikt voor AP17621

0373

AP7001



2.30

1/2" slagdopset

Inhoud:
Zeskantmaten 11, 12, 13, 14, 16, 17, 19, 21, 22 en 24mm

Gehard staal - zeer robuust en voor intensief gebruik.
Wordt geleverd in kunststof cassette.



Metrisch - 10-delige set

0373

AP7006



22.00

Inhoud:
Zeskantmaten 3/8", 7/16", 1/2", 9/16", 5/8", 11/16", 3/4", 13/16", 7/8", 15/16" & 1"

Gehard staal - zeer robuust en voor intensief gebruik.
Wordt geleverd in stalen cassette.



Imperial - 11-delige set

0373

AP7007



39.20

Pneumatische basisset

Inhoud:
• Verfspuitpistool
• Blaaspistool
• Bandenpomp
• Spuitpistool
• 5 meter PE spiraalslang met Euro snelkoppeling



5-delige set

0373

AP8031K5G



49.65

HVLP

Hoog volume, lage druk (High Volume, Low Pressure) verfspuiten hebben een vergelijkbaar ontwerp als conventionele verfspuiten. In tegenstelling tot verfspuiten die onder hoge druk werken, werkt een HVLP verfspuit op een veel lagere druk.

- Een effectieve overdracht van het materiaal, met minder kans op spuitnevel
- Een consistente en gladde afwerking van de laklaag
- Minder milieubelasting in vergelijking met conventionele verfspuiten
- Verbruikt minder materiaal door het minimaliseren van spuitnevel

Verfspuiten

- Gesmeed aluminium huis
- RVS naald en nozzle voor gebruik met verschillende coatings
- Inclusief verstelbare vloeistof-, patroon- en luchtregeeling

LVL

Laag volume, lage druk (Low Volume, Low Pressure) verfspuiten verbruiken minder lucht dan de HVLP verfspuiten en worden vooral gebruikt voor complexere kleine gebieden. Toegepast bij het spuiten van auto's en behandeling van meubels e.d.

- Gebruikt een lage hoeveelheid lucht om een fijne verfnevel te creëren voor een zeer egale afwerking
- Minimalisering van spuitnevel en minder verspilling van materiaal

- Ontworpen om gelijke verdeling en deeltjesgrootte te leveren voor allerlei verfsoorten
- Lichtgewicht, ergonomisch ontwerp voor extra gebruikerscomfort



Tech Data
20575

Model No.	Type of Feed	Paint Capacity (cc)	Operating Pressure (Bar)	Patern Width (mm)	Air Consumption (cfm)	Standard Nozzle (mm)
APH827A	Gravity	600	2.0-3.5	180-250	4.2-7.1	1.4

HVLP - 600cc kunststof bovenbeker

0373 €
APH827A 49.65



Tech Data
20577

Model No.	Type of Feed	Paint Capacity (cc)	Operating Pressure (Bar)	Patern Width (mm)	Air Consumption (cfm)	Standard Nozzle (mm)
APR500	Gravity	600	2.0-3.5	180-250	3.0-3.9	1.5

LVL - 600cc kunststof bovenbeker

0373 €
APR500 66.70

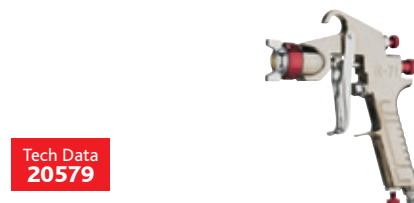

Tech Data
20579

Model No.	Type of Feed	Paint Capacity (cc)	Operating Pressure (Bar)	Patern Width (mm)	Air Consumption (cfm)	Standard Nozzle (mm)
APR71	Pressure	-	3.0-4.0	180-250	3.5-6.4	1.5

Druktoevoer - inclusief 400cc metalen bovenbeker

0373 €
APR71 59.15



Tech Data
20576

Model No.	Type of Feed	Paint Capacity (cc)	Operating Pressure (Bar)	Patern Width (mm)	Air Consumption (cfm)	Standard Nozzle (mm)
APAS1005	Suction	1000	2.0-3.5	180-250	4.2-7.1	1.4

HVLP - 1000cc aluminium onderbeker

0373 €
APAS1005 54.85



Tech Data
20578

Model No.	Type of Feed	Paint Capacity (cc)	Operating Pressure (Bar)	Patern Width (mm)	Air Consumption (cfm)	Standard Nozzle (mm)
APR200S	Suction	1000	2.0-3.5	180-250	3.0-3.9	1.5

LVL - 1000cc aluminium onderbeker

0373 €
APR200S 69.50



Tech Data
20580

Model No.	Type of Feed	Paint Capacity (cc)	Operating Pressure (Bar)	Patern Width (mm)	Air Consumption (cfm)	Standard Nozzle (mm)
AP100B	Suction	600	3.0-4.0	180-250	4.2-6.4	1.5

Detailwerk - 600cc aluminium onderbeker

0373 €
AP100B 26.55

Nozzle maat (mm)	Applicatie
1.3	Clearcoats
1.4 to 1.7	Basecoats
1.8 to 2.2	Primers



Nozzleset

0373	Passend op	mm	€
APH827-N1.4	APH827A	1.4	15.15
APH827-N1.7	APH827A	1.7	15.15
APH827-N2.2	APH827A	2.2	15.15
APAS1005-N1.4	APAS1005	1.4	15.15
APAS1005-N1.7	APAS1005	1.7	15.15
APAS1005-N2.2	APAS1005	2.2	15.15
APR500R200S-N1.3	APR500 & APR200S	1.3	15.15
APR500R200S-N1.5	APR500 & APR200S	1.5	15.15
APR500R200S-N2.0	APR500 & APR200S	2.0	15.15
APR71-N1.3	APR71	1.3	15.15
APR71-N1.5	APR71	1.5	15.15
APR71-N1.7	APR71	1.7	15.15
AP100B-N1.5	AP100B	1.5	12.70

Popnageltang

Werkdruk:
6 bar (90 psi)
Afmeting:
271 x 255 mm
Gewicht:
1,75 kg
Luchtinlaat:
1/4" BSP female
Luchtverbruik:
4.2 cfm
Geluidsdruk:
73 dB(A)
Geluidsniveau:
65 dB(A)
Vibratieniveau:
0,7 m/s²



2017-0460

116.15

Inhoud:
20 stuks 1/8" x 7/32"
30 stuks 5/32" x 7/32"
30 stuks 1/8" x 5/16"
20 stuks 3/16" x 5/16"



2021-0233

3.50



Veerbalancer

Tech Data
20433



Instelbaar



2021-0209	0,6 - 1,5	1,6	30.00
2021-0217	1 - 2	1,6	30.00
2021-0225	1,5 - 3	1,5	47.15
2021-2030	3 - 5	1,5	63.30

Redashe



- Verstelbare maximale lengte
- Nauwkeurig verstelbare veer
- Incl. veiligheidsmechanisme



Huis:
Gegoten aluminium
Kabel:
Roestvast staal

Heavy duty - instelbaar



M9311	0,4 - 1	1,6	87.60
M9312	1 - 2	1,6	124.75
M9313	2 - 3	1,6	142.60
M9320	1 - 2,5	2	216.25
M9321	2 - 4	2	237.25
M9322	4 - 6	2	273.95
M9323	6 - 8	2	313.55
M9331	2 - 4	2,5	264.65
M9332	4 - 6	2,5	374.95
M9333	6 - 8	2,5	438.30
M9334	8 - 10	2,5	474.10
M9335	10 - 14	2,5	570.30

MultiFlex swivelkoppeling - aluminium

De MultiFlex swivelkoppeling is een ingenieuze multi-directionele koppeling die ervoor zorgt dat de slang in de ideale stand blijft, ongeacht de positie van de gebruiker en het gereedschap.

Het MultiFlex mechanisme buigt en draait 360° in alle richtingen, waardoor de slang niet knikt en recht blijft. Hierdoor is werken in een kleine ruimte mogelijk. De slang voelt bijna gewichtloos door toepassing van deze koppeling.

Kenmerken & voordelen

- Verbeterde ergonomie; minder kracht nodig voor beweging van het gereedschap en slang
- Minder slangslijtage
- Hoge doorstroomcapaciteit en een lage drukval
- Sterk en duurzaam voor een lange levensduur

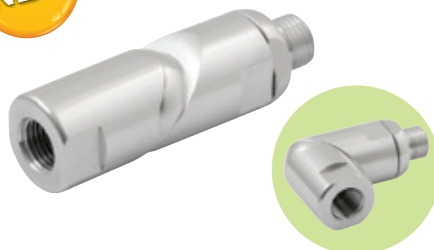

Werktemperatuur:
-10°C tot +70°C

Werkdruk:
10 bar

Tech Data
20443

BSP male/female



MFCB-02	1/8"	60.55
MFCB-04	1/4"	60.55
MFCB-06	3/8"	80.00
MFCB-08	1/2"	80.00

NPT male/female



MFCN-02	1/8"	100.55
MFCN-04	1/4"	78.80
MFCN-06	3/8"	101.45
MFCN-08	1/2"	101.45



Air Boy[®] Blowguns for multiple use

- | | | |
|---|---|--|
| <p>1 Air Boy[®] Classic
Robust and impact resistant, infinitely adjustable, leak free</p> <p>2 Silent Air Boy[®]
Low noise level and unblockable</p> <p>3 SUPER Silent Air Boy[®]
Low noise level, unblockable and high blowing force</p> <p>4 Safety Air Boy[®]
Safety blowgun with automatic pressure reduction to 2 or 3,5 bar</p> <p>5 Air Boy[®] Anti-Block
Unblockable Safety Blowgun</p> | <p>6 Air Boy[®] Non Scratch
It prevents scratching and damage</p> <p>7 Air Boy[®] Stainless
Ideal for fluids and aggressive environments</p> <p>8 Air Boy[®] TURBO
The venturi nozzle increases air flow by 100%</p> <p>9 Air Boy[®] 90° Angle Nozzle
Ideal for cleaning hard to reach places</p> | <p>10 Jet Air Boy[®]
High blowing force, unblockable and low noise level</p> <p>11 Air Boy[®] Bicycle
Inflating guns for bicycles with Dunlop & Presta valves</p> <p>12 Air Boy[®] Ball
Inflating guns for footballs etc.</p> <p>13 Air Boy[®] Car
Inflating guns for cars, bicycles & etc. with Schrader valves</p> |
|---|---|--|



The JWL Air Boy blowguns have been thoroughly tested over the years – and the valve system is guaranteed leak-free even after 28 million operations.

Therefore, we are also proud to offer you a 25 year warranty on the valve system in your Air Boy[®] blowgun!

Made in Denmark

Blaaspistolen

Industriële topkwaliteit, robuust en slagvast, gegarandeerd lekvrij.

Toepassingen: bouw, garages, industrie, informatie technologie, laboratoria, elektronica algemeen, voedingsindustrie.

Materiaal: huis, greep en klep: acetaal kunststof
 veer: gehard staal
 blaaspijp: verzinkt staal
 dichting en O-ring: NBR



25 garantie op het afsluitsysteem



Temperatuur:
-10°C tot +80°C



Maximale druk: 16 bar
Geadviseerde maximale werkdruk: 8 bar



Gemeten bij 8 bar



Draag altijd een veiligheidsbril.

Air Boy® Classic blaaspistool

Tech Data
60024



Standaard - gebogen blaaspijp - BSP female

BLAA	Nozzle	BSPP	FLOW	€
14010213	6mm gebogen	1/4"	330	16.00
14010113	8mm gebogen	1/4"	380	14.35
14012013	8mm gebogen RVS	1/4"	380	33.05

Tech Data
60025



Regelbaar - gebogen blaaspijp - BSP female

BLAA	Nozzle	BSPP	FLOW	€
14010413	6mm gebogen	1/4"	330	27.55
14010313	8mm gebogen	1/4"	380	28.30

Tech Data
60026



Verlengd - gebogen lange blaaspijp - BSP female

BLAA	Nozzle	BSPP	FLOW	€
140112B-000	8mm gebogen - 300mm	1/4"	380	28.80
140113B-000	8mm gebogen - 500mm	1/4"	380	31.65
140114B-000	8mm gebogen - 1000mm	1/4"	380	37.35

Tech Data
60026



Verlengd - rechte lange blaaspijp - BSP female

BLAA	Nozzle	BSPP	FLOW	€
14011213	8mm recht - 300mm	1/4"	380	27.45
14011313	8mm recht - 500mm	1/4"	380	30.15
14011413	8mm recht - 1000mm	1/4"	380	35.60

Tech Data
60027



FOOD RVS POM - gebogen blaaspijp - BSP female

BLAA	Nozzle	BSPP	FLOW	€
140120-159	8mm gebogen	1/4"	380	33.90

Tech Data
60024



Standaard - zonder blaaspijp - BSP female

BLAA	Nozzle	BSPP	FLOW	€
140858-000	1/4" schroefdraad	1/4"	380	13.45

Air Boy® Turbo blaaspistool

Tech Data
60028



Met Venturi nozzle - gebogen blaaspijp - BSP female

BLAA	Nozzle	BSPP	FLOW	€
14011013	6mm gebogen	1/4"	300	35.15
14011113	8mm gebogen	1/4"	300	35.15

Air Boy® Anti-Block blaaspistool

Tech Data
60029



Met ontluchting - gebogen blaaspijp - BSP female

BLAA	Nozzle	BSPP	FLOW	€
140106-000	6mm gebogen	1/4"	330	23.95

Blaaspistolen

Air Boy® Silent blaaspistool

Tech Data
60031



Geluidgedempt - gebogen blaaspijp - BSP female

BLAA	Nozzle	BSPP	FLOW	€
14012513	8mm gebogen	1/4"	260	29.10

Tech Data
60031



Geluidgedempt - rechte blaaspijp - BSP female

BLAA	Nozzle	BSPP	FLOW	€
14012613	8mm recht	1/4"	260	31.40

Tech Data
60032



Geluidgedempt en regelbaar - gebogen blaaspijp - BSP female

BLAA	Nozzle	BSPP	FLOW	€
14013513	8mm gebogen	1/4"	260	40.35

Tech Data
60032



Geluidgedempt en regelbaar - rechte blaaspijp - BSP female

BLAA	Nozzle	BSPP	FLOW	€
14013613	8mm recht	1/4"	260	42.50

Air Boy® Super Silent blaaspistool

Tech Data
60033



Maximale druk: 12 bar
Geadviseerde maximale werkdruk: 8 bar



Temperatuur:
-10°C tot +60°C



Geluidgedempt en hoge blaaskracht - gebogen blaaspijp - BSP female

BLAA	Nozzle	BSPP	FLOW	€
140141-000	8mm gebogen RVS	1/4"	330	32.45

Tech Data
60033



Geluidgedempt en hoge blaaskracht - rechte blaaspijp - BSP female

BLAA	Nozzle	BSPP	FLOW	€
140140-000	8mm recht RVS	1/4"	330	32.45

Air Boy® Safety blaaspistool

Tech Data
60030



Automatische drukverlaging - gebogen blaaspijp - BSP female

BLAA	Nozzle	BSPP	FLOW	bar	€
140161-000	8mm gebogen	1/4"	140	2	75.70
140171-000	8mm gebogen	1/4"	220	3.5	75.70

Tech Data
60030



Automatische drukverlaging - rechte blaaspijp - BSP female

BLAA	Nozzle	BSPP	FLOW	bar	€
14016013	8mm recht	1/4"	140	2	74.80
14017013	8mm recht	1/4"	220	3.5	74.80

KELM™
pneumatiek

Hydrauliek

Snel-
koppelingen

Atsluiters

Roestvast
staal

Fittingen

Lucht-
conditioning

Gereedschap

Pneumatiek

Diversen

Malleabele
fittingen
& staal

Ringleiding-
systemen

Slangen

Compressoren

Blaaspistolen

Air Boy® pomp pistool

Tech Data
60034



Met pompnaald voor o.a. voetbal - BSP female

BLAA				
14010813	Pomppistool	1/4"	200	34.50
14010814	Losse blaasnaald	-	-	10.80

Air Boy® bandenpomppistool

Tech Data
60035



Voor fietsen (Dunlop/Presta ventiel) - gebogen blaaspijp - BSP female

BLAA				
14011813	8mm gebogen	1/4"	380	39.25

Tech Data
60533



Voor auto's (Schrader ventiel) - gebogen blaaspijp - BSP female

BLAA				
140119-000	8mm gebogen	1/4"	380	41.25

Bandenpompnippel



Voor auto of fiets

BLAA			
15011000	Euro profiel voor auto	300	22.05
15011100	Euro profiel voor fiets	300	22.05
15011200	Pilaar 7.9mm voor auto	300	21.55
15011300	Pilaar 7.9mm voor fiets	300	21.55

Jet Air Boy® nozzle

Nozzles voor gebruik met o.a. blaaspistool
140858-000 (zonder blaaspijp)

Tech Data
60036



POM - luchtzuinig

BLAA				
14100013	1/4"	0-580	32mm	17.50

Tech Data
60036



ULTEM1000 200°C - geluidsarm

BLAA				
14100113	1/4"	0-580	32mm	22.65

Air Boy® nozzle

Tech Data
60037



Venturi nozzle

BLAA		
14011606	Bypass voor 6mm blaaspijp	9.45
14011508	Bypass voor 8mm blaaspijp	8.90

Tech Data
60038

Zodra gemonteerd kan onderstaande reinigingsnozzle niet meer gedemonteerd worden



90° reinigingsnozzle

BLAA		
144177	Nozzle voor 8mm blaaspijp	24.55

Sodablastster 2

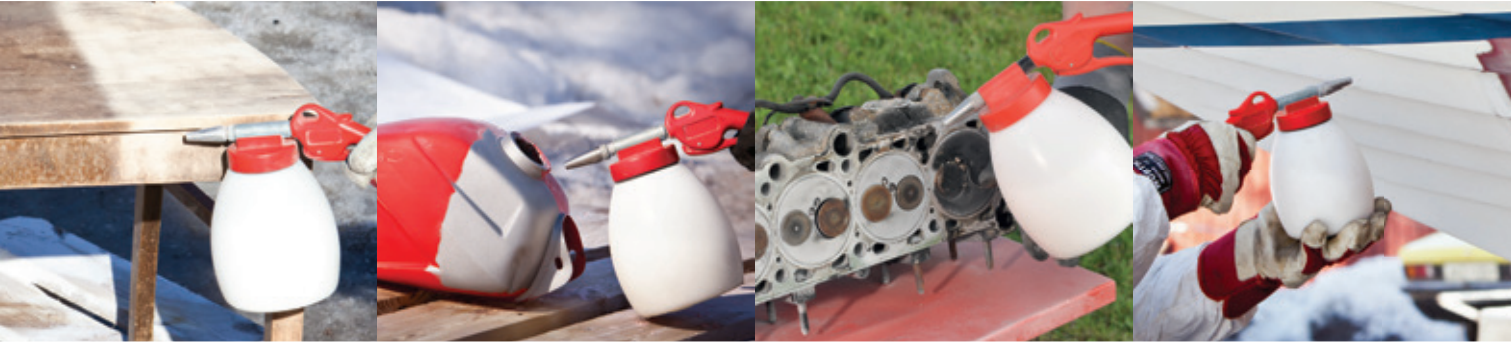

Met de nieuwe Sodablastster 2 zet JWL een veelbelovende opvolger voor de succesvolle JWL Sodablastster in de markt. De multifunctionele tool wordt standaard geleverd met een precisienozzle, plus een praktisch en navulbaar reservoir van 1,2 liter. De Sodablastster 2 is geschikt voor zowel hobby als professioneel gebruik.



Snel, effectief en schadeloos stralen

De belangrijkste eigenschap van de JWL Sodablastster 2 blijft het leveren van een krachtige straling, zonder beschadigingen, verhitting of vervorming aan het materiaal te veroorzaken. Multifunctionaliteit staat hierbij centraal. Binnen enkele seconden worden niet alleen motoronderdelen als kleppen en zuigers, maar ook bootrompen, meubels of plaatstaal volledig gereinigd. En dankzij de milde kracht van soda behoort ook

schade aan glas, rubber of kunststof tot het verleden, waardoor minimale afscherming vereist is.

- Snel en eenvoudig in gebruik
- Verwijdert overtollige verf, lak, roest, coatings of vernis
- Geen beschadigingen bij kwetsbare materialen als glas, hout of rubber
- Milieuvriendelijk dankzij natuurlijk oplosbaar soda
- Beschermt blank metaal tegen roest

Gebruik en veiligheid

De JWL Sodablastster 2 maakt gebruik van soda specifiek voor stralen. Deze soda is niet gevaarlijk, maar kan wel schadelijk zijn bij inademing als stof. Gebruik daarom altijd P2 adembescherming, behoorbescherming en een oog- en gezichtsmasker tijdens gebruik.

Dit product vereist een compressor met een capaciteit van minstens 2,5PK - 180 l/min



Maximale werkdruk:
6 tot 12 bar

Tech Data
60399

Met 1,2 liter reservoir - BSP female

BLAA FLOW BSPP € 145154-000 1/4" 180 (bij 8 bar) 111.05



Tech Data
60039

Soda - 5 liter

BLAA € 320103-000 30.15

Brede POM nozzle - 3 stuks

BLAA € 145955-000 22.05

Stalen precisienozzle

BLAA € 145950-000 22.05

Blaaspistolen



Reinigingspistool



Maximale werkdruk:
6 tot 12 bar

Tech Data
60040



Met 1,2 liter reservoir - rechte blaaspijp - BSP female

BLAA	Nozzle	BSP	FLOW	€
14210013	Met messing nozzle - 260mm	1/4"	100	65.20
14210113	Met messing nozzle - 145mm	1/4"	100	64.15
14213513	Met POM nozzle - 200mm	1/4"	100	55.00

Waspistool

Tech Data
60041



Maximale werkdruk:
6 tot 10 bar

Met Gardena nippel - rechte blaaspijp - BSP female

BLAA	Nozzle	BSP	FLOW	€
14218013	Met POM nozzle	1/4"	380	59.70

Remontluchter

Tech Data
60042



Maximale werkdruk:
6 tot 12 bar



Compleet met slang, nippel en 1,2 liter reservoir - BSP female

BLAA		BSP	FLOW	€
14310013	Remontluchter compleet	1/4"	180	115.75
143155	Reparatiekit - slangaansluiting, rubber nippel, veerontlasting en O-ring	-	-	22.80
143166-000	5x rubber nippels	-	-	72.35

Zandstraalpistool

Tech Data
60043

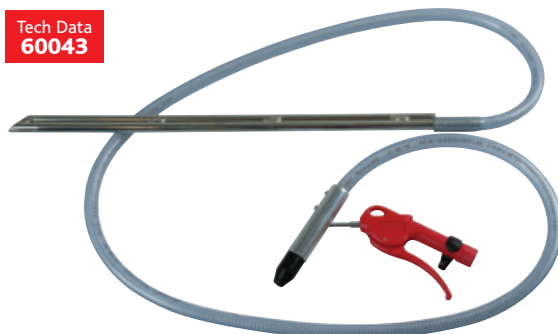

Met zuigbuis - BSP female

BLAA		BSP	FLOW	€
14510200	Zandstraalpistool met zuigbuis	1/4"	450	154.75
14521900	Losse nozzle voor 14510200	-	-	18.30

De JWL gritstraalpistolen zijn geschikt voor korrelgroottes tussen 0,3 en 0,6 mm

Tech Data
60044



Met 1,2 liter reservoir - BSP female

BLAA		BSP	FLOW	€
14510013	Zandstraalpistool 1,2L	1/4"	450	67.40
14520200	Losse nozzle voor 14510013	-	-	11.45

Tectyleerpistool

Tech Data
60045



Voor vloeistof op water- en oliebasis - BSP female

BLAA		BSP	FLOW	€
14613413	Pistool - met plastic zuigbuis	1/4"	180-380	59.60
14610113	Pistool - met metalen zuigbuis	1/4"	180-380	66.00
14610813	Pistool - met 2 zuigbuizen en verlengslang	1/4"	180-380	125.15
14610013	Pistool - met 1,2 liter reservoir	1/4"	180-380	64.15
14611090	Verlengslang ø8 x 900mm	1/4"	100	21.15

Blaaspistolen



Blaaspistolen types AJ-AV

Toepassingen: Bouw, garages, hobby, industrie, installateurs, landbouw, motoren revisie, productie, scheepsbouw, textiel, voedingsmiddelen.

Nozzles: kort, lang, vast of verwisselbaar. Verwisselbare spuitmond M12x1,25.

Venturi nozzles zuigen 2/3 omgevingslucht mee waardoor maximale airflow is gegarandeerd.

Laag geluidsniveau: 63 tot 73 dB.

Temperatuur:
-20°C tot 70°C

Maximale werkdruk:
6 bar

FLOW
Max. 380 L/min

mat
Aluminium of slagvast kunststof

Blaaspistool - box van 10 stuks



Type AJ 13 - gebogen aluminium blaaspip - rood slagvast kunststof

BLAA	OD mm	€
29020613	6	196.20
29020813	8	202.05



Type AK 13 - gebogen aluminium blaaspip - blauw slagvast kunststof

BLAA	OD mm	€
29020013	8	183.90

Type AK 13 heeft een niet verwisselbare nozzle

Blaaspistool - aluminium



Tech Data
10786

Type AA - standaard nozzle - BSP female

BLAA	BSPP	€
29030013	1/4"	24.15



Tech Data
10785

Type AS - veiligheidsnozzle (verwisselbaar) - BSP female

BLAA	BSPP	€
29040013	1/4"	34.55



Type AR - gesinterde metalen nozzle (verwisselbaar) - BSP female

BLAA	BSPP	€
29050013	1/4"	31.55



Tech Data
10788

Type AV - verlengde gebogen metalen blaaspip (verwisselbaar) - BSP female

BLAA	BSPP	€
29060013	1/4"	39.00



Type AT - Venturi nozzle (verwisselbaar) - BSP female

BLAA	BSPP	€
29070013	1/4"	36.30

Hoofdstuk 8 – Gereedschap

KELM™

pneumatiek

Hydrauliek

Snelkoppelingen

Atsluiters

Roestvast staal

Fittingen

Luchtconditionering

Gereedschap

Pneumatiek

Diversen

Malleabele fittingen & staal

Ringleidingssystemen

Slangen

Compressoren

Blaaspistool - slagvast kunststof



Type AN - standaard nozzle - BSP female



29080013

1/4"

18.50



Type AC - gebogen messing vernikkelde blaaspijp - BSP female



29220013

1/4"

21.90



Type AM - zonder nozzle - M12 x 1,25 female nozzleaansluiting - BSP female



29250013

M12 x 1.25

18.80



Type AK - gebogen aluminium blaaspijp - BSP female



29200013

1/4"

18.35



Tech Data
10789

Type AX - Venturi nozzle (verwisselbaar) - BSP female



29230013

1/4"

30.75



Type AZ - messing vernikkelde Star-Tip OSHA veiligheidsnozzle - BSP female



29210013

1/4"

24.50



Type AI - zonder nozzle - 1/8" BSPT female nozzleaansluiting - BSP female



29240013

1/4"

18.30

- **tst** (drukknop) snelkoppelingen & insteeknippels vanaf pagina 257

KELM™
pneumatiek

Hydrauliek

Snel-
koppelingen

Afsluiters

Roestvast
staal

Fittingen

Lucht-
conditionering

Gereedschap

Pneumatiek

Diversen

Malleabele
fittingen &
staal

Ringleiding-
systemen

Slangen

Compressoren

Blaaspistolen



Nozzles

Tech Data
10786



Type KD - standaard nozzle voor aluminium blaaspistool - M12 x 1,25 male



29000012

M12 x 1.25

1.50

Tech Data
10785



Type SD - veiligheidsnozzle voor aluminium blaaspistool - anti-spat en geluiddempend - M12 x 1,25 male



29010012

M12 x 1.25

11.55

Tech Data
10788



Type VR - verlengde gebogen blaaspip voor aluminium blaaspistool - lengte 150mm



29020012

M12 x 1.25

15.65

Tech Data
10787



Type AR - nozzle met gesinterde metalen insert - laag geluidsniveau (63-73 dB) en goede blaaseffectiviteit



29040012

M12 x 1.25

380

63-73

7.55

Tech Data
10789



Type AT - Venturi nozzle - energiebesparend en breed uitblaaseffect



29030012

M12 x 1.25

11.65

Spatscherm



Type ST



29050000

5.35

Blaaspistool - kunststof



Gebogen blaaspip - BSP female



CB01-100GF

1/4"

9.15

Temperatuur: 0°C tot +60°C



Maximale werkdruk: 10 bar



Rechte blaaspip - BSP female



CB01-200GF

1/4"

200

11.80

CB01-300GF

1/4"

300

12.70

KELM™
pneumatiek

Hydrauliek

Snel-
koppelingen

Atsluiters

Roestvast
staal

Fittingen

Lucht-
conditionering

Gereedschap

Pneumatiek

Diversen

Malleabele
fittingen
& staal

Ringleiding-
systemen

Slangen

Compressoren

Blaaspistolen

ASG-1 veiligheidsblaaspistool

 **Temperatuur:**
0°C tot 60°C

 **Maximale werkdruk:**
10 bar

Materiaal: huis: verchromde zinklegering.
nozzle: OSHA-USA messing.
handgreep: verchromd staal met vinyl cover.

 OSHA veiligheidsstandaard: waarschuwing - perslucht kan niet worden gebruikt voor schoonmaak-/reinigingsdoeleinden mits de werkdruk gereduceerd is naar minder dan 30 psi (2 bar) en in combinatie met effectieve persoonlijke beschermingsmiddelen.



Met nozzle



29090013



1/4"



310



10.00

ASG-1 veiligheidsblaaspistool - accessoires

- Tot 33% verhoging van het luchtvolume, maar voldoet alsnog aan OSHA veiligheidsstandaard

Tech Data
20332

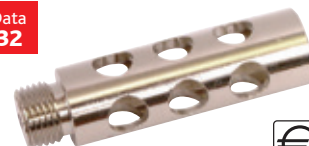

Safety Booster nozzle



ST11



7.55

- Geen veiligheidsnozzle
- Voor gevoelige oppervlakken die door het gebruik van messing nozzles kunnen beschadigen



Rubber nozzle



SAT13



4.75



Verlengde nozzle



ST203



3"



76



10.10

ST206

6"

152.4

10.35

ST208

8"

203.2

13.00

ST210

10"

254.0

15.50

ST212

12"

304.8

16.05

ST216

16"

406.4

25.90

ST218

18"

457.2

34.70

ST224

24"

609.6

28.85

ST230

30"

762.0

32.25

ST236

36"

914.4

38.75

Air Jet nozzle

Toepassing:

- Drogen en/of verwijderen van vloeibare film van oppervlaktes
- Beheersen van oppervlaktecoating
- Afblazen en/of verwijderen van stof en vuil
- Koelen of verwijderen van materialen
- Scheiden van verschillende maten en gewichten

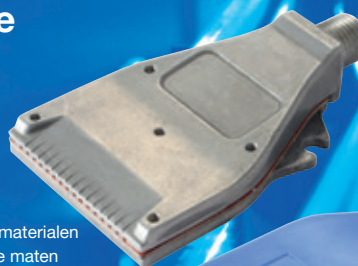

BSP male



AFFN-1/4



1/4"



Aluminium



4.85

PFFN-1/4

1/4"

Kunststof

2.35

Blaaspistolen

Blaaspistool - kunststof

- Lichtgewicht kunststof, ergonomisch design voor extra comfort
- Verstelbare flow, regelbaar door de trekker
- Geschikt voor gebruik met lucht en water
- BG5-PVC inclusief rubber nozzle

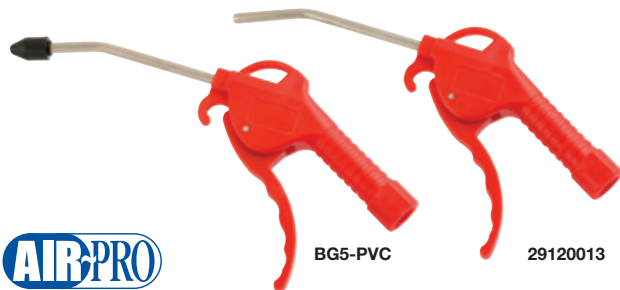

AIR-PRO

BG5-PVC

29120013

Gebogen blaaspijp - BSP female

BLAA				€
29120013	1/4"	-		6.35
BG5-PVC	1/4"	met PVC nozzle		7.15

Materiaal: ABS huis en stalen blaaspijp



Maximale werkdruk:
6 bar

Tech Data
20421



AIR-PRO

Gebogen blaaspijp - BSP female

BLAA			€
LD04-1	1/4"	100	6.90
LD10-1	1/4"	250	10.50
LD13-1	1/4"	330	11.55
LD20-1	1/4"	500	13.70
LD40-1	1/4"	1000	19.25

Heavy duty blaaspistool - messing

- Heavy duty messing constructie voor gebruik in extreme omstandigheden
- Geschikt voor gebruik met lucht en water



AIR-PRO

Met nozzle - BSP female

BLAA		€
BG-718	1/4"	13.20

Blaaspistool - aluminium

- Lichtgewicht aluminium constructie
- Verstelbare flow, regelbaar door de trekker
- Geschikt voor gebruik met lucht, water en reiniger/ontvetter

Tech Data
10726



AIR-PRO

Met nozzle - BSPT male

BLAA			€
29130013	1/4"	350	12.55



Maximale werkdruk:
6 bar



Met nozzle - BSP female

BLAA			€
29101300	1/4"	300	12.15



Maximale werkdruk:
6 bar



Rechte blaaspijp - BSP female

BLAA				€
29111300	1/4"	150	300	16.00

KELM™
pneumatiek

Hydrauliek

Snel-
koppelingen

Atsluiters

Roestvast
staal

Fittingen

Lucht-
conditionering

Gereedschap

Pneumatiek

Diversen

Malleabele
fittings
& staal

Ringleiding-
systemen

Slangen

Compressoren

Blaaspistolen

Airsaver mini blaaspistool



Maximale
werkdruk:
6 bar



BSP female



29051300

1/4"

280

16.45

Profi blaaspistool



Maximale
werkdruk:
6 bar

150mm gebogen blaaspijp - BSP male draaibaar



29151300

Doseerpistool

1/4"

50-250

21.35

Professionele kitspuit

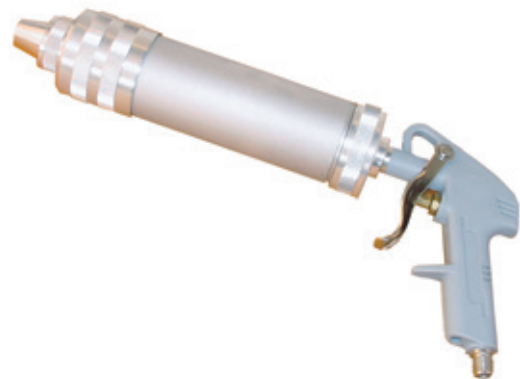

Aluminium - inclusief 3 verschillende messing vernikkelde nozzles



50253A

1,02

2-5

143.20

Waspistool

Pistool: aluminium
Onderbeker: geverfd staal, 1000cc
Nozzle: messing



Maximale
werkdruk:
2-8 bar

Verstelbare nozzle



2900507

300

23.50

Pistool: aluminium
Onderbeker: aluminium, 1000cc met grote vulopening
Nozzle: messing



Maximale
werkdruk:
2-8 bar

Verstelbare nozzle



2900510

300

26.65

tst

- Voor drukknop veiligheidsnelkoppelingen conform ARB0/ISO 4414 zie pagina 257 en 262
- Met Euro, Orion & ISO 6150-C profiel



Bandenpompen

Standaard bandenpomp



Maximale
werkdruk:
1-6 bar



Tech Data
20437

Slang 80cm - manometer Ø-63 - 0-10 bar

6840



1/4"



250



35.10

CEE gekeurde bandenpomp



Maximale
werkdruk:
1-6 bar



Slang 80cm - manometer Ø-63 - 0-10 bar

6840



1/4"



250



48.15

CEE gekeurde bandenpomp - vrachtwagen



Maximale
werkdruk:
1-6 bar



Slang 80cm - manometer Ø-63 - 0-10 bar -
dubbelzijdige pompnippel (30cm)

6840



1/4"



300



73.70

Beschermrubber voor manometer

Ø 63mm

6840

15022063



8.65

3-delige pompnippelset

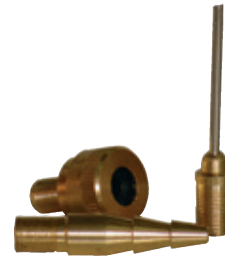

Voor boot, fiets en voetbal - blister

6840

2900504



50-250



11.55

Bandenpompnippel

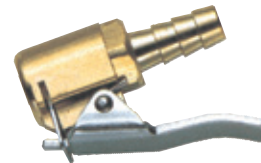

6mm slangpilaar

6840

2900506



6.15

Dubbelzijdige pompnippel - vrachtwagen

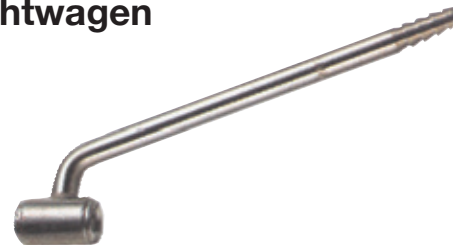

Lengte 30cm - 6 en 8mm slangpilaar

6840

2900501



23.40

KELM™
pneumatiek

Hydrauliek

Snel-
koppelingen

Atsluiters

Roestvast
staal

Fittingen

Lucht-
conditionering

Gereedschap

Pneumatiek

Diversen

Malleabele
fittingen
& staal

Ringleiding-
systemen

Slangen

Compressoren

Standaard bandenpomp

Tech Data
20437



Slang 50cm - manometer Ø-63 & 80 - 0-12 bar

6840



150120-134

1/4"

63

88.10

150130-134

1/4"

80

98.30

Standaard bandenpomp - vrachtwagen



Slang 50cm - manometer Ø-63 & 80 - 0-12 bar - dubbelzijdige pompnippel

6840



150123-134

1/4"

63

116.15

150131-134

1/4"

80

127.65

Heavy duty bandenpomp

Huis: Verzinkt staal en aluminium
Slang: Rubber
Slanglengte: 33cm
Zeer stootvast

Tech Data
1948



Benzinepompmodel - 0-10 bar

6840



LZN313

1/4"

111.65

Digitale bandenpomp

Huis: Verzinkt staal
Slang: Rubber
Slanglengte: 33cm
Dubbelzijdige nippel met W/kwik batterij
Meetbereik: 0,34 tot 13,6 bar



Manometer Ø-63

6840



LEDT102

1/4"

79.70

KELM™
pneumatiek

Hydrauliek

Snel-
koppelingen

Afsluiters

Roestvast
staal

Fittingen

Lucht-
conditionering

Gereedschap

Pneumatiek

Diversen

Malleabele
fittingen
& staal

Ringleiding-
systemen

Slangen

Compressoren

Snijringkoppelingen LL



Maximale werkdruk: 100 bar
Geschikt voor olie en smeertoepassingen



Rechte inschroefkoppeling - staal verzinkt

0382	OD mm		€
LU-1130	4	M6 x 1	5.55
LU-1140	4	M8 x 1	5.55
LU-1150	4	M10 x 1	5.55
LU-1160	4	1/8"	5.55
LU-1170	6	M6 x 1	4.35
LU-1180	6	M8 x 1	4.35
LU-1190	6	M10 x 1	4.35
LU-1200	6	1/8"	4.35
LU-1210	6	1/4"	9.20

RVS



Rechte inschroefkoppeling - RVS AISI-304

0382	OD mm		€
LU-1220SS	6	M6 x 1	28.45
LU-1230SS	6	M8 x 1	28.55
LU-1240SS	6	M10 x 1	28.55
LU-1250SS	6	1/8"	28.55



Knie inschroefkoppeling - staal verzinkt

0382	OD mm		€
LU-1000	4	M6 x 1	9.10
LU-1010	4	M8 x 1	9.10
LU-1020	4	M10 x 1	9.10
LU-1030	4	1/8"	9.10
LU-1040	6	M6 x 1	9.10
LU-1050	6	M8 x 1	9.10
LU-1060	6	M10 x 1	9.10
LU-1070	6	1/8"	9.10
LU-1080	6	1/4"	14.80

RVS



Knie inschroefkoppeling - RVS AISI-304

0382	OD mm		€
LU-1090SS	6	M6 x 1	18.55
LU-1100SS	6	M8 x 1	35.75
LU-1110SS	6	M10 x 1	35.75
LU-1120SS	6	1/8"	35.75

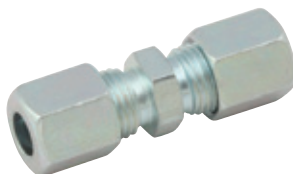

Rechte koppeling - staal verzinkt

0382	OD mm		€
LU-1260	4		9.45
LU-1270	6		7.60

RVS

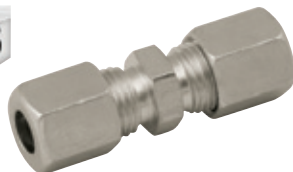

Rechte koppeling - RVS AISI-304

0382	OD mm		€
LU-1290SS	6		34.80



Wartelmoer - staal verzinkt

0382	OD mm		€
LU-1300	4		1.00
LU-1310	6		1.00

RVS



Wartelmoer - RVS AISI-304

0382	OD mm		€
LU-1340SS	6		10.15



Snijring - staal verzinkt

0382	OD mm		€
LU-1320	4		0.90
LU-1330	6		0.90

RVS



Snijring - RVS AISI-304

0382	OD mm		€
LU-1350SS	6		6.70

KELM™
pneumatiek

Hydrauliek

Snel-
koppelingen

Atsluiters

Roestvast
staal

Fittingen

Lucht-
conditionering

Gereedschap

Pneumatiek

Diversen

Malleabele
fittingen
& staal

Ringleiding-
systemen

Slangen

Compressoren

Kegelsmeernippel



Bochtstuk - DIN 71412 - BSPT male

0088		
2017-3829	45ø 1/8"	1.20
2017-3845	45ø 1/4"	2.20
2017-3811	65ø 1/8"	0.85
2017-3787	90ø 1/8"	1.20
2017-3795	90ø 1/4"	2.20



Recht - DIN 71412 - BSPT male

0088		
2017-3738	1/8"	0.65
2017-3746	1/4"	1.35

Vlakmeernippel 16mm



Zeskantkop (15mm A/F) - DIN 3404 - BSP male

0088		
2017-3860	1/8"	1.00
2017-3878	1/4"	1.20



Ronde kop - DIN 3404 - BSP male

0088		
2017-3886	1/8"	1.00
2017-3894	1/4"	1.20

Mondstuk

Voor gebruik met kegelsmeernippels DIN 71412. Bekjes van gehard staal voor een langere levensduur.



Maximale werkdruk:
500 bar



Hydraulisch 4-beks

0088		
2017-3621	37 (met klep)	6.10
2017-3639	37 (zonder klep)	4.25

Voor gebruik met vlakmeernippels (ronde en zeskantkop).



Maximale werkdruk:
400 bar



Duwschuifkop 16mm

0088	
2017-3647	10.25

Voor gebruik met vlakmeernippels (ronde en zeskantkop).



Maximale werkdruk:
400 bar



Trekschuifkop 16mm

0088	
2017-3696	10.25

Voor gebruik met vlakmeernippels (ronde en zeskantkop).



Maximale werkdruk:
400 bar



Scharnierende duwschuifkop 16mm

0088	
2017-3712	17.75

Vetspuiten

- Universele spuit voor gebruik met 400cc cartridges of 500cc bulk vet



Schaarvetspuit

0088	
2017-3506	19.95

- Universele spuit voor gebruik met 400cc cartridges of 500cc bulk vet
- Vaste uitloop en borgmoer, 4-beks connector & vul- en ontluchtingsnippel



Heavy duty schaarvetspuit

0088	
2017-3514	59.75

- Universele spuit voor gebruik met 400cc cartridges of 500cc bulk vet
- Vaste tuit en borgmoer, 4-beks connector



Vetspuit - pistoolgreep

0088	
2017-3555	47.15

- Universele spuit voor gebruik met 400cc cartridges of 500cc bulk vet
- Maximale druk 10 bar
- Luchtinlaat 1/4" BSP female



Luchtbediende vetspuit - pistoolgreep

0088	
2020-7312	46.15

Vetspuitslang



Maximale werkdruk: 400 bar
Barstdruk: 900 bar



Rubber slang met staalinlage -
BSP male



2017-3654	1/8"	300mm (12")	6.25
2017-3662	1/8"	450mm (18")	7.45



Maximale werkdruk: 400 bar
Barstdruk: 900 bar



Polyamide gecoate slang met nylon
textielinlage - BSP male



2017-3670	1/8"	300mm (12")	5.65
2017-3688	1/8"	450mm (18")	6.25



Vast verlengstuk met
4-beks mondstuk



2017-3720	10.45
-----------	-------

Vetpatroon

Multi purpose lagervet voor
conventionele toepassingen.



Lithium No.2



2017-6780	400	5.30
-----------	-----	------

Smeernippels

80-delige assortimentsbox met rechte
smeernippels en bochtstukken



Assortimentsbox - 80 stuks



J9130/80	BSP/BSF/UNF	62.45
J9131/80	M6/M8/M10	62.45

Brandstofapparatuur



Vleugelpomp

Geschikt voor diesel, lichte oliën en water.
Dubbelwerkende vleugelpomp met gietijzeren
huis en messing binnenwerk.

In-line flensaansluitingen.

Keuze uit:

K0 versie: 1/2"

K1 versie: 3/4"

K2 versie: 1"

K5 versie: 1.1/2"

Let op: nooit horizontaal monteren



BSP female



SRG0A	1/2"	80.80
SRG1A	3/4"	98.75
SRG2A	1"	119.35
SRG5A	1.1/2"	249.30

Zelfsluitende metalen vatkraan



BSP male



J4177	1/4"	12.75
-------	------	-------

Sifonpomp

Geschikt voor het pompen van de
meeste vloeistoffen: zuren, alkaline,
antivries, ontvetter, gedistilleerd water,
diesel, benzine, lichte oliën
en oplossingen.



Manueel



HPS25	Voor 5-25 liter vat	7.20
HPS205	Voor 205 liter vat	30.90

Vatpomp

Gietijzeren handpomp met vuilvanger
en 2" BSP vat aansluiting.
Voor olie en benzine.

Tech Data
1172



Manueel - 2" adapter en 1 meter zuigpijp



2042-5658	Tot 25 l/min	50.20
-----------	--------------	-------

KELM™
pneumatiek

Hydrauliek

Snel-
koppelingen

Atsluiters

Roestvast
staal

Fittingen

Lucht-
conditionering

Gereedschap

Pneumatiek

Diversen

Malleabele
fittingen &
staal

Ringleiding-
systemen

Slangen

Compressoren

Verfspuiten

Verfspuit

Toepassing: algemene toepassingen in automotive, bouw, hobby, industrie en scheepsbouw



Belangrijk! Na gebruik zeer grondig reinigen.

Materiaal:

Nozzle: 1.8mm

Aansluiting: 1/4" male

Slangadvies: Min. doorlaat 3/8" = 9.5mm

Flow systeem: Suction

Onderbeker: aluminium 1000 cc met camlock snelsluiting

Lucht L/mm: Gemiddeld 10 cfm. = 280 L/min

Temperatuur:
Advies +20°C tot 30°C



Tech Data
20434

Type W-97 - 3.5-5 bar - aluminium 1000cc onderbeker



W-97



280



99.35

Geschikt voor alle soorten verf. Eenvoudig te bedienen en te reinigen. Unieke inlaat flowregelaar.



Belangrijk! Na gebruik zeer grondig reinigen.

Materiaal:

Regelnaald: messing

Huis: vernikkeld aluminium

Bovenbeker: nylon 680 cc

Nozzle: standaard 1,5mm



Type Prima - 2-3.5 bar - nylon 680cc bovenbeker



2900511



80-200



50.75

Professionele verfspuit

Voor alle soorten verf. Eenvoudig te bedienen en te reinigen. Met grote interne doorlaat waardoor beter fijnregeling bij een relatief lage druk mogelijk is.



Belangrijk! Na gebruik zeer grondig reinigen.

Materiaal:

Regelnaald: messing

Nozzle: 1,4mm. compleet met regelnaald

Bovenbeker: nylon 680 cc



Type UR/S PLUS - 3-3.5 bar - nylon 680cc bovenbeker



2900529



180-330



77.50

KELM™
pneumatiek

Hydrauliek

Snel-
koppelingen

Afsluiters

Roestvast
staal

Fittingen

Lucht-
conditionering

Gereedschap

Pneumatiek

Diversen

Malleabele
fittingen &
staal

Ringleiding-
systemen

Slangen

Compressoren

tst®

- **tst** (drukknop) snelkoppelingen & insteeknippels vanaf pagina 257

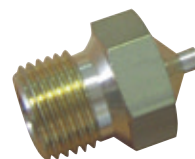

Nozzleset voor verfspuit type UR/S PLUS



2900117S



Nozzle-Sup.ex/MS 1.7mm



38.45

2900122S

Nozzle-Sup.ex/MS 2.2mm

38.45

Verfspuiten

Professionele verfspuit

Industriële verfspuit voor alle soorten verf. Eenvoudig te bedienen en te reinigen. Met grote interne doorlaat waardoor beter fijnregeling bij een relatief lage druk mogelijk is.



Belangrijk! Na gebruik zeer grondig reinigen.

Materiaal:

Regelnaald: messing

Nozzle: 1,7mm compleet met regelnaald

Onderbeker: Aluminium 1000 cc



Type UR-Plus-1000 - 3-4.5 bar - aluminium 1000cc onderbeker



2900509

200-350

103.85

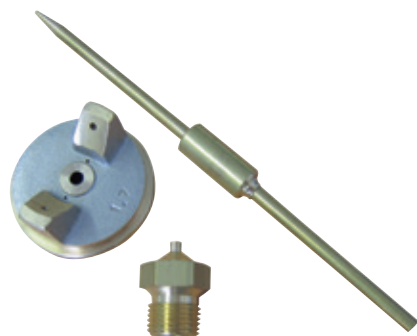

Nozzlezet voor verfspuit type UR-Plus-1000



2900114

Nozzle-SUP.EX/MS 1.4mm

39.35

2900119

Nozzle-SUP.EX/MS 1.9mm

39.35

2900122

Nozzle-SUP.EX/MS 2.2mm

39.35

2900130

Nozzle-SUP.EX/MS 3mm

39.35

Industriële verfspuitkit

Geschikt voor alle soorten verf. Bijzonder geschikt voor verven op waterbasis. Dit innovatieve professionele verfpistool is voorzien van het HVLP (High Volume, Low Pressure) energiebesparende lagedruk systeem. Hierdoor werkt het pistool zeer goed bij een relatief lage druk, waardoor minder verf verloren gaat.

Gebruikt minder energie, werkt kostenbesparend en is minder milieubelastend.

Ergonomisch lichtgewicht ontwerp.

Inclusief manometer. Punt- of vlakstraal instelbaar. Zeer goede fijnregeling.



Belangrijk! Na gebruik zeer grondig reinigen.

Materiaal:

Spuitmond: RVS-AISI-303

Fijnregelnaald: RVS-AISI-303

Veren: RVS

Seals: PTFE

Huis: chemisch vernikkeld aluminium

Bovenbeker: nylon 680 cc

Nozzle: standaard 1,5mm

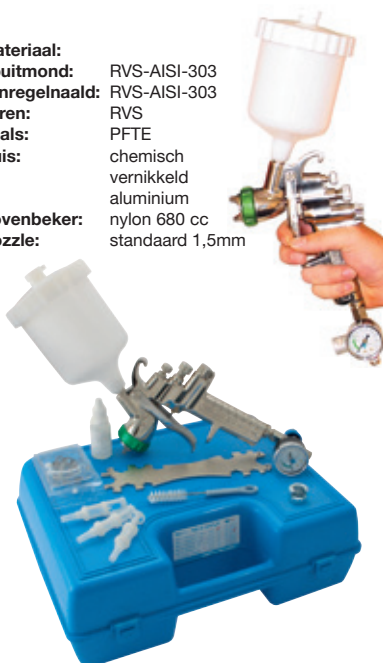

Type 9011 HVLP - 2 bar - nylon 680cc bovenbeker - inclusief drukregelaar met manometer, koffer en div. onderdelen



2900530

200-270

261.15

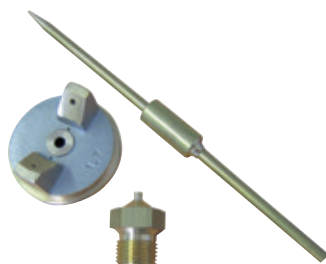

Nozzlezet voor verfspuit type 9011 HVLP



2900215

Nozzle-RVS/SET-530-1.5mm

86.20

2900217

Nozzle-RVS/SET-530-1.7mm

86.20

2900219

Nozzle-RVS/SET-530-1.9mm

86.20

Materiaal:

Spuitmond: RVS-AISI-303.

Fijnregelnaald: RVS-AISI-303.

Veren: RVS.

Seals: PTFE.

Huis: chemisch vernikkeld aluminium.

Onderbeker: aluminium gecoat

1000 cc. met camlock snelsluiting.

standaard 1,7 mm.

Nozzle:

standaard 1,7 mm.



Type 9010 HVLP - 2 bar - aluminium 1000cc onderbeker - inclusief drukregelaar met manometer, koffer en div. onderdelen



2900532

314.00

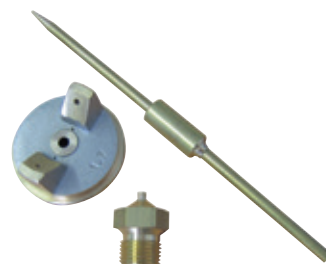

Nozzlezet voor verfspuit type 9010 HVLP



2900415

Nozzle-RVS/SET-532-1.5mm

91.65

2900417

Nozzle-RVS/SET-532-1.7mm

91.65

2900419

Nozzle-RVS/SET-532-1.9mm

91.65

KELM™

pneumatiek

Hydrauliek

Snel-

koppelingen

Afsluiters

Roestvast

staal

Fittingen

Lucht-

conditionering

Gereedschap

Pneumatiek

Diversen

Malleabele

fittings

& staal

Ringleiding-

systemen

Slangen

Compressoren

- Inlaat: 1/2" BSP
- Automatische uitschakeling
- Instelbaar spuitpatroon
- Het rubber geïsoleerde huis en greep laat geen strepen of krassen achter
- Vergrendelbare trekker
- Niet geschikt voor gebruik met stoom

1/2" BSP female inlaat

6805

BSPP

25 bar

Blauw
Rood

€

WASH-GUN

1/2"

25

Blauw

44.95

REDWASH-GUN

1/2"

25

Rood

45.55



Temperatuur:
+50°C



Maximale
werkdruk:
25 bar



Heavy Duty messing spuitpistolen

Heavy Duty RVS

hygiënische spuitpistolen



- Inlaat: 1/2" BSP female
- Automatische uitschakeling
- Instelbaar spuitpatroon
- Het rubber geïsoleerde huis en greep laat geen strepen of krassen achter
- Vergrendelbare trekker

1/2" BSP female inlaat

6805	BSPP	bar		€
HYGWASH-GUNR	1/2"	25	Rood	126.50
HYGWASH-GUNG	1/2"	25	Groen	126.50
HYGWASH-GUN	1/2"	25	Wit	126.50



Temperatuur:
+90°C



Maximale
werkdruk:
25 bar

Jetwash hogedrukslang - blauw



- Olie-, slijtage-, ozon- en weerbestendig synthetisch gepinprikt rubber. Staaldraadinlagen met hoge treksterkte.

Temperatuur:
-40°C tot +155°C

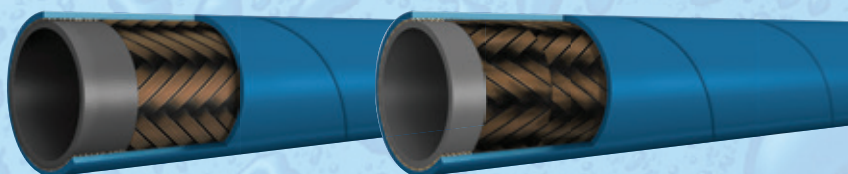

1 staaldraadinlage

2 staaldraadinlagen

1 staaldraadinlage - 10 meter rol

0303			
PWBLUE-04-10-R1	1/4"	225	39.95
PWBLUE-05-10-R1	5/16"	215	48.80
PWBLUE-06-10-R1	3/8"	180	67.65

1 staaldraadinlage - 25 meter rol

0303			
PWBLUE-04-25-R1	1/4"	225	151.70
PWBLUE-05-25-R1	5/16"	215	185.40
PWBLUE-06-25-R1	3/8"	180	218.85

2 staaldraadinlagen - 100 meter rol

0303			
PWBLUE-04-100-R2	1/4"	400	764.55
PWBLUE-05-100-R2	5/16"	350	1008.10
PWBLUE-06-100-R2	3/8"	330	1150.85

Jetwash hogedrukslang - zwart



- Olie-, slijtage-, ozon- en weerbestendig synthetisch gepinprikt rubber. Staaldraadinlagen met hoge treksterkte.

Temperatuur:
-40°C tot +155°C

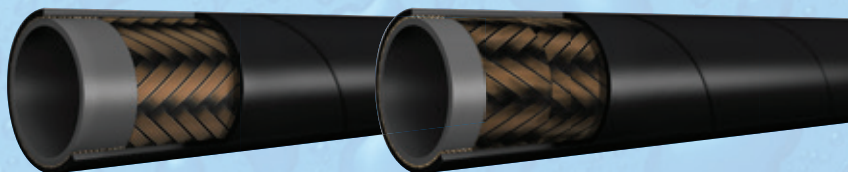

1 staaldraadinlage

2 staaldraadinlagen

1 staaldraadinlage - 10 meter rol

0303			
PWBLACK-04-10-R1	1/4"	225	60.35
PWBLACK-05-10-R1	5/16"	215	75.55
PWBLACK-06-10-R1	3/8"	180	86.60

1 staaldraadinlage - 25 meter rol

0303			
PWBLACK-04-25-R1	1/4"	225	145.40
PWBLACK-05-25-R1	5/16"	215	177.25
PWBLACK-06-25-R1	3/8"	180	209.30

2 staaldraadinlagen - 100 meter rol

0303			
PWBLACK-04-100R2	1/4"	400	724.60
PWBLACK-05-100R2	5/16"	350	902.40
PWBLACK-06-100R2	3/8"	330	1040.25

Jetwash hogedrukslang - geassembleerd

- Olie-, slijtage-, ozon- en weerbestendig synthetisch gepinprikt rubber. Staaldraadinlagen met hoge treksterkte.
- Speciaal synthetisch rubber voor hoge temperaturen.
- Blauwe slang is geschikt voor omgevingen waar non-marking slang een vereiste is (zoals zuivelomgeving)
- Zwarte slang is geschikt voor standaard reinigingstoepassingen (zoals autowasstraat)



10 meter 1 staaldraadinlage 1/4" ID - 1/4" BSP female

0303				€
1PWLA-14N	1/4"	225	Zwart	72.30

10 meter 1 staaldraadinlage 3/8" ID - 3/8" BSP female

0303				€
1PWLA-38B	3/8"	180	Blauw	64.60
1PWLA-38N	3/8"	180	Zwart	59.95

10 meter 1 staaldraadinlage 3/8" ID - 3/8" BSP male x female

0303				€
1PWLA-M-F-38N	3/8"	180	Zwart	120.35



10 meter 2 staaldraadinlagen 3/8" ID - 3/8" BSP female

0303				€
2PWLA-38B	3/8"	330	Blauw	79.40
2PWLA-38N	3/8"	330	Zwart	122.75

10 meter 2 staaldraadinlagen 3/8 ID - M22x1,5 female

0303				€
2PWLA-K-K-38B	3/8"	330	Blauw	132.45
2PWLA-K-K-38N	3/8"	330	Zwart	122.55

10 meter 2 staaldraadinlagen 3/8 ID - M22x1,5 female x 3/8" BSP female

0303				€
2PWLA-K-F-38B	3/8"	330	Blauw	93.25
2PWLA-K-F-38N	3/8"	330	Zwart	89.35

10 meter 2 staaldraadinlagen 3/8 ID - M22x1,5 female x 3/8" BSP male

0303				€
2PWLA-K-M-38B	3/8"	330	Blauw	129.55
2PWLA-K-M-38N	3/8"	330	Zwart	89.90

Jetwash slangpilaar



M22x1,5 female

0303	To Suit Hose I.D.	€
JWF-22-04	1/4"	3.75
JWF-22-05	5/16"	3.60
JWF-22-06	3/8"	3.95



Male adapter

0303	To Suit Hose I.D.	€
JWM-04	1/4"	11.05
JWM-05	5/16"	11.45
JWM-06	3/8"	11.25

Knikbeschermer

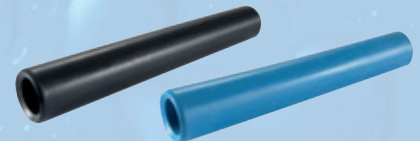

Voor slang met 1 of 2 staaldraadinlagen

0303		To Suit Hose I.D.	€
1/4-BLUE-CUFF	Blauw	1/4"	1.15
1/4-BLACK-CUFF	Zwart	1/4"	1.40
3/8-BLUE-CUFF	Blauw	3/8"	1.20
3/8-BLACK-CUFF	Zwart	3/8"	1.15

KELM™
pneumatiek

Hydrauliek

Snel-
koppelingen

Atsluiters

Roestvast
staal

Fittingen

Lucht-
conditionering

Gereedschap

Pneumatiek

Diversen

Malleabele
fittings
& staal

Ringleiding-
systemen

Slangen

Compressoren

SPUITPISTOLEN MET LANS



Temperatuur:
150°C

Rechte lans - dichte isolatie -
3/8" BSP inlaat

1369				
------	--	--	--	--

PRESSURE-LANCESH	3/8"	430	280	61.95
PRESSURE-LANCE	3/8"	900	280	48.25

Rechte lans - open isolatie -
3/8" BSP inlaat

1369				
------	--	--	--	--

PRESSURE-L500V	3/8"	500	280	50.20
PRESSURE-L635V	3/8"	635	280	51.55
PRESSURE-L760V	3/8"	760	280	52.50
PRESSURE-L900V	3/8"	900	280	54.20

15° gebogen lans - dichte isolatie -
3/8" BSP inlaat

1369				
------	--	--	--	--

PRESSURE-LANCE15	3/8"	900	280	62.65
-------------------------	------	-----	-----	--------------

15° gebogen lans - open
isolatie - 3/8" BSP inlaat

1369				
------	--	--	--	--

PRESSURE-L15500V	3/8"	500	280	50.40
PRESSURE-L15635V	3/8"	635	280	51.80
PRESSURE-L15760V	3/8"	760	280	53.10
PRESSURE-L15900V	3/8"	900	280	54.50

- Maximale flow: 25 l/min
- 25° spuitpatroon
- Open of dichte isolatie
- Recht of 15° gebogen
- Lengte 430 tot 900mm

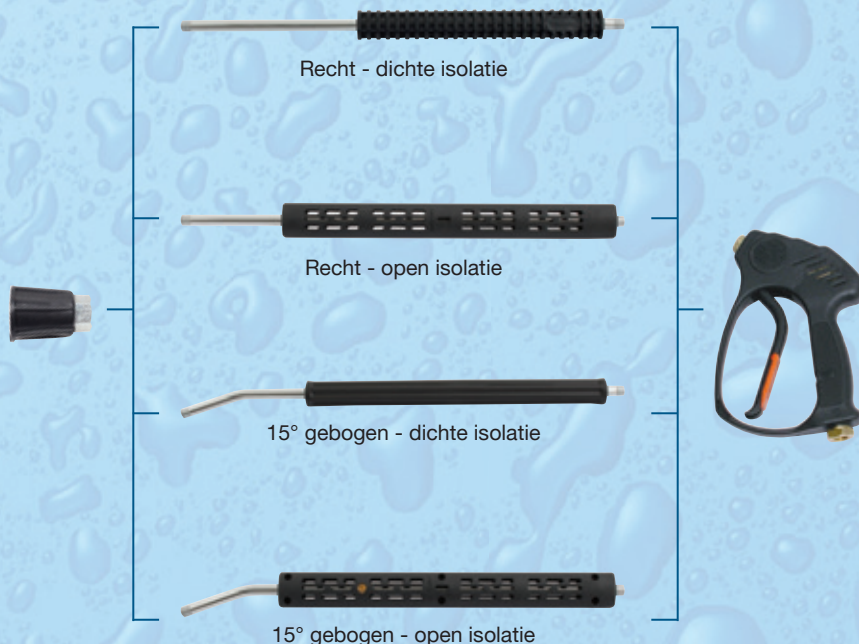

- Maximale flow: 40 l/min
- 15° spuitpatroon
- Open of dichte isolatie
- Nozzlehouder en beschermer
- Verstelbare lage-/hogedruknozzle
- Extra handgreep zorgt voor meer controle tijdens het reinigen

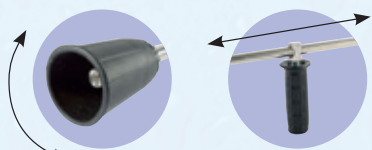

Verstelbaar



Temperatuur:
150°C

Rechte lans met handgreep -
dichte isolatie - 3/8" BSP inlaat

1369				
------	--	--	--	--

CD-2502	3/8"	900	280	90.20
----------------	------	-----	-----	--------------

Rechte lans met handgreep -
open isolatie - 3/8" BSP inlaat

1369				
------	--	--	--	--

CD-2501	3/8"	900	280	91.95
----------------	------	-----	-----	--------------

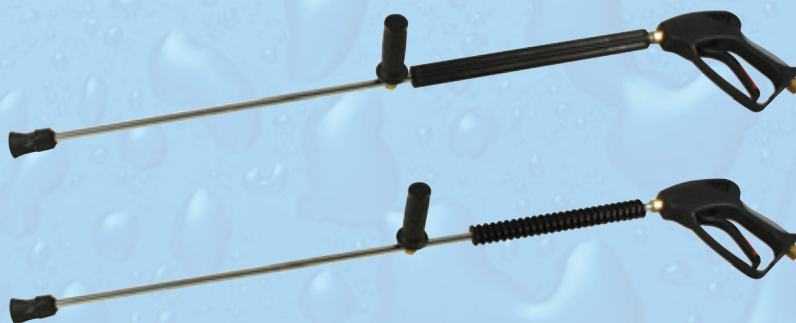

Spuitpistolen met lans

FLOW 40 l/min



Rechte korte lans - hoge flow - 3/8" BSP inlaat

1369 **BSPP** **L** **bar** **€**
PWLA1 3/8" 400 250 80.50

FLOW 40 l/min



Rechte lans - hoge flow - BSP inlaat - 3/8" BSP inlaat

1369 **BSPP** **L** **bar** **€**
PWLA2 3/8" 900 250 77.20

FLOW 25 l/min



Gebogen dubbele lans - lage flow - 3/8" BSP inlaat

1369 **BSPP** **L** **bar** **€**
PWLA3 3/8" 1060 280 100.25

FLOW 40 l/min

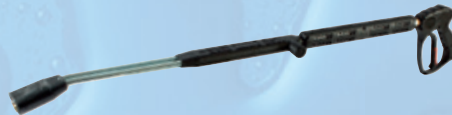

Gebogen dubbele lans - hoge flow - 3/8" BSP inlaat

1369 **BSPP** **L** **bar** **€**
PWLA4 3/8" 1060 250 99.30

FLOW 25 l/min



Gebogen dubbele lans met handgreep - lage flow - 3/8" BSP inlaat

1369 **BSPP** **L** **bar** **€**
PWLA5 3/8" 1060 280 94.50

FLOW 40 l/min



Gebogen dubbele lans met handgreep - hoge flow - 3/8" BSP inlaat

1369 **BSPP** **L** **bar** **€**
PWLA6 3/8" 1060 250 113.15

Algemene max. temperatuur: 150°C

Samengesteld spuitpistool met 900mm verzinkte rechte lans. Inclusief dicht isolatiedeel, nozzlehouder en beschermer.

FLOW 40 l/min



Rechte lans - hoge flow en hogedruk - 3/8" BSP inlaat

1369 **BSPP** **L** **bar** **€**
1002-0038 3/8" 900 310 88.15

Hogedruknozzles

1/4" NPT male

MTWK		bar	@50bar LPM	@100bar LPM	@150bar LPM	€
HPN3015	15° Straal	500	5.3	6.8	8.3	14.50
HPN3515	15° Straal	500	6	7.8	9.5	14.50
HPN4015	15° Straal	500	7.3	9.4	11.5	14.50
HPN4515	15° Straal	500	7.1	10.2	12.2	14.50
HPN5015	15° Straal	500	8.7	11.3	13.8	14.50
HPN5515	15° Straal	500	9.6	12.4	15.2	14.50
HPN6015	15° Straal	500	10.4	13.6	16.7	14.50
HPN6515	15° Straal	500	11.3	14.7	17.4	14.50
HPN3025	25° Straal	500	5.3	6.8	8.3	14.50
HPN3525	25° Straal	500	6	7.8	9.5	14.50
HPN4025	25° Straal	500	7.3	9.4	11.5	14.50
HPN4525	25° Straal	500	7.1	10.2	12.2	14.50
HPN5025	25° Straal	500	8.7	11.3	13.8	14.50
HPN5525	25° Straal	500	9.6	12.4	15.2	14.50
HPN6025	25° Straal	500	10.4	13.6	16.7	14.50
HPN6525	25° Straal	500	11.3	14.7	17.4	14.50

Hogedruk watersnelkoppeling

Maximale werkdruk: 210 bar

Uitwisselbaar met: Nito hogedruk watersnelkoppelingen 40 serie watersnelkoppelingen

Snelkoppeling - BSP female

1369 **€**
PWQRC-38 3/8" 17.20

Insteeknippel - BSP female

1369 **€**
PWQRP-38 3/8" 8.35

KELM™ pneumatiek

Hydrauliek

Snelkoppelingen

Atsluiters

Roestvast staal

Fittingen

Luchtconditionering

Gereedschap

Pneumatiek

Diversen

Malleabele fittingen & staal

Ringleidingssystemen

Slangen

Compressoren

Spuitpistolen met lans

FLOW 25 l/min

RVS

Gebogen dubbele RVS lans - lage flow - 3/8" BSP inlaat

1369	BSPP	bar	€
PWLA7	3/8"	280	138.95

FLOW 40 l/min

RVS

Gebogen dubbele RVS lans - hoge flow - 3/8" BSP inlaat

1369	BSPP	bar	€
PWLA8	3/8"	250	152.45

FLOW 25 l/min

RVS

Gebogen dubbele RVS lans met handgreep - lage flow - 3/8" BSP inlaat

1369	BSPP	bar	€
PWLA9	3/8"	280	146.50

FLOW 40 l/min

RVS

Gebogen dubbele RVS lans met handgreep - hoge flow - 3/8" BSP inlaat

1369	BSPP	bar	€
PWLA10	3/8"	250	140.30

Hogedrukpistolen

Max. temperatuur: 150°C

Max. werkdruk: 280 bar

3/8" BSP inlaat - 30 l/min

1369	Inlet	Outlet	€
ST900	3/8"	1/4"	28.90

Max. temperatuur: 150°C

Max. werkdruk: 280 bar

Soft grip - 3/8" BSP inlaat - 40 l/min

1369	Inlet	Outlet	€
CDQ1500	3/8"	1/4"	45.55

Max. temperatuur: 100°C

Max. werkdruk: 190 bar

3/8" BSP inlaat - 32 l/min

1369	Inlet	Outlet	€
ST-2	3/8"	1/4"	37.90

Max. temperatuur: 150°C

Max. werkdruk: 310 bar

3/8" BSP inlaat - 30 l/min

1369	Inlet	Outlet	€
ST-5	3/8"	1/4"	33.60

Max. temperatuur: 150°C

Max. werkdruk: 280 bar

3/8" BSP inlaat - 25 l/min

1369	Inlet	Outlet	€
CDQ1900	3/8"	1/4"	41.30

Max. temperatuur: 150°C

Max. werkdruk: 345 bar

In-line - 3/8" BSP inlaat - 45 l/min

1369	Inlet	Outlet	€
CDQ2100	3/8"	1/4"	56.65

Max. temperatuur: 150°C

Max. werkdruk: 345 bar

3/8" BSP inlaat - 45 l/min

1369	Inlet	Outlet	€
CDQ1600	3/8"	1/4"	50.00

Spuitlansen

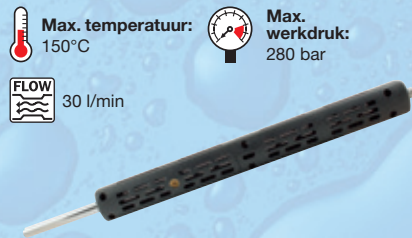

Rechte lans - open isolatie - 1/4" BSPT inlaat/uitlaat

1369	L mm	€
BD-20	500	15.90
BD-25	635	17.10
BD-30	760	18.55
BD-36	900	20.50

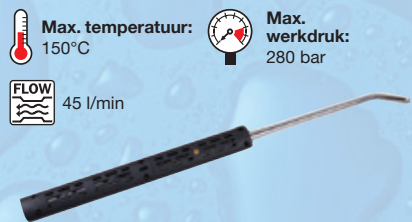

Gebogen lans - open isolatie - 1/4" BSPT inlaat/uitlaat

1369	L mm	€
CDBB-20	500	15.90
CDBB-25	635	17.50
CDBB-30	760	18.85
CDBB-36	900	20.85



Rechte lans - dichte isolatie - 1/4" BSPT inlaat/uitlaat

1369	L mm	€
BMG-20	500	11.05
BMG-25	635	12.55
BMG-30	760	14.15
BMG-36	900	16.10

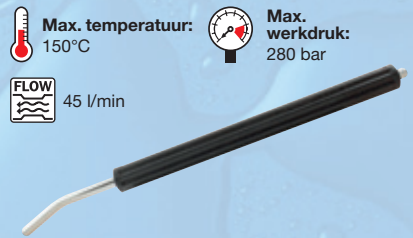

Gebogen lans - dichte isolatie - 1/4" BSPT inlaat/uitlaat

1369	L mm	€
CDBJ-20	500	13.00
CDBJ-25	635	14.50
CDBJ-30	760	16.20
CDBJ-36	900	18.25



Dubbele rechte lans - dichte isolatie - 1/4" BSPT inlaat/uitlaat

1369	L mm	€
CDBU-42	1065	25.65
CDBU-47	1190	27.25
CDBU-50	1270	28.55



Dubbele gebogen lans - dichte isolatie - 1/4" BSPT inlaat/uitlaat

1369	L mm	€
CDBV-42	1065	21.45
CDBV-47	1190	23.15
CDBV-50	1270	24.05

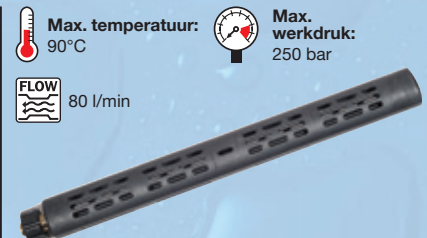

Rechte lans - open isolatie - 1/4" BSPT inlaat/M22 uitlaat

1369	L mm	€
BA-16	405	20.10
BA-18	457	20.85
BA-20	508	21.45



Rechte lans - dichte isolatie - 1/4" BSPT inlaat/M22 uitlaat

1369	L mm	€
BC-13	330	14.50
BC-15	380	15.35
BC-18	457	16.20
BC-20	508	16.85



Verstelbare M22 male extensie & nozzle

1369	L mm	€
CDBL-15	375	20.50

- KELM™ pneumatiek
- Hydrauliek
- Snelkoppelingen
- Atsluiters
- Roestvast staal
- Fittingen
- Luchtconditionering
- Gereedschap**
- Pneumatiek
- Diversen
- Malleabele fittingen & staal
- Ringleidingssystemen
- Slangen
- Compressoren

Dubbele spuitlansen

Max. temperatuur: 60°C

Max. werkdruk: 250 bar

45 l/min



RVS

Dubbele gebogen RVS lans

1369
SSTLTC 1/4" 106.20



RVS

Dubbele gebogen RVS lans met handgreep

1369
SSTLH 1/4" 112.80



Dubbele gebogen verzinkte lans met handgreep

1369
ZPTLH 1/4" 73.00



Dubbele gebogen verzinkte lans

1369
ZPTLTC 1/4" 66.40

Spuitlansen

Standaard geleverd met 1/4" BSP female nozzlehouder & beschermer. Inlaat 1/4" BSP male.

Max. temperatuur: +150°C

Max. werkdruk: 250 bar

40 l/min



Rechte verzinkte lans - dichte isolatie

1369		No. of Grips			
SL-2	900	1	280	40	16.95



Gebogen verzinkte lans - dichte isolatie

1369		No. of Grips			
SL-3	900	1	280	40	27.40
SL-4	1200	2	280	40	39.60

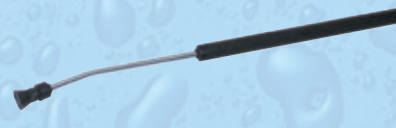

Gebogen verzinkte lans - holle isolatie

1369		No. of Grips			
SL-5	700	1	280	40	32.25



Gebogen verzinkte lans - open isolatie

1369		No. of Grips			
SL-7	900	1	280	40	21.70
SL-8	900	2	280	40	42.05

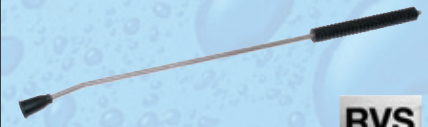

RVS

Gebogen RVS lans - dichte isolatie

1369		No. of Grips			
SL-10	900	1	280	40	44.35
SL-11	1200	1	280	40	44.35



RVS

Rechte RVS lans - dichte isolatie

1369		No. of Grips			
SL-12	Schroefbev. 900	1	280	40	51.45
SL-13	Schuifbev. 900	1	280	40	31.20

Heavy duty schuimplans

- Eenvoudig aan te sluiten op een hogedrukpistool of lans
- Creëert een egale schuimplaag op het te reinigen object
- 1/4" BSP male aansluiting
- 1 liter reservoir
- Nozzle met variabele spuihoek
- Met doseerknop

Temperatuur: +60°C

Maximale werkdruk: 275 bar



BSP male

1369
FGB-1 1/4" 51.40

Nozzlehouders

Max. temperatuur: 60°C Max. werkdruk: 250 bar

FLOW 36 l/min



Staal - 1/4" female

1369 CDH005 1/4" € 3.80

Max. temperatuur: 90°C Max. werkdruk: 250 bar

FLOW 36 l/min



Staal - 1/4" female - verstelbaar met beschermer

1369 CDH004 1/4" € 7.20

Max. temperatuur: 90°C Max. werkdruk: 250 bar

FLOW 36 l/min



Messing - 1/4" female

1369 CDH002 1/4" € 24.05

Max. temperatuur: 90°C Max. werkdruk: 250 bar

FLOW 36 l/min



Messing - 1/4" female - verstelbaar met beschermer

1369 CDH006 1/4" € 27.25

Max. temperatuur: 90°C Max. werkdruk: 250 bar

FLOW 36 l/min



Messing - 1/4" female - kort

1369 CDH001 1/4" € 4.65

Turbo nozzles - roterend

Max. temperatuur: 90°C Max. werkdruk: 345 bar

FLOW 45 l/min



1/4" BSP female

1369 9202L 1/4" BSPP € 102.55

Max. temperatuur: 90°C Max. werkdruk: 280 bar

FLOW 45 l/min



1/4" BSP female

1369 9203L 1/4" BSPP € 73.55

Snelkoppeling

Temperatuur:
+160°C



Messing vernikkeld - Kew profiel - BSP female

C390-17N	3/8"	310	60	17.15

Schroefsnelkoppeling

Temperatuur:
+160°C



Staal verzinkt - BSP/metrisch female - zuiger diameter 14mm

SQ22F17GF	M22x1.5 - 3/8"	280	40	7.85

RVS



RVS - Kew profiel - BSP female

CSS390-17N	3/8"	400	60	49.95

Messing - BSP/metrisch male



SQ22M17GM	M22x1.5 - 3/8"	280	40	3.95

Insteeknippel



Staal verzinkt - Kew profiel - BSP female

HPN390-17N	3/8"	310	60	5.00

Staal verzinkt - tweedelig - BSP/metrisch female



QS22F13F	M22x1.5 - 1/4"	280	40	7.45

RVS



RVS - Kew profiel - BSP female

HPNSS390-17N	3/8"	400	60	14.45

Compacte draaibare koppeling

Temperatuur:
+150°C



Messing - BSP male/female

21-049	3/8"	280	40	11.65

KELM™
pneumatiek

Hydrauliek

Snel-
koppelingen

Afsluiters

Roestvast
staal

Fittingen

Lucht-
conditionering

Gereedschap

Pneumatiek

Diversen

Malleabele
fittingen
& staal

Ringleiding-
systemen

Slangen

Compressoren

Hogedrukreiniging



Topkwaliteit componenten voor hogedrukreinigers en de autowasindustrie.
 Het productieproces en kwaliteitscontroletraject voldoet aan zeer hoge eisen.
 De opgenomen onderdelen zijn uitwisselbaar met de meeste merken hogedrukreinigers.
 Toepasbaar in autowasstraten en industriële reinigingsprocessen.

Iride hogedruk reinigingspistolen

Max temperatuur:
150°C



Standaard - inlaat/uitlaat BSP female

WG280-10	3/8"	1/4"	280	30	43.25



Standaard - swivel inlaat/BSP female uitlaat

WG280-13	3/8"	1/4"	280	30	62.55
WG280-12	M22	1/4"	280	30	62.55

Hogedruk reinigingspistolen



Inlaat BSP female/uitlaat KW kogelsnelkoppeling

WG280-17N	3/8"	KC35	280	30	103.95



Inlaat swivel BSP female/uitlaat M22x1.5 male

WG280-19N	M22	M22	310	45	77.45

Hoofdstuk 8 – Gereedschap

KELM™ pneumatiek
Hydrauliek
Snelkoppelingen
Atsluiters
Roestvast staal
Fittingen
Luchtconditionering
Gereedschap
Pneumatiek
Diversen
Malleabele fittingen & staal
Ringleidingssystemen
Slangen
Compressoren

RVS spuitlans (underbody) - zonder isolatie

Max
temperatuur:
150°C



M22x1.5 inlaat - 1/4" NPT female uitlaat

UBL-1	M22 x 1.5	1/4"	280	1	41.85

Nozzlehouder (retainer)

Messing - versterkt kunststof
(voor Kärcher spuitlans)



TIP18	M18 Fem	3.30

MT2 spuitlans - met open isolatie

Max
temperatuur:
150°C



RVS lans - inlaat 1/4" BSP male - uitlaat 1/4" NPT female

LGV1-700	700	280	40	23.95
LGV1-1500	1500	280	40	40.05

Andere lengtes tot 2000 mm zijn op aanvraag leverbaar.

Max
temperatuur:
150°C



RVS lans - inlaat RVS spigot KW insteeknippel - uitlaat 1/4" NPT female

KEW2-700	700	280	40	48.40

Andere lengtes tot 2000 mm zijn op aanvraag leverbaar.

MT3 spuitlans - met dichte isolatie

Max
temperatuur:
150°C



RVS lans - inlaat 1/4" BSP male - uitlaat 1/4" NPT female

KAMT3-700	700	280	40	19.60

Andere lengtes tot 2000 mm zijn op aanvraag leverbaar.

Max
temperatuur:
150°C



Dubbele RVS lans - inlaat 1/4" BSP male - uitlaat 1/4" NPT female

DLMT2H-1060	1060	280	40	73.00

Dubbele spuitlans - met open isolatie en greep

Max
temperatuur:
150°C



RVS lans - swivel inlaat Kärcher M22x1.5 - uitlaat 1/4" NPT female

KADLH-1200	1100	280	40	93.55

Andere doorlaten op aanvraag: 030, 035, 040, 050, 055, 060, 065, 070



RVS lans - inlaat RVS spigot KW insteeknippel - uitlaat NPT female

KEWDLH-1200N	1060	250	40	101.70

Hogedrukreiniging



Schuimverbeteraar voor borstels



Inlaat 1/4" BSP male - uitlaat 1/4" NPT female - opening 2,5mm



FT13

280

41.85

Turbo nozzle - 045

Max
temperatuur:
60°C



Inlaat 1/4" BSP female



TN160-1345

160

45.10

Andere doorlaten zijn op aanvraag leverbaar: 025, 030, 035, 040.

Max
temperatuur:
100°C



Inlaat 1/4" BSP female



TRN210-1345

210

105.30

Andere doorlaten zijn op aanvraag leverbaar: 020, 025, 030, 035, 040, 050, 055, 060, 065.

Max
temperatuur:
100°C



Inlaat 1/4" BSP female



TN280-1345

280

130.15

Andere doorlaten zijn op aanvraag leverbaar: 030, 035, 040, 050, 055, 060, 065, 070.

Borstellans - met dichte isolatie

Max
temperatuur:
150°C



Zonder borstel - inlaat/uitlaat 1/4" BSP male



LB13-700

700

280

43.35

Autowasborstel

Max
temperatuur:
80°C



Natuurlijk chinees varkenshaar - 1/4" BSP female



CWB-13F

1/4"

60

68.40

CWB1-13F

1/4"

90

95.15

Max
temperatuur:
80°C



Nylon borstelhaar - 1/4" BSP female



RF80-13

1/4"

Nylon

20.10

Waterfilter - 300 micron



Aluminium - inlaat 1/2" BSP female - uitlaat 1/2" BSP male



AWF300-21

1/2" fem x 1/2" male

25.40

Inline waterfilter - 177 micron



Kunststof - inlaat en uitlaat 1/2" BSP female



ILWF300-21

1/2" fem x 1/2" fem

20.10

KELM™
pneumatiek

Hydrauliek

Snel-
koppelingen

Atsluiters

Roestvast
staal

Fittingen

Lucht-
conditionering

Gereedschap

Pneumatiek

Diversen

Malleabele
fittingen
& staal

Ringleiding-
systemen

Slangen

Compressoren

Hyperjet-Plus instelbare spuitkop

Max
temperatuur:
150°C



Inlaat 1/4" BSP female - uitlaat 1/4" NPT female - geschikt voor de RVS HPN nozzles, HPN serie 80 - 210 bar



HJ250-1313 250 18.50

Meest gevraagde type!

Hogedruknozzle voor buisreiniging

Max
temperatuur:
150°C



RVS - inlaat 1/4" BSP female



NPC210-6513 3+1 x 0,8mm - 055 12.80



Messing - inlaat 1/4" BSP male



NPC210-0513 3+1 x 0,8mm - 055 10.85

Andere doorlaten op aanvraag: 1.0, 1.1
Andere aansluiting op aanvraag: 1/8" Female

Roterende nozzle voor buisreiniging

Max
temperatuur:
130°C



Inlaat 1/4" BSP female



RN-1308 250 3 x 0,8mm - 045 24.70

Lagedruknozzle

Max
temperatuur:
100°C

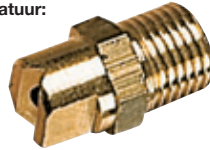

Messing - inlaat 1/4" NPT male



LPN50-13 50 4.25

BP9 instelbare ontlastklep met by-pass

Max
temperatuur:
90°C



Inlaat, uitlaat en by-pass 3/8" BSP female - paneelmontage



ULV200-1 200 30 84.20

210 & 350 bar kleppen zijn op aanvraag leverbaar

CK500 hogedruk terugslagklep

Max
temperatuur:
90°C



Messing - BSP female



CKV310-13 1/4" 310 20 21.85

CKV310-17 3/8" 310 40 21.80

CKV250-21 1/2" 250 60 23.25

SL swivel koppeling

Max
temperatuur:
150°C



Maximale
werkdruk:
280 bar



Rechte rotatiekoppeling



SWL1717 3/8" fem x 3/8" male 40 23.25

Spuitpistolen



Europees fabriekaat

Ergonomisch:

De waterpistolen zijn zeer gebruiksvriendelijk, vooral bij professioneel langdurig gebruik. Ze hebben een uitstekende ergonomische vormgeving. Maximale flow door VOLLE doorlaat.

Toepassing:

Algemene industrie, voedingsmiddelenindustrie, schepen & zeer professioneel privé gebruik. Water, chemicaliën, voedingsmiddelen, perslucht, zuren & logen, enz.

Garantie:

5 jaar.

Advies:

Door te reinigen met hoge druk wordt vaak het vuil verplaatst (tegen de wand, het plafond enz.) Bij middendruk & lagedruk is de tijd de positieve factor die het vuil afvoert.

Nito snelkoppelingen: Dit uitgebreide watersnelkoppelingen assortiment in messing en roestvast staal vindt u in hoofdstuk 3.

Nito II heavy duty spuitpistool

Max
temperatuur:
90°C



3/4" BSP female - EPDM dichting

30550A3

3/4"

25

60

216.95

Nito I spuitpistool

Max
temperatuur:
60°C



1/2" insteeknippel - EPDM dichting

53800A1

1/2"

6

11

64.75

3/4" insteeknippel - EPDM dichting

63820A1

3/4"

6

11

64.75

Nito instelbare spuitkop



1/2" en 3/4" slangpilaar aansluiting

20000A4

15 en 20

22.75



3/4" BSP female aansluiting

20300A9

40.85

KELM™
pneumatiek

Hydrauliek

Snel-
koppelingen

Atsluiters

Roestvast
staal

Fittingen

Lucht-
conditionering

Gereedschap

Pneumatiek

Diversen

Malleabele
fittingen
& staal

Ringleiding-
systemen

Slangen

Compressoren



INGCO industrieel handgereedschap

**Ergonomisch
comfort,
gebruiksgemak en
duurzaamheid**

- Ergonomisch gevormd voor moeiteloze prestaties met slijtvast rubber voor een comfortabele grip.
- Onderworpen aan strenge kwaliteitstesten
- Uitzonderlijke kwaliteit voor een verassende prijs

Sleutels

- Cr-V staal
- Comfortabele tweecomponenten antislip handgreep



Verstelbare moersleutel

0455



HADW131068	6" (150mm) - 0-20mm	8.60
HADW131088	8" (200mm) - 0-30mm	11.95
HADW131108	10" (250mm) - 0-35mm	15.95
HADW131128	12" (300mm) - 0-40mm	25.50

- Cr-V staal, fijn gepolijst
- Maten: 6, 8, 10, 12, 14, 15, 17 en 19mm



Ring-steeksleutels - 8-delige set

0455



HKSPA1088	6-19mm	22.20
------------------	--------	--------------

- Cr-V staal
- Maten: 6, 8, 10, 12, 14, 17, 19, 22, 24, 27, 30 en 32mm
- Geleverd in oprolbare tas



Ring-steeksleutels - 12-delige set

0455



HKSPA1143	6-32mm	80.35
------------------	--------	--------------

- Cr-V staal
- Maten: 6 x 7mm, 8 x 9mm, 10 x 11mm, 12 x 13mm, 14 x 15mm, 16 x 17mm, 18 x 19mm en 20 x 22mm



Steeksleutels - 8-delige set

0455



HKSPA2082	6-22mm	25.55
------------------	--------	--------------

- Cr-V staal
- Maten: 8, 10, 12, 13, 14, 15, 17 en 18mm
- 60-72T



Ringratel-steeksleutels - 8-delige set

0455



HKSPAR1081	8-18mm	90.60
-------------------	--------	--------------

- Cr-V staal, fijn gepolijst
- Maten: 19, 22, 24, 27 30 en 32mm
- Geleverd in oprolbare tas
- 60-72T



Ringratel-steeksleutels - 6-delige set

0455



HKSPAR1061	19-32mm	133.65
-------------------	---------	---------------

- Cr-V staal, verchromd en matte finish



Individuele ring-steeksleutels

0455



HCSPA061	6mm	101	1.85
HCSPA071	7mm	111	1.90
HCSPA081	8mm	121	1.90
HCSPA091	9mm	131	2.15
HCSPA101	10mm	141	2.30
HCSPA111	11mm	152	2.40
HCSPA121	12mm	161	2.55
HCSPA131	13mm	172	2.80
HCSPA141	14mm	183	2.85
HCSPA151	15mm	191	3.30
HCSPA161	16mm	201	3.50
HCSPA171	17mm	211	3.60
HCSPA181	18mm	221	4.10
HCSPA191	19mm	231	4.15
HCSPA201	20mm	242	4.75
HCSPA211	21mm	253	4.95
HCSPA221	22mm	262	5.30
HCSPA241	24mm	287	7.25
HCSPA271	27mm	331	9.95
HCSPA301	30mm	384	12.30
HCSPA321	32mm	405	13.75
HCSPA361	36mm	460	21.85
HCSPA381	38mm	460	22.85
HCSPA411	41mm	500	26.20

- Cr-V staal, fijn gepolijst
- Maten: 6 x 7mm, 8 x 9mm, 10 x 11mm, 12 x 13mm, 14 x 15mm, 16 x 17mm, 18 x 19mm en 20 x 22mm



Offset ringsleutels - 8-delige set

0455



HKSPA3088	6-22mm	28.45
------------------	--------	--------------

Dopsleutels

- Cr-V staal - microfinish en verchroomd
- Inhoud:
Ratel 1/4" 72T met snelsluiting en soft-grip handgreep
Verlengstukken: 50mm en 100mm
Kniegewricht
Rechte zachte handgreep
Flexibel verlengstuk
Doppen: 4, 4.5, 5, 5.5, 6, 7, 8, 9, 10, 11, 12, 13 en 14mm
Schroefbits: PH1, PH2, PH3, PZ1, PZ2, PZ3, SL4, SL5, SL6, T10, T15, T20, T25 en T30 -
Zeskant 1.5, 2, 3, 4, 5 en 6mm
- Geleverd in duurzame kunststof draagkoffer



Bit/dopsleutelset 1/4" - 45-delige set

0455



HKTS14451

69.20

- Cr-V staal - microfinish en verchroomd
- Inhoud:
Ratel 1/2" 72T met snelsluiting en soft-grip handgreep
Verlengstukken: 125mm en 250mm
Kniegewricht
Doppen: 10, 11, 12, 13, 14, 15, 16, 17, 18, 19, 20, 21, 22, 23, 24, 27, 30 en 32mm
Bougiedoppen: 16mm en 21mm
- Geleverd in duurzame kunststof draagkoffer



Dopsleutelset 1/2" - 25-delige set

0455



HKTS12251

151.35

- Cr-V (50BV30) staal - thermisch gehard
- Inhoud:
Ratel 1/4" en 1/2" 45T
Verlengstukken 1/4": 50mm en 100mm
Verlengstukken 1/2": 125mm en 250mm
Kniegewricht 1/4" en 1/2"
Doppen 1/4": 4, 4.5, 5, 5.5, 6, 7, 8, 9, 10, 11, 12, 13 en 14mm
Doppen 1/2": 8, 10, 12, 13, 14, 15, 16, 17, 18, 19, 20, 21, 22, 23, 24, 27, 30 en 32mm
T-schuifgreep 1/4": 114mm
T-schuifgreep 1/2": 250mm
Flexibel verlengstuk 1/4": 150mm
Bougiedoppen: 16mm en 21mm
- Geleverd in duurzame kunststof draagkoffer



Dopsleutelset 1/4" & 1/2" - 44-delige set

0455



HKTS42441

141.25

- CR-V + Cr-Mo staal



Individuele dopsleutels

0455



HRTH0814 1/4" - 158mm lengte 10.15

HRTH0838 3/8" - 205mm lengte 13.70

HRTH0812 1/2" - 260mm lengte 18.50

Booraccessoires

- 6x metaalboren, maten: 2mm, 3mm, 4mm, 5mm, 6mm en 8mm
- 5x steenboren, maten: 4mm, 5mm, 6mm, 8mm en 10mm
- 5x houtboren, maten: 4mm, 5mm, 6mm, 8mm en 10mm



Diverse boren - 16-delige set

0455



AKD9165

15.80

- Maten: 5mm x 85mm, 6mm x 100mm, 6.5mm x 120mm, 8mm x 120mm en 10mm x 120mm



Steenboren - 5-delige set

0455



AKD3051

5-10mm

10.25

- Maten: 20, 33, 25, 29, 32, 35, 38, 44, 48 en 50mm
- 2-delige boorhouder



Bimetalen gatzagen - 12-delige set

0455



AKH0121

20-50mm

103.40

- S2 gereedschapstaal
- Schroefbits: PH1, PH2, PH3, SL4.0, SL5.5, SL6.5, PZ1 en PZ2
- Magnetisch



Schroefbits - 9-delige set

0455



AKSD0071

5.50

Tangen & scharen

- Cr-V staal met zwarte finish
- Heavy duty constructie
- Diagonale snijkanten
- Comfortabele TPR antislip handgreep



Heavy duty zijknijptang

0455



HHDCP28180 7" (180mm) **9.40**

- Cr-V staal met zwarte finish
- Diagonale snijkanten
- Comfortabele TPR antislip handgreep



Zijknijptang

0455



HDCCP28180 7" (180mm) **9.05**

- Cr-V staal met zwarte finish
- Comfortabele TPR antislip handgreep



Combinatietang

0455



HCP28160 6" (150mm) **8.25**
HCP28200 8" (200mm) **10.25**

- Cr-V staal met zwarte finish
- Comfortabele TPR antislip handgreep



Gebogen punttang

0455



HBNP28160 6" (150mm) **7.80**

- Cr-V staal met zwarte finish
- Comfortabele TPR antislip handgreep



Lange punttang

0455



HLNP28160 6" (150mm) **7.40**

- Cr-V staal met zwarte finish
- Comfortabele TPR antislip handgreep
- Inhoud:
6" (150mm) zijknijptang
6" (150mm) lange punttang
8" (200mm) combinatietang



Tangen - 3-delige set

0455



HKPS2831 **27.65**

- Cr-V staal met zwarte finish
- Hefboomwerking, 30% minder krachtinspanning
- Comfortabele TPR antislip handgreep



Combinatietang - hefboomwerking

0455



HHCP28200 8" (200mm) **11.00**

- Cr-V staal met zwarte finish
- Hefboomwerking, 30% minder krachtinspanning
- Comfortabele TPR antislip handgreep



Zijknijptang - hefboomwerking

0455



HHLDCP28180 7" (180mm) **9.60**

- Cr-V staal met zwarte finish
- Hefboomwerking, 30% minder krachtinspanning
- Comfortabele TPR antislip handgreep



Lange punttang - hefboomwerking

0455



HHLNP28160 6" (150mm) **8.10**

Tangen & scharen

- Cr-V staal met zwarte finish
- Slijtvaste TPR handgreep



Kopkniptang

0455



HECP02180

7" (180mm)

9.20

- Cr-V staal met zwarte finish
- Diagonale snijkanten
- Slijtvaste TPR handgreep



Verstelbare moerentang

0455



HSPJP02200

8" (200mm)

5.75

- Cr-V staal met zwarte finish
- Comfortabele TPR antislip handgreep



Waterpomptang

0455



HPP28250

10" (250mm)

10.80

- Cr-V staal HRC52-HRC60 - thermisch gehard en vernikkeld
- Kunststof greep



Griptang met rechte bekken

0455



HSJP02210

8" (200mm)

11.55

- Cr-V staal HRC52-HRC60 - thermisch gehard en vernikkeld



Griptang met lange bekken

0455



HLNP0109

8" (200mm)

8.60

- Cr-V staal
- Maximale bek-opening 50mm



Griptang met gebogen bekken

0455



HCJLW0110

10" (250mm)

14.10

- Cr-V staal
- Kettinglengte 18.5" (470mm)



Griptang met ketting

0455



HCLP0110

10" (250mm)

24.00

- Koolstofstaal met zwarte finish



Kabelsnijtang - heavy duty

0455



HHCCB0210

10" (250mm)

8.60

- Cr-Mo staal bekken
- Snijgebied: 240mm²
- Geschikt voor het snijden van koper en aluminium kabel
- Niet geschikt voor ACSR, staaldraad of staal



Kabelsnijtang

0455



HCCB20124

24" (600mm)

27.05

Tangen & scharen

- Cr-V staal bekken met zwarte finish



Betonschaar

0455		€
HBC0824	24" (600mm)	33.50

- Cr-Mo staal bekken
- Recht blad voor links- en rechtshandig gebruik
- Comfortabele TPR antislip handgreep



Aviation bliksschaar

0455		€
HTSN0210S	10"	15.00

- Hoge kwaliteit gesmeed koolstofstaal



Pijptang

0455		€
HPW0308	8" (200mm) - max. diameter 27mm	7.40
HPW0812	12" (300mm) - max. diameter 42mm	12.65
HPW0818	18" (450mm) - max. diameter 60mm	22.20
HPW0824	24" (600mm) - max. diameter 76mm	30.70
HPW0836	36" (900mm) - max. diameter 85mm	59.70
HPW0848	48" (1200mm) - max. diameter 110mm	78.80

- Koolstofstaal met zwarte finish



Pijptang met ratelfunctie

0455		€
HPW1410	10" (250mm) - diameter 14-40mm	20.20
HPW1414	14" (350mm) - diameter 15-52mm	31.80

Gereedschapset

- Inhoud
1/4" en 1/2" ratel 45T
Doppen 1/4": 4, 4.5, 5, 5.5, 6, 7, 8, 9, 10, 11, 12, 13 en 14mm
Doppen 1/2": 10, 11, 12, 13, 14, 15, 16, 17, 18, 19, 20, 21, 22, 23, 24, 27, 30 en 32mm
Verlengstuk 1/4": 100mm
Verlengstuk 1/2": 250mm
Kniegewricht 1/4" en 1/2"
Bougiedoppen 1/2"
Drieweg adapter 1/2" x 3/8"
T-schuifgreep 1/4"
Ring-steeksleutels: 6, 8, 10, 12, 14, 15, 17, 19mm
Bankhamer 300 gram
7" combinatietang
6" lange punttang
- Schroevendraaiers:
SL6.5 x 100mm en
PH2 x 100mm
Schroefbits: T10, T15, T20, T25, T27, T30, T35, SL4, SL5.5, SL6.5, PH1, PH2, PZ1 en PZ2
Inbussleutels: 1.5, 2, 2.5, 3, 4, 5, 6, 8 en 10mm
- Geleverd in duurzame kunststof draagkoffer



77-delige set

0455		€
HKTHP20771		203.35

- Cr-V staal
- Inhoud:
7" combinatietang
6" zijknijptang
8" verstelbare moersleutel
3m x 16mm rolmaat
100mm magnetische bitschroevendraaier
Schroefbits: SL3, SL4, SL5, SL6, PH0, PH1, PH2, PH3, PZ0, PZ1, PZ2, PZ3, T10, T15, T20, T30, H3, H4, H5 en H6
- Geleverd in stevige kunststof draagkoffer



25-delige set

0455		€
HKTH10258		53.25

Schroevendraaiers

- Cr-V staal
- Ergonomische soft-grip handgreep
- Ronde schacht
- Magnetisch

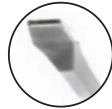

Platte kop schroevendraaier

0455



HS283075	3.0mm	75mm	1.15
HS284100	4.0mm	100mm	1.50
HS285100	5.5mm	100mm	1.70
HS282038	6.5mm	38mm	2.10
HS286125	6.5mm	125mm	2.40
HS286150	6.5mm	150mm	2.45
HS288200	8.0mm	200mm	3.85



Phillips kruiskopschroevendraaier

0455



HS28PH0075	PH0	75mm	1.15
HS28PH1100	PH1	100mm	1.70
HS28PH2038	PH2	38mm	1.75
HS28PH2150	PH2	150mm	2.45
HS28PH3200	PH3	200mm	3.85



Pozidriv kruiskopschroevendraaier

0455



HS28PZ1100	PZ1	100mm	1.70
HS28PZ2150	PZ2	150mm	2.45

- Cr-V staal
- Comfort-grip handgreep
- **Maten:**
SL2 x 50mm,
SL2.5 x 50mm,
SL3 x 50mm,
PH00 x 50mm,
PH0 x 50mm,
T6 x 50mm
en T8 x 50mm
- Geleverd met kunststof opbergdoos



Precisie schroevendraaiers - 7-delige set

0455



HKSD0718 10.00

- Cr-V staal
- Ergonomische soft-grip handgreep
- Ronde schacht
- **Maten:**
SL3 x 75mm,
SL5 x 100mm,
SL6.5 x 150mm,
SL6.5 x 38mm,
PH0 x 75mm,
PH1 x 75mm,
PH2 x 125mm
en PH2 x 38mm



Schroevendraaiers - 8-delige set

0455



HKSD0828 15.80

- Cr-V staal
- Ergonomische soft-grip handgreep
- Ronde schacht

- **Maten standaard:**
SL5.5 x 75mm,
SL6.5 x 100mm,
SL8 x 150mm,
SL6.5 x 38mm,
PH1 x 75mm,
PH2 x 100mm,
PH3 x 150mm
en PH2 x 38mm

- **Maten precisie:**
SL1.5 x 50mm,
SL2 x 50mm,
SL2.5 x 50mm,
SL3 x 50mm,
PH000 x 50mm,
PH00 x 50mm,
PH0 x 50mm,
T6 x 50mm,
T8 x 50mm
en T10 x 50mm



(Precisie) schroevendraaiers - 18-delige set

0455



HKSD1828 29.05

- S2 gereedschapstaal
- Zeskantschacht



Go-thru platte kop schroevendraaier

0455



HGTS286100	6mm	100	4.10
HGTS288150	8mm	150	6.35

- S2 gereedschapstaal
- Zeskantschacht



Go-thru Phillips kruiskopschroevendraaier

0455



HGTS28PH3150	PH3	150	6.35
HGTS28PH2100	PH2	100	4.10

Schroevendraaiers

- Inhoud:
Flexibele schroevendraaier en adapter 4-6mm
Schroefbits (6.35x25mm) : SL5, SL6, SL7, PH1, PH2, PH3, T10, T15, T20 en T25



Flexibele schroevendraaier - 12-delige set

0455



AKSDFL1208

6.70

- Cr-V staal
- Inhoud:
INGCO stijl T-greep ratel en adapter 4-6mm
Magnetische bithouder 5mm (100mm)
Schroefbits (6.35x25mm): SL4, SL5, SL6, PH1, PH2, PH3, PZ1, PZ2 en PZ3,
Doppen 1/4": 5, 6, 7, 8, 9 en 10mm



T-greep ratelschroevendraaier - 18-delige set

0455



HKSDB0188

9.60

- Cr-V staal
- Inhoud:
Industriële ratel
Schroefbits: H1, PH2, PH3, PZ1, PZ2 en PZ3
Doppen: 5, 6, 8, 10 en 12mm



Ratelschroevendraaier 15-in-1

0455



AKISD1501

16.80

- Cr-V staal
- Inhoud:
Industriële ratel en adapter 4-6mm
Bithouder: 125mm en 75mm
Schroefbits: SL3, SL4, SL5, SL6, SL7, PH0, PH1, PH1, PH2, PH2, PH3, PH3, PZ1, PZ2, PZ3, T15, T20, T30, S1, S1, S2, S2, S3
Doppen: 4, 5, 6, 7, 8, 9, 10, 11, 12 en 13mm
- Geleverd in kunststof opbergdoos



Ratelschroevendraaier - 38-delige set

0455



HKSDB0381

27.10

Hamers

- Gesmede hamerkop
- Thermisch gehard koolstofstaal
- Glasvezel handgreep



Bankhamer

0455



HMH080500

500 gram

7.40

- Glasvezel handgreep



Rubberen hamer

0455



HRUH8208

220 gram

5.20

- Glasvezel handgreep



Kunststof en rubberen combihamer

0455



HRPH8140

40mm kop

12.45

- Geheel gehard staal, gesmeed
- Anti-shock greep



Klauwhamer - geheel staal

0455



HCH0820

560 gram

23.50

Hamers

- Gesmede hamerkop
- Thermisch gehard koolstofstaal
- Glasvezel handgreep



Zeer sterk

Stevige grip

Glasvezel

PP

TPR

Bolbankhamer



HBP08032

900 gram

9.40

- Gesmede hamerkop
- Thermisch gehard koolstofstaal
- Glasvezel handgreep



Klauwhamer



HCH0816

450 gram

9.50

- Gesmede hamerkop
- Thermisch gehard koolstofstaal
- Glasvezel handgreep



Vuisthamer



HSTH0804

2000 gram

18.25

- Thermisch gehard koolstofstaal, gesmeed
- Glasvezel handgreep



Moker - lengte 900mm



HSM01598

5400 gram

49.85

Beitels

- Cr-V staal
- Kop: 6, 12, 19 en 25mm
- Lengte 140mm



Houtbeitels - 4-delige set



HKTWC0401

23.10

- Handgreep 19mm
- Lengte 215mm



Voegbeitel



HCCL837610

76mm kop

23.55

- Handgreep 19mm
- Lengte 305mm



Koudbeitel



HCCL812512

25mm kop

21.00

- Handgreep 19mm
- Lengte 215mm



Steenbeitel



HCCL844410

44mm kop

16.10

- Handgreep 19mm
- Lengte 305mm



Betonpuntbeitel



HCC8141219

4mm kop

18.75

Vijlen

- T12 staal
- Inhoud:
 - Platte vijl
 - Ronde vijl
 - Halfronde vijl
- Geleverd in kunststof blisterverpakking



3-delige set

0455



HKTFS1308 8" (200mm) **17.75**

- T12 staal
- Inhoud:
 - Platte vijl
 - Ronde vijl
 - Halfronde vijl
 - Driehoekige vijl
 - Blokvijl



5-delige set

0455



HKTFS0508 8" (200mm) **28.45**

Inbussleutels

- Cr-V staal, thermisch gehard en verchroomd
- Geleverd met kunststof houder



Metrisch - 9-delige set

0455



HHK11092 1.5-10mm **10.85**

- Cr-V staal, thermisch gehard en verchroomd



Metrisch - 8-delig zakmesmodel

0455



HHK14081 2-8mm **8.10**

- Cr-V staal, thermisch gehard en verchroomd
- Geleverd met kunststof houder



Metrisch met kogelkop - 9-delige set

0455



HHK12091 1.5-10mm **9.05**

- Cr-V staal, thermisch gehard en verchroomd
- Maten:
 - 2mm x 75mm,
 - 2.5mm x 75mm,
 - 3mm x 100mm,
 - 4mm x 100mm,
 - 5mm x 150mm,
 - 6mm x 150mm,
 - 8mm x 200mm
 - en 10mm x 200mm
- Geleverd in kunststof blisterverpakking



Metrisch met T-greep - 8-delige set

0455

Maat



HHKT0082 2-10mm **23.15**

- Cr-V staal, thermisch gehard en verchroomd

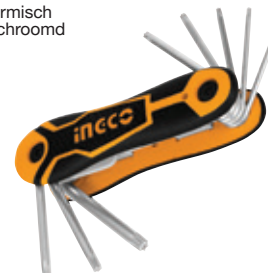

Torx - 8-delig zakmesmodel

0455



HHK14083 T9 - T40 **7.45**

- Cr-V staal, thermisch gehard en verchroomd
- Geleverd met kunststof houder



Torx - 9-delige set

0455



HHK13091 T10 - T50 **8.95**

Zagen

- Verstelbaar
- 1 zaagblad met bladbescherming
- Soft-grip handgreep



Verstelbare beugelzaag

0455



HHF3008

12" (300mm)

15.20

- 1 zaagblad met bladbescherming
- Kunststof handgreep



Standaard beugelzaag

0455



HHF3018

12" (300mm)

5.35

- M2 + D6A bimetaal
- Geleverd per stuk

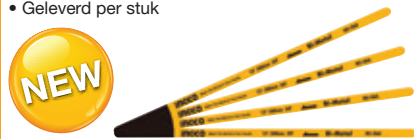

Bimetalen zaagbladen

0455



HSBB12182

12" (300mm) - 18 TPI

1.85

HSBB12242

12" (300mm) - 24 TPI

1.85

- Zaagblad met bladbescherming
- Thermisch gehard



Handzaag

0455



HHAS08550

550mm - 7 TPI

8.70

Snijgereedschap

- Hoge kwaliteit snijmes
- Aluminium knop



Pijpsnijder - voor koper en aluminium buizen

0455



HPC0232

3-32mm

9.75



Pijpsnijder met ratelfunctie - voor PVC

0455



HPC0442

3-42mm - 225mm lengte

15.95

- Aluminium behuizing



Pijpsnijder - voor PVC

0455



HPC0535

3-35mm - 210mm lengte

7.80

- 5 reservemesjes
- Automatische vergrendeling
- Totale lengte 169mm



Afbreekmes

0455



HKNS1805

Mes: 18mm x 100mm

4.45

- 5 reservemesjes
- Aluminium handgreep



Vast vouwmes

0455



HUK613

Mes: 19mm x 61mm

9.40

Meetgereedschap

- Breedte 25mm
- Zelfvergrendeling
- Volledig rubber behuizing



Rolmaat

0455



HSMT0808

8 meter

8.65

- 12,5mm breedte
- Geleverd in displaydoos



Fiber landmeter

0455



HFMT02100

100 meter

33.65

- Aflezing: 0.01mm
- Hoogwaardige stalen behuizing
- Geleverd in kunststof opbergcassette



Schuifmaat

0455



HDCD01150

0-150mm

41.25

Klemmen

- Gietijzer



G-klem

0455



HGC0104

4"

8.90

Waterpassen

- Gefreesd werkoppervlak
- Meetnauwkeurigheid 0,5mm/m
- Aluminium dikte 1,5mm
- V-groef voor gebruik op ronde oppervlakken
- Geleverd met displayhoes



Aluminium

0455



HSL08030

30cm lengte

10.00

HSL08060

60cm lengte

16.65

HSL08100

100cm lengte

23.55

HSL08150

150cm lengte

32.85

HSL08200

200cm lengte

42.30

Gereedschapskist

- Afmeting 95 x 200 x 290mm
- 3 lagen - 5 compartimenten
- Staaldikte 0.6-0.8mm
- Netto gewicht 5,5 kg



Staal - 5 compartimenten

0455



HTB02

495 x 200 x 290mm

81.80

Zaklantaarns

- Materiaal behuizing: luchtvaart aluminium
- 100.000 uur levensduur
- Werkt op 3 x AAA batterijen (niet meegeleverd)
- 5 uur gebruiksduur
- IPX-4 IP-classificatie
- Diameter 32mm
- Lengte 126.5mm
- Gewicht 105 gram



Aluminium - 200 meter lichtbereik

0455



HFL013AAA1

135 lumen

24.30

- Materiaal behuizing: luchtvaart aluminium
- 100.000 uur levensduur
- Werkt op 3 x D-batterijen (niet meegeleverd)
- 45 uur gebruiksduur
- IPX-4 IP-classificatie
- Diameter 57.5mm
- Lengte 327.7mm
- Gewicht 395 gram



Aluminium - 270 meter lichtbereik

0455



HFL013D1

250 lumen

51.00

Multitool

- Sterke aluminium handgreep
- Lengte: 95mm
- Funcities:**
- Groot mes
- Blikopener
- Phillips kruiskopschroevendraaier
- Platte kop schroevendraaier
- Priem
- Flessenopener
- Schaar
- Naald
- Schubmes
- Haakverwijderaer
- Zaag
- Kurkentrekker
- Nagelreiniger
- Nagelvijl
- Sleutelring



15 functies

0455



HMF0118

10.50

Handschoenen

- One size (XL)
- Met palmcoating
- Nitril coating - EN388 4121 gekeurd
- Latex coating - EN388 3142 gekeurd



Maat XL

0455



HGNG01

Nitril palmcoating

1.40

HGVL03

Latex palmcoating

2.80

Spuiten

- Voor gebruik met 400cc cartridges
- Materiaal: 1.2mm stalen buis en gegoten aluminium
- 12" (300mm) hogedruk flexibele nylon slang
- Metalen gebogen tuit
- Geleverd in displaydoos



Schaarvetspuit

0455



GRG015001

23.15

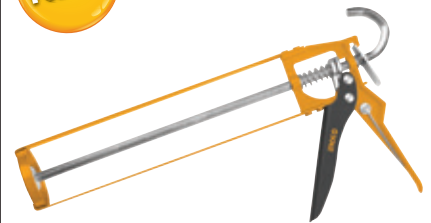

Kitspuit

0455



HCG1409

9"

5.35

Betaalbare kwaliteit door grootschalige productie en efficiëntie met als resultaat de best mogelijke prijs / kwaliteit verhouding.

Gerolde metaalborenset

Inhoud set:
1 x 1-10mm
(elke 0,5mm)



19-delig - HSS DIN 334 -
in metalen cassette

DRIL

1900019

€

7.40

Geslepen metaalborenset

Inhoud set:
1 x 1-10mm
(elke 0,5mm)



19-delig - HSS DIN 338RN splitpoint -
in metalen cassette

DRIL

1900029

€

23.00

Houtspeedborenset

Inhoud set:
6, 8, 10, 12, 13, 14, 16, 17, 18, 19, 20, 22, 25mm



13-delig - zeskant opname -
in een houten kist

DRIL

14291513

€

10.05

Metaalverzinkborenset

Inhoud set:
6,3mm, 8,3mm, 12,4mm,
16,5mm & 20,5mm



6-delig - HSS - zeskant opname -
in metalen cassette

DRIL

C119-006S

€

29.90

Universele borenset

Voor gebruik met o.a.kunststof, keramiek, steen,
beton, hout, glas en metaal.

Inhoud set:
4, 5, 6 en 8mm



Met hardmetalen plaat - geschikt
voor gebruik in alle materiaalsoorten -
in kunststof cassette

DRIL

190004

€

5.40

KELM™
pneumatiek

Hydrauliek

Snel-
koppelingen

Atsluiters

Roestvast
staal

Fittingen

Lucht-
conditionering

Gereedschap

Pneumatiek

Diversen

Malleabele
fittingen
& staal

Ringleiding-
systemen

Slangen

Compressoren

Slang & schroefdraad selectie

Slang O.D. maatwijzer

Plaats de slang op de cirkels om de buitenmaat vast te stellen

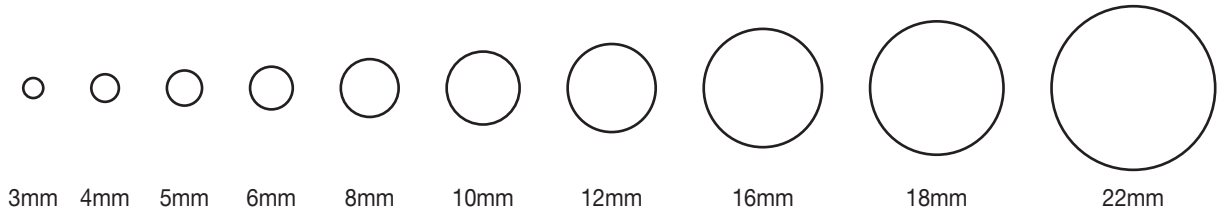

BSPT schroefdraad maatwijzer

Plaats de fitting op de afbeeldingen om de schroefdraadmaat vast te stellen





MENS, MAATWERK & TECHNIEK

Professionals in Flow & Fluid Technology

Gewoon

www.aimfluid.nl



Neutrale medium



Agressieve medium



Heet water

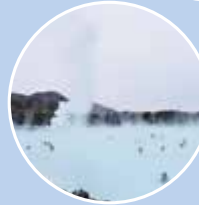

Stoom



Pneumatiek

| AIM FLUID CONTROL |

Het meten en regelen van Flow & Fluid Technology is onze 2^e natuur



aim *fluid control* sinds 1995. Als onafhankelijke specialist in het meten en regelen van diverse soorten vloeistof- en gasstromen (Flow & Fluid Technology) richt aim zich op de professionele markt. De markt met de behoefte aan standaardproducten tot aan engineeringprojecten die verregaande technische kennis vereisen op het gebied van afsluiters, magneetventielen, pneumatiek ventielen, actuators, appendages, vacuümpompen, compressoren, fittingen en toebehoren.

Vanuit het hoofdkantoor en magazijn te Son & Breugel, nabij Science Park Ekkersrijt, ontzorgt aim zijn klanten van A tot Z en biedt technische en logistieke maatwerkoplossingen middels gedegen kennis, een gedreven en persoonlijke service én een klantspecifiek voorraadbeheer.

Ontzorgend, **Betrokken** & **Verantwoordelijk**

aim fluid control b.v.
Ekkersrijt 7310-7312
5692 HH Son en Breugel / Nederland
T. +31(0) 499 49 10 90
E. info@aimfluid.nl
F. +31(0) 499 49 63 70
I. www.aimfluid.nl

