

MH 531 101  
MH 531 121  
MH 531 181  
MH 531 121 NPT

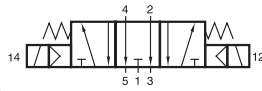

MH 532 101  
MH 532 121  
MH 532 181  
MH 532 121 NPT

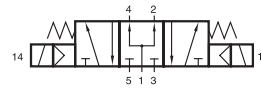

MH 533 101  
MH 533 121  
MH 533 181  
MH 533 121 NPT

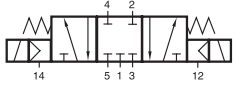

MEH 531 101  
MEH 531 121  
MEH 531 181

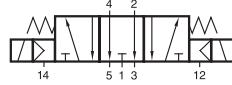

MEH 532 101  
MEH 532 121  
MEH 532 181

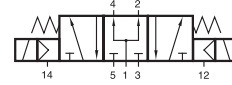

MEH 533 101  
MEH 533 121  
MEH 533 181

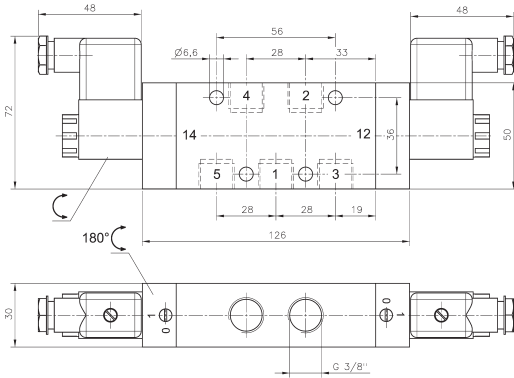

MH 53\_101

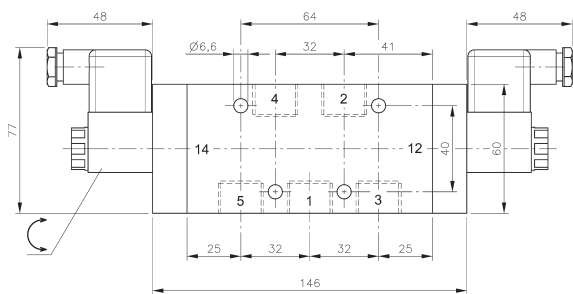

MH 53\_121/MH 53\_121 NPT

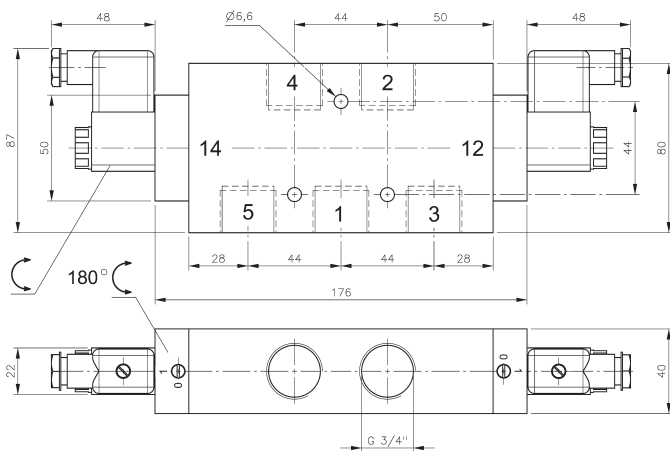

MH 53\_181

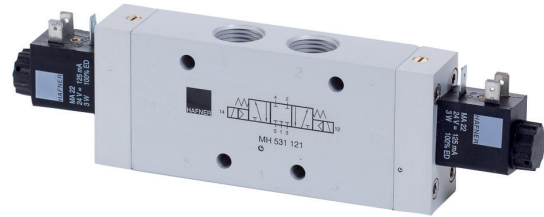

5/3-way solenoid valve with spring return to middle position, actuated by permanent signal.

- Type 531 centre closed
- Type 532 centre exhausted
- Type 533 centre pressurised

When ordering please complete the type number by 1, 2 or 3 according to the type required.

Available with solenoid operators:  
230V/50Hz, 110V/50Hz, 24V/50Hz, 48V=,  
24V=, 12V=.

Valves are generally equipped with manual override.  
If requested without manual override please order  
M 53\_ \_ \_ \_.

Valves are also available with external pilot feed.  
Type: MEH 53\_ \_ \_ \_ (please add 1 digit for type  
and 3 digits for size).

Ports 12 and 14: G 1/8".

Minimum actuation pressure: 3 bar.

Operating pressure: 0-10 bar.

Version for vacuum on request.

| Type           | Port size | Air flow   | Operating press. | Power consumption | Weight  |
|----------------|-----------|------------|------------------|-------------------|---------|
| MH 53_ 101     | G 3/8"    | 2250 l/min | 1,5 - 10 bar     | 3 W = / 5 VA ~    | 0,66 kg |
| MH 53_ 121     | G 1/2"    | 3000 l/min | 1 - 10 bar       | 3 W = / 5 VA ~    | 0,84 kg |
| MH 53_ 181     | G 3/4"    | 6000 l/min | 1 - 10 bar       | 3 W = / 5 VA ~    | 1,45 kg |
| MH 53_ 121 NPT | 1/2" NPT  | 3000 l/min | 1 - 10 bar       | 3 W = / 5 VA ~    | 0,84 kg |

