

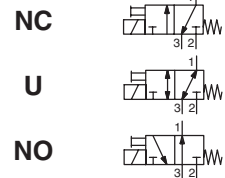

SOLENOID VALVES

direct operated
1/8 - 1/4



3/2
Series
356

FEATURES

- Compact design for the control of single-acting actuators or filling and draining cycles
- Wide range of flow and pressure ratings
- Quick disassembly of core tube for easy maintenance of internal parts
- Standard disc seal made of FPM suitable for a wide range of operating temperatures and compatible with many fluids
- Standard manual operator allows an easy installation
- AC/DC interchangeability of the solenoid without disassembly of the valve
- Compliance with UL and CSA standards (coil 4/6,9 W)
- Compact and low weight valve
- The solenoid valves satisfy all relevant EC directives

GENERAL

Differential pressure See «SPECIFICATIONS» [1 bar =100 kPa]
Maximum viscosity 40 cSt (mm²/s)
Response time 5 - 10 ms

fluids (*)	temperature range (TS)	seal materials (*)
air, inert gas, water, oil	-10°C to +100°C	FPM (fluoroelastomer)

MATERIALS IN CONTACT WITH FLUID

(*) Ensure that the compatibility of the fluids in contact with the materials is verified

	Brass body	Stainless steel body
Body	Brass	AISI 316
Core tube	Stainless steel	Stainless steel
Core and plugnut	Stainless steel	Stainless steel
Springs	Stainless steel	Stainless steel
Seat	Brass	Stainless steel
Seals	FPM	FPM
Disc	FPM	FPM
Shading coil	Copper	Copper

ELECTRICAL CHARACTERISTICS

Coil insulation class F
Connector Spade plug (cable Ø 6-8 mm or Ø 6-10 mm)
Connector specification DIN 43650, 11 mm, industry standard B (type 01) or ISO 4400 / EN 175301-803, form A (type 02) IEC 335
Electrical safety Moulded IP65 (EN 60529)
Electrical enclosure protection DC (=) : 24V - 48V
Standard voltages AC (~) : 24V - 48V - 115V - 230V / 50 Hz
 (Other voltages and 60 Hz on request)

prefix option	power ratings				operator ambient temperature range (TS) (C°)	replacement coil		type ⁽¹⁾
	inrush ~		holding ~			~	=	
	(VA)	(VA)	(W)	(W)		230 V/50 Hz	24 V DC	
SC	12	6	4	5 / 6,9	-10 to +60	400127-197	400127-142	01
	15	7	5	4 / 5	-10 to +60	400727-117	400727-185	02

⁽¹⁾ Refer to the dimensional drawings on the following page.

SPECIFICATIONS

pipe size	orifice size	flow coefficient Kv				operating pressure differential (bar)				power coil (W)		catalogue number		options		
		2→1		3→1		min.	max. (PS)		~	=	brass	stainless steel	EPDM			
		(m ³ /h)	(l/min)	(m ³ /h)	(l/min)		air, water, oil (*)	=								
G	(mm)	(m ³ /h)	(l/min)	(m ³ /h)	(l/min)		~	=	~	=	~/=	~/=				
NC - Normally closed																
1/8 ⁽²⁾	1,2	0,05	0,8	0,05	0,8	0	15	15	4	6,9	SCG356B001VMS	SCG356B013VMS	E	-	-	
	1,6	0,08	1,33	0,05	0,8	0	10	10	4	6,9	SCG356B002VMS	SCG356B014VMS	E	-	-	
	2,0	0,1	1,66	0,05	0,8	0	5	5	4	6,9	SCG356B003VMS	SCG356B015VMS	E	-	-	
	2,4	0,13	2,1	0,05	0,8	0	4	4	4	6,9	SCG356B004VMS	SCG356B016VMS	E	-	-	
1/4 ⁽²⁾	1,6	0,08	1,33	0,05	0,8	0	10	10	5	5	SCG356B466VMS	SCG356B434VMS	-	-	-	
	2,4	0,16	2,67	0,05	0,8	0	4	4	5	5	SCG356B470VMS	SCG356B436VMS	-	-	-	
U - Universal																
1/8 ⁽²⁾	1,6	0,06	1	0,05	0,8	0	4,5	4,5	4	6,9	SCG356B010VMS	SCG356B022VMS	E	-	-	
	2,0	0,08	1,33	0,05	0,8	0	3	3	4	6,9	SCG356B011VMS	SCG356B023VMS	E	-	-	
	2,4	0,09	1,5	0,05	0,8	0	2	2	4	6,9	SCG356B012VMS	SCG356B024VMS	E	-	-	
NO - Normally open																
1/8 ⁽²⁾	1,6	0,096	1,6	0,05	0,8	0	8,5	8,5	4	6,9	SCG356B006VMS	SCG356B018VMS	E	-	-	

⁽²⁾ Pipe size port 3: M5 (Orifice size = 1,2 mm).

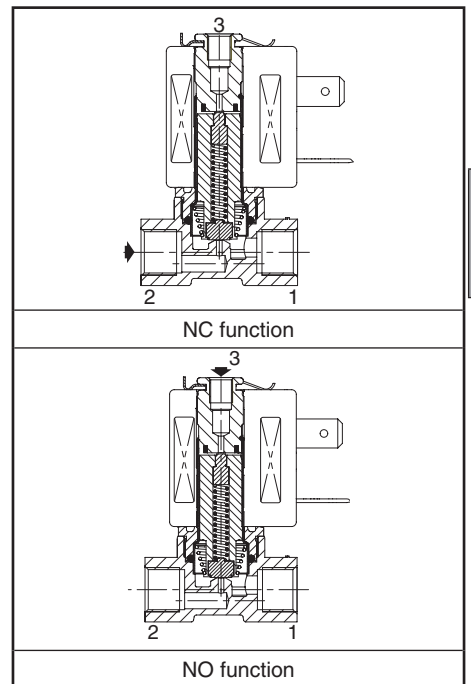

E

OPTIONS

- Valves can also be supplied with EPDM (ethylene-propylene) seals and discs. Use the appropriate optional suffix letter for identification (1/8 version only)
- Explosionproof enclosures for use in zones 1/21-2/22, categories 2-3 to ATEX Directive 94/9/EC (see "Explosionproof solenoids" section)
- Flying leads coil, use prefix L (e.g.: LG356B001VMS) (4 W/6,9 W coil only)
- Oxygen service with seals and disc in FPM, suffix NV, example: SCG356B001NVMS
- Solenoid valves integrated on manifold, orifice sizes 1,2 - 1,6 - 2 - 2,4 mm (See V591)
- French sanitary conformity approval ACS for potable water applications, suffix: FW (1/8 NC only)
- Without manual operator, on request
- Other pipe connections are available on request
- Plug with visual indication and peak voltage suppression or with cable length of 2 m (see Solenoids, Coils & Accessories section)

INSTALLATION

- The solenoid valves can be mounted in any position without affecting operation
- Solenoid valves have 2 mounting holes in body
- Pipe connection identifier is G = G (ISO 228/1)
- Installation/maintenance instructions are included with each valve

ORDERING EXAMPLES:

SC	G	356	B 001	VMS	230V / 50 Hz
SC	G	356	B 002	EMS	115V / 50 Hz
SC	G	356	B 014	NVMS	24V / DC
SC	G	356	B 001	FWMS	24V / DC
SC	G	356	B 456	VMS	230V / 50 Hz
SC	G	356	B 006	VMS	230V / 50 Hz

prefix — SC
 pipe thread — G
 basic number — 356
 B — basic number
 suffix — VMS, EMS, NVMS, FWMS
 voltage — 230V / 50 Hz, 115V / 50 Hz, 24V / DC

DIMENSIONS (mm), WEIGHT (kg)



TYPE 01

Prefix "SC" Solenoid
Epoxy moulded
IEC 335 / DIN 43650
IP65

NC/NO/U (1/8): All 1/8 catalogue numbers



TYPE 02

Prefix "SC" Solenoid
Epoxy moulded
IEC 335 / ISO 4400
IP65

NC (1/4): SCG356B434VMS/436VMS/466VMS/470VMS/471V/472V

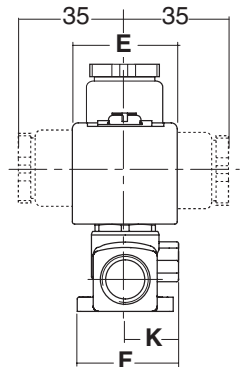
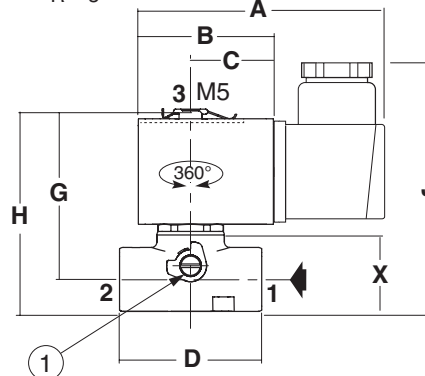
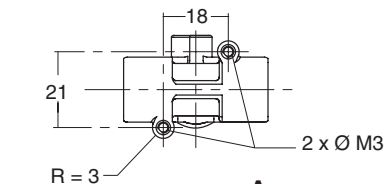
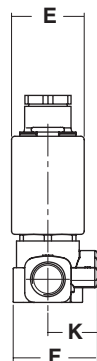
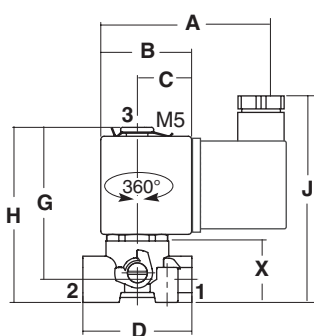
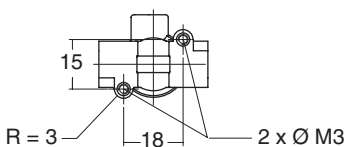

type	prefix option	pipe size	A	B	C	D	E	F	G	H	J	K	X	weight ⁽¹⁾	
														brass	stainless steel
01	SC	1/8	60,5	27,5	16,5	33	22	25,5	46	53	69	15	18,6	0,156	0,138
02	SC	1/4	76	38	23,3	40	29,7	28,5	48	57	79	15	23,4	0,232	0,229

⁽¹⁾ including coil and connector.