



PAV20

Robuust, pneumatisch bediend 2-weg RVS axiaal ventiel.
in dubbelwerkende en enkelwerkende uitvoering.

DOORLAAT

DN10 (3/8") tot DN50 (2")

AANSLUITING

- 2-Zijdig Binnendraad volgens UNI EN 10226 (DIN ISO 7/1)
- Opbouwflens volgens NAMUR.

DOORSTROMINGSRICHTING

Zie symbool.

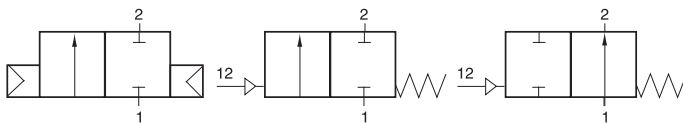

BEDRIJFSDRUK

PN16

Vacuum dicht 740 mm Hg

TEMPERATUUR BEREIK

- Van - 20° tot 80° (NBR)
- Van - 20° tot 150° (FPM) standaard
- Van - 20° tot 150° (EPDM)

MATERIALEN

Huis: RVS CF8M

Zuiger: RVS

Afdichting: EPDM, FPM, NBR

Veer: RVS (enkelwerkende uitvoering)

MONTAGE

Raadpleeg aanbeveling voor inbouw industriële afsluiters.

MEDIUM

Neutrale gassen en vloeistoffen. Voor toepassingen met agressieve media bestendigheidstabel raadplegen.

BEDIENING (Standaard)

Lucht

dubbelwerkende of enkelwerkende (Veer sluitend "NC" of veer openend "NO") uitvoering.

STUURMEDIUM

Gefilterde lucht volgens PNEUROP/ISO klasse 4, ander stuurmedia op aanvraag

STUURDRUK

- 3 bar min. - 8 bar maximaal bij dubbelwerkende uitvoering.
- 4,3 bar min. - 8 bar maximaal bij enkelwerkende uitvoering.

PNEUMATISCHE AANSTUURING

Optioneel naar gelang uitvoering met een 3/2, 5/2-weg magneetventiel met NAMUR-aansluiting

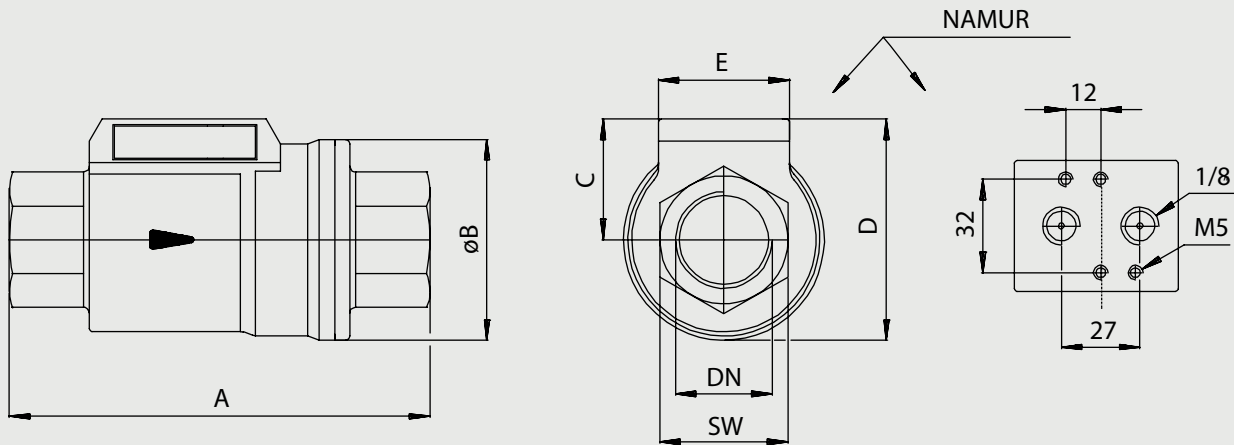

Gesloten afsluiter

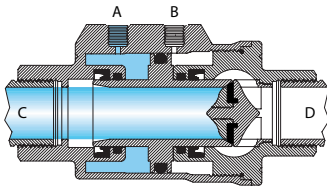

Tussen fase afsluiter

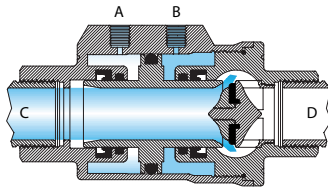

Geopende afsluiter

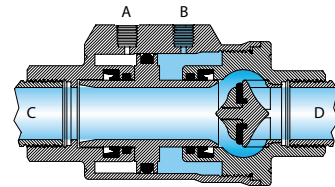

Dubbelwerkend axiaalventiel met gasdraad, FPM

Doorlaat[mm] aansluiting[mm]		max. druk [bar] PN	Stuur- druk	Flens	Functie	Kv	Inbouwmaat [mm] en gewicht [kg]						Bestelcode	
DN	Rp						A	B	C	D	SW	E		Gewicht
10	3/8	16	3-8	NAMUR	DW	6,9	98	46	31	54	22	45	0,80	3PAV20200010
15	1/2	16	3-8	NAMUR	DW	8,8	112	52	33	59	26,5	45	1,00	3PAV20200015
20	3/4	16	3-8	NAMUR	DW	11,4	135	64	38	70	32	45	1,50	3PAV20200020
25	1	16	3-8	NAMUR	DW	14,5	143	69	41	76	41	45	1,92	3PAV20200025
32	1.1/4	16	3-8	NAMUR	DW	27,9	165	86	49	92	50	45	3,06	3PAV20200030
40	1.1/2	16	3-8	NAMUR	DW	48,8	180	96	54	102	56	45	3,76	3PAV20200035
50	2	16	3-8	NAMUR	DW	68,9	207	108	60	114	70	45	4,71	3PAV20200040

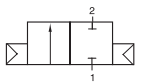

Enkelwerkend axiaalventiel met gasdraad, FPM, NC

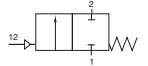

Doorlaat[mm] aansluiting[mm]		max. druk [bar] PN	Stuur- druk	Flens	Func- tie	Kv	Inbouwmaat [mm] en gewicht [kg]							Bestelcode
DN	Rp						A	B	C	D	SW	E	Gewicht	
10	3/8	16	3-8	NAMUR	EWNC	6,9	98	46	31	54	22	45	0,80	3PAV20200110
15	1/2	16	3-8	NAMUR	EWNC	8,8	112	52	33	59	26,5	45	1,00	3PAV20200115
20	3/4	16	3-8	NAMUR	EWNC	11,4	135	64	38	70	32	45	1,50	3PAV20200120
25	1	16	3-8	NAMUR	EWNC	14,5	143	69	41	76	41	45	1,92	3PAV20200125
32	1.1/4	16	3-8	NAMUR	EWNC	27,9	165	86	49	92	50	45	3,06	3PAV20200130
40	1.1/2	16	3-8	NAMUR	EWNC	48,8	180	96	54	102	56	45	3,76	3PAV20200135
50	2	16	3-8	NAMUR	EWNC	68,9	207	108	60	114	70	45	4,71	3PAV20200140

Enkelwerkend axiaalventiel met gasdraad, FPM, NO

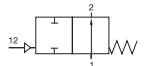

Doorlaat[mm] aansluiting[mm]		max. druk [bar] PN	Stuur- druk	Flens	Func- tie	Kv	Inbouwmaat [mm] en gewicht [kg]							Bestelcode
DN	Rp						A	B	C	D	SW	E	Gewicht	
10	3/8	16	3-8	NAMUR	EWNO	6,9	98	46	31	54	22	45	0,80	3PAV20200210
15	1/2	16	3-8	NAMUR	EWNO	8,8	112	52	33	59	26,5	45	1,00	3PAV20200215
20	3/4	16	3-8	NAMUR	EWNO	11,4	135	64	38	70	32	45	1,50	3PAV20200220
25	1	16	3-8	NAMUR	EWNO	14,5	143	69	41	76	41	45	1,92	3PAV20200225
32	1.1/4	16	3-8	NAMUR	EWNO	27,9	165	86	49	92	50	45	3,06	3PAV20200230
40	1.1/2	16	3-8	NAMUR	EWNO	48,8	180	96	54	102	56	45	3,76	3PAV20200235
50	2	16	3-8	NAMUR	EWNO	68,9	207	108	60	114	70	45	4,71	3PAV20200240

Dubbelwerkend axiaalventiel met gasdraad, EPDM

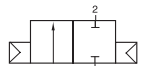

Doorlaat[mm] aansluiting[mm]		max. druk [bar] PN	Stuur- druk	Flens	Func- tie	Kv	Inbouwmaat [mm] en gewicht [kg]							Bestelcode
DN	Rp						A	B	C	D	SW	E	Gewicht	
10	3/8	16	3-8	NAMUR	DW	6,9	98	46	31	54	22	45	0,80	3PAV20000010
15	1/2	16	3-8	NAMUR	DW	8,8	112	52	33	59	26,5	45	1,00	3PAV20000015
20	3/4	16	3-8	NAMUR	DW	11,4	135	64	38	70	32	45	1,50	3PAV20000020
25	1	16	3-8	NAMUR	DW	14,5	143	69	41	76	41	45	1,92	3PAV20000025
32	1.1/4	16	3-8	NAMUR	DW	27,9	165	86	49	92	50	45	3,06	3PAV20000030
40	1.1/2	16	3-8	NAMUR	DW	48,8	180	96	54	102	56	45	3,76	3PAV20000035
50	2	16	3-8	NAMUR	DW	68,9	207	108	60	114	70	45	4,71	3PAV20000040

Enkelwerkend axiaalventiel met gasdraad, EPDM, NC

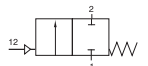

Doorlaat[mm] aansluiting[mm]		max. druk [bar] PN	Stuur- druk	Flens	Func- tie	Kv	Inbouwmaat [mm] en gewicht [kg]							Bestelcode
DN	Rp						A	B	C	D	SW	E	Gewicht	
10	3/8	16	3-8	NAMUR	EWNC	6,9	98	46	31	54	22	45	0,80	3PAV20000110
15	1/2	16	3-8	NAMUR	EWNC	8,8	112	52	33	59	26,5	45	1,00	3PAV20000115
20	3/4	16	3-8	NAMUR	EWNC	11,4	135	64	38	70	32	45	1,50	3PAV20000120
25	1	16	3-8	NAMUR	EWNC	14,5	143	69	41	76	41	45	1,92	3PAV20000125
32	1.1/4	16	3-8	NAMUR	EWNC	27,9	165	86	49	92	50	45	3,06	3PAV20000130
40	1.1/2	16	3-8	NAMUR	EWNC	48,8	180	96	54	102	56	45	3,76	3PAV20000135
50	2	16	3-8	NAMUR	EWNC	68,9	207	108	60	114	70	45	4,71	3PAV20000140

Enkelwerkend axiaalventiel met gasdraad, EPDM, NO

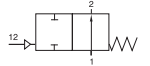

Doorlaat[mm] aansluiting[mm]		max. druk [bar] PN	Stuur- druk	Flens	Func- tie	Kv	Inbouwmaat [mm] en gewicht [kg]							Bestelcode
DN	Rp						A	B	C	D	SW	E	Gewicht	
10	3/8	16	3-8	NAMUR	EWNO	6,9	98	46	31	54	22	45	0,80	3PAV20000210
15	1/2	16	3-8	NAMUR	EWNO	8,8	112	52	33	59	26,5	45	1,00	3PAV20000215
20	3/4	16	3-8	NAMUR	EWNO	11,4	135	64	38	70	32	45	1,50	3PAV20000220
25	1	16	3-8	NAMUR	EWNO	14,5	143	69	41	76	41	45	1,92	3PAV20000225
32	1.1/4	16	3-8	NAMUR	EWNO	27,9	165	86	49	92	50	45	3,06	3PAV20000230
40	1.1/2	16	3-8	NAMUR	EWNO	48,8	180	96	54	102	56	45	3,76	3PAV20000235
50	2	16	3-8	NAMUR	EWNO	68,9	207	108	60	114	70	45	4,71	3PAV20000240

Dubbelwerkend axiaalventiel met gasdraad, NBR

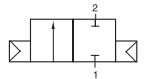

Doorlaat[mm] aansluiting[mm]		max. druk [bar] PN	Stuur- druk	Flens	Func- tie	Kv	Inbouwmaat [mm] en gewicht [kg]							Bestelcode
DN	Rp						A	B	C	D	SW	E	Gewicht	
10	3/8	16	3-8	NAMUR	DW	6,9	98	46	31	54	22	45	0,80	3PAV20100010
15	1/2	16	3-8	NAMUR	DW	8,8	112	52	33	59	26,5	45	1,00	3PAV20100015
20	3/4	16	3-8	NAMUR	DW	11,4	135	64	38	70	32	45	1,50	3PAV20100020
25	1	16	3-8	NAMUR	DW	14,5	143	69	41	76	41	45	1,92	3PAV20100025
32	1.1/4	16	3-8	NAMUR	DW	27,9	165	86	49	92	50	45	3,06	3PAV20100030
40	1.1/2	16	3-8	NAMUR	DW	48,8	180	96	54	102	56	45	3,76	3PAV20100035
50	2	16	3-8	NAMUR	DW	68,9	207	108	60	114	70	45	4,71	3PAV20100040

Enkelwerkend axiaalventiel met gasdraad, NBR, NC

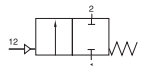

Doorlaat[mm] aansluiting[mm]		max. druk [bar] PN	Stuur- druk	Flens	Func- tie	Kv	Inbouwmaat [mm] en gewicht [kg]							Bestelcode
DN	Rp						A	B	C	D	SW	E	Gewicht	
10	3/8	16	3-8	NAMUR	EWNC	6,9	98	46	31	54	22	45	0,80	3PAV20100110
15	1/2	16	3-8	NAMUR	EWNC	8,8	112	52	33	59	26,5	45	1,00	3PAV20100115
20	3/4	16	3-8	NAMUR	EWNC	11,4	135	64	38	70	32	45	1,50	3PAV20100120
25	1	16	3-8	NAMUR	EWNC	14,5	143	69	41	76	41	45	1,92	3PAV20100125
32	1.1/4	16	3-8	NAMUR	EWNC	27,9	165	86	49	92	50	45	3,06	3PAV20100130
40	1.1/2	16	3-8	NAMUR	EWNC	48,8	180	96	54	102	56	45	3,76	3PAV20100135
50	2	16	3-8	NAMUR	EWNC	68,9	207	108	60	114	70	45	4,71	3PAV20100140

Enkelwerkend axiaalventiel met gasdraad, NBR, NO

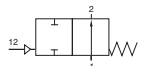

Doorlaat[mm] aansluiting[mm]		max. druk [bar] PN	Stuur- druk	Flens	Func- tie	Kv	Inbouwmaat [mm] en gewicht [kg]							Bestelcode
DN	Rp						A	B	C	D	SW	E	Gewicht	
10	3/8	16	3-8	NAMUR	EWNO	6,9	98	46	31	54	22	45	0,80	3PAV20100210
15	1/2	16	3-8	NAMUR	EWNO	8,8	112	52	33	59	26,5	45	1,00	3PAV20100215
20	3/4	16	3-8	NAMUR	EWNO	11,4	135	64	38	70	32	45	1,50	3PAV20100220
25	1	16	3-8	NAMUR	EWNO	14,5	143	69	41	76	41	45	1,92	3PAV20100225
32	1.1/4	16	3-8	NAMUR	EWNO	27,9	165	86	49	92	50	45	3,06	3PAV20100230
40	1.1/2	16	3-8	NAMUR	EWNO	48,8	180	96	54	102	56	45	3,76	3PAV20100235
50	2	16	3-8	NAMUR	EWNO	68,9	207	108	60	114	70	45	4,71	3PAV20100240